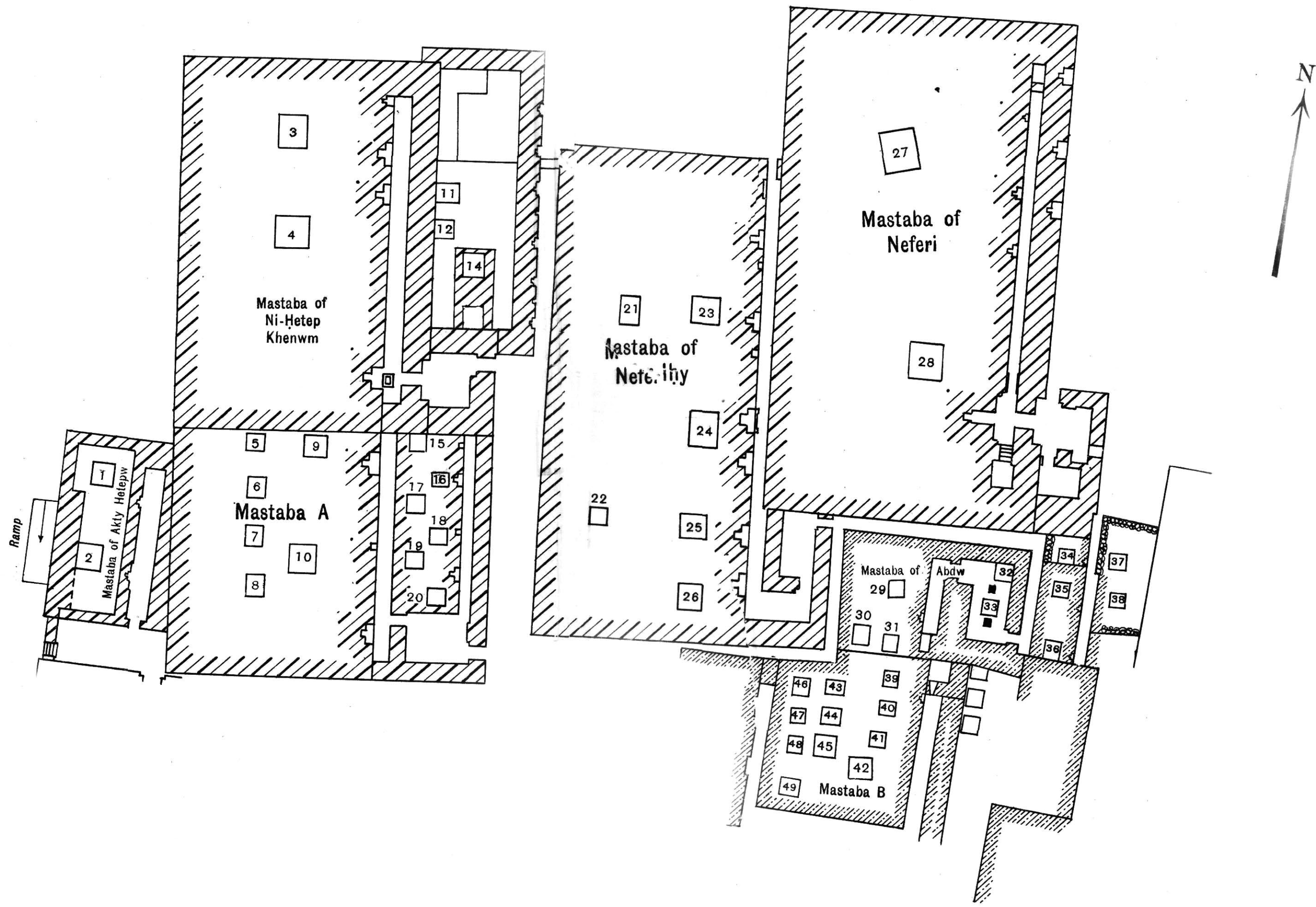
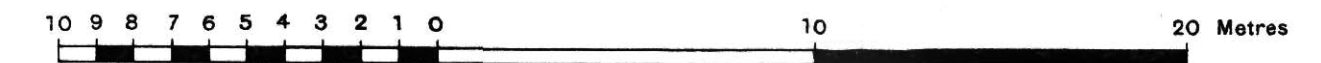


ALEXANDRIA UNIVERSITY EXCAVATIONS


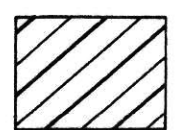
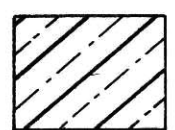

AT GIZA
WESTERN CEMETERY

1949-1950

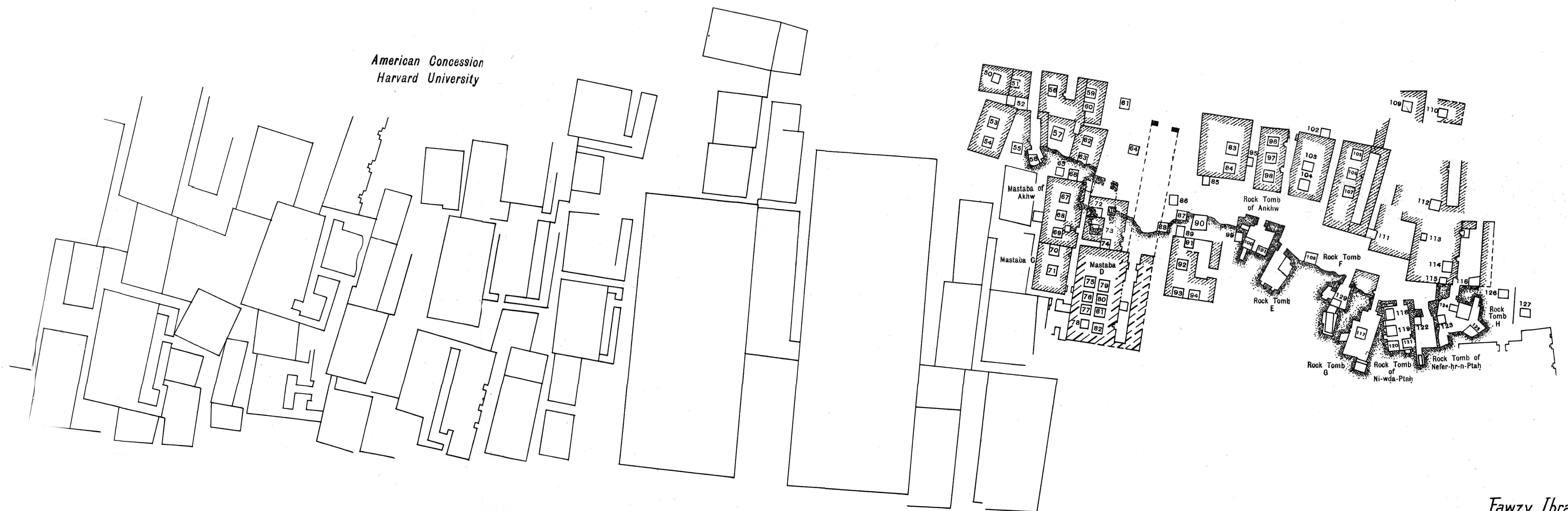
SCALE 1:200



REFERENCE

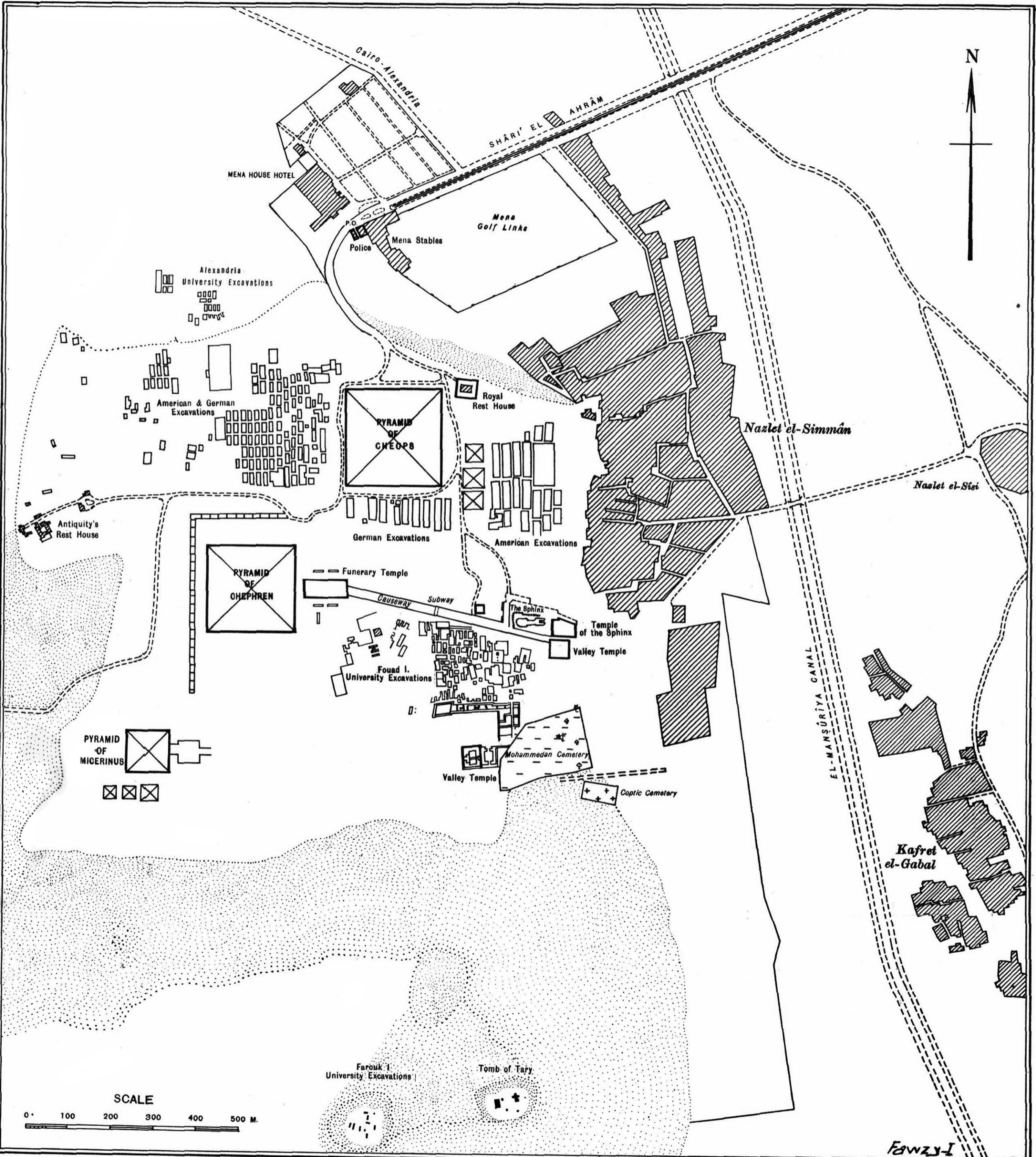
-  Natural Rock
-  Mud Brick
-  Stone
-  Gravel

American Concession
Harvard University



Fawzy Ibrahim

SITE PLAN OF GIZA NECROPOLIS



IRMBP

THE UNIVERSITY OF ALEXANDRIA

FACULTY OF ARTS

**EXCAVATIONS
AT GIZA
1949-1950**

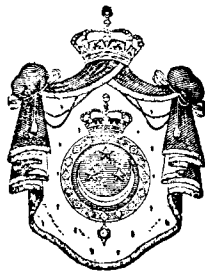
by

Prof. Dr. ABDEL-MONEIM ABU-BAKR

With a Chapter on "Brick Vaults and Domes
in the Giza Necropolis"

by

Dr. ALEXANDER BADAWEY



GOVERNMENT PRESS, CAIRO
1953

[This page is intentionally blank.]

PREFACE

The most important part of the Giza Necropolis is the so-called Western Cemetery, a group of huge Mastabas built to the west of the Great Pyramid. In 1902, the Hearst Expedition of the University of California excavated the northern strip of that part. In 1905, the Harvard-Boston Expedition took over the work which lasted until 1946. Owing to the death of the great Archæologist Dr. Reisner, the Expedition stopped its work and since 1949, the north-western strip of the concession has been granted to the University of Alexandria. Since then I have been working on this field.

The ancient and modern research in this site was fully described by Reisner in his "History of the Giza Necropolis", 1942, Vol. I, Chapter III, pp. 20-26. The present volume is, therefore, devoted to the results of my first season of work which began on December 15, 1949 and ended on May 25, 1950. The work was carried out on two sections: the first, next to the great Mastaba known to archæologists as G. 2000; the second, 500 metres to the west of that Mastaba. The first section has brought to light many rock-tombs, mostly uninscribed; the second has yielded many large Mastabas, mostly inscribed. The reader will notice in the description of these Mastabas, that I have followed Dr. Reisner's classification into different types given in his above-mentioned work.

In the preparation of the present volume, I was aided by many of my assistants whose share in the work is highly appreciated. Apart from the chapter written by my colleague Dr. Alexander Badawy on "Brick Vaults and Domes in the Giza Necropolis", I wish to express my thanks to him for drawing the plans of some of the tombs and the three coloured figures Nos. 16, 17 and 18. My sincere thanks are also due to Fawzi Ibrahim, the Architect of the Antiquities Department for drawing all the plans including the general and that of the site, and for the patience and painstaking work which he has given in preparing this volume in the Press. The inscriptions and the painted drawings of the false-door of the Mastaba of *Ni-htp-hnmw* were accomplished by the able draughtsman Ahmad Sidky and printed by Joseph Minerbo & Co.

I wish also to express my gratitude to my assistant Samy Shenuda for the great trouble he took in the work in the field and for keeping up the diary. The photographs were taken by Bashir Shadūf, one of our well-trained Kuftis. Rais Ali Abu-Hussein and Rais Moussa Khalil Hassan, two other Kuftis, were in charge of the workmen. These were chosen from the village of Nazlet el-Samman near the Pyramids.

I owe a special debt of gratitude to Professor Mustafa Amer, the Rector of the University of Alexandria and to Professor Muhammad Khalafallah, the Dean of the Faculty of Arts for the great enthusiasm they have shown for the work and the persistent encouragement they have given to me and which enables me to carry it through.

Finally, I have to thank the staff of the Government Press for their valuable services, in particular Hassan Klewa, the Director, for the facilities he was kind to offer; also my appreciation of the work of Hassan Munib in reading the first proof and for the production of the book, William Abdel-Sayed and Abbas Hassan for supervising the work in the Press.

THE PYRAMIDS, *December 3, 1952*

ABDEL-MONEIM ABU BAKR

[This page is intentionally blank.]

CONTENTS

	PAGE
PREFACE	III
MASTABA OF <i>3htj-htpw</i>	1
MASTABA OF <i>Ni-htp-hnmw</i>	11
UNINSCRIBED MASTABA "A", SOUTH OF MASTABA OF <i>Ni-htp-hnmw</i>	27
MASTABA OF <i>Nfr-i-hi</i>	31
MASTABA OF <i>Nfr</i> ²	39
MASTABA OF <i>3bdw</i>	69
UNINSCRIBED MASTABA "B"	83
MASTABA OF <i>3hw</i>	87
UNINSCRIBED MASTABA "C"	91
TOMB "D" WITH VAULTED CORRIDOR	93
ROCK-TOMB OF <i>Nhw</i>	95
ROCK-TOMB "E"	97
ROCK-TOMB "F"	99
ROCK-TOMB "G"	101
ROCK-TOMB OF <i>Nj-wd3-Pth</i>	103
ROCK-TOMB OF <i>Nfr-hr-n-Pth</i>	121
SARCOPHAGUS ROCK-TOMB "H"	125
BRICK VAULTS AND DOMES IN THE GIZA NECROPOLIS	129
INDEX OF TITLES	145

[This page is intentionally blank.]

LIST OF PLATES

SITE PLAN OF GIZA NECROPOLIS.

THE UNIVERSITY OF ALEXANDRIA EXCAVATIONS AT GIZA.

THE MASTABA OF *zhtj-htpw*

- PLATE I. Steps, court and entrance to the chapel.
- PLATE II. Chapel with the remaining parts of the vault.
- PLATE III. The western side of the Mastaba with the ramp.
- PLATE IV. Southern false-door.
- PLATE V. *A.*—Two canopic jars found in Shaft No. 1.
B.—Northern false-door.

THE MASTABA OF *Ni'-htp-hnmw*

- PLATE VI. General view—east side.
- PLATE VII. *A.*—Drum above the entrance.
B.—Offering-table in front of the false-door.
- PLATE VIII. *A.*—Upper part of the false-door.
B.—False-door.
- PLATE IX. *A.*—Upper lintel.
B.—Middle part of the tablet.
- PLATE X. *A.*—Left side of the tablet.
B.—Right side of the tablet.
- PLATE XI. Right-hand outer jamb.
- PLATE XII. Left-hand outer jamb.
- PLATE XIII. *A.*—Left door jamb of the recess.
B.—Right door jamb of the recess.
- PLATE XIV. Inner panel of the recess.
- PLATE XV. *A.*—Drum of *Khenti*.
B.—Lintel of *Ni'-htp-hnmw*.
C.—Drum of *Ni'-htp-hnmw*.

UNINSCRIBED MASTABA "A"

- PLATE XVI. General view—east side.
- PLATE XVII. Vaulted room.

THE MASTABA OF *ıbdw*

- PLATE XXXVI. Entrance of the chapel.
PLATE XXXVII. Lintel and right jamb of the entrance.
PLATE XXXVIII. Lintel over the entrance door.
PLATE XXXIX. The chapel before reconstruction.
PLATE XL. The chapel after reconstruction.
PLATE XLI. A.—Northern pillar—west face.
B.—Southern pillar—north face.

UNINSCRIBED MASTABA " B "

- PLATE XLII. A.—Skeleton showing kyphosis (hunch-back) of the spine.
B.—Part of vertebral column showing collapse of 10 and 12 vertebræ.
PLATE XLIII. Photographs of vertebral bodies, some showing compression and some osteophytic changes.
PLATE XLIV. The vertebral column showing collapse of 10 and 12 vertebræ.

THE MASTABA OF *ıhw*

- PLATE XLV. East side of the Mastaba.
PLATE XLVI. A.—Upper part of the false-door.
B.—Upper part of the false-door found near the Mastaba.
C.—Lintel found near the Mastaba.
PLATE XLVII. False-door and serdab.
PLATE XLVIII. Statues in the serdab.
PLATE XLIX. A.—Statues in the serdab.
B.—The incense pot found in the serdab.
PLATE L. A.—Statue of *ıhw*.
B.—Statue of *ıhw*.
PLATE LI. Statue of *ıhw*.
PLATE LII. Statue of *Nfrt*.

UNINSCRIBED MASTABA " C "

- PLATE LIII. Kiss scene of the eastern façade of Mastaba " C "

TOMB " D "

- PLATE LIV. A.—General view—north side of the Mastaba.
B.—Part of the vaulted roof.

THE ROCK TOMB OF 'Nḥw

PLATE LV. Drum above the entrance.

ROCK-TOMB " E "

PLATE LVI. A.—The bank-like superstructure of the shaft.

B.—The body found buried in the shaft.

THE ROCK-TOMB OF Nj-wd3-Pth

PLATE LVII. A.—Stela above the entrance-door.

B.—Scene on the east wall.

PLATE LVIII. A.—Serdab—blocked by limestone slabs.

B.—Statues in the serdab.

C.—Offering-table of Wr-R'.

PLATE LIX. A and B.—Statue of Wr-R'.

PLATE LX. Statue of a female grinding grain.

PLATE LXI. A.—Two figures hewn in the north wall.

B.—Three figures hewn in the west wall.

PLATE LXII. A.—False-door—west wall.

B.—Figure hewn in the rock—southern part of the west wall.

PLATE LXIII. A.—Two false-doors—west wall.

B.—Stand of the incense pot in situ.

PLATE LXIV. Scene on the west wall.

PLATE LXV. Scenes of servants on duty. From the west wall.

THE ROCK-TOMB OF Nfr-ḥr-n-Pth

PLATE LXVI. A.—Drum above the entrance.

B.—Scene on the right jamb.

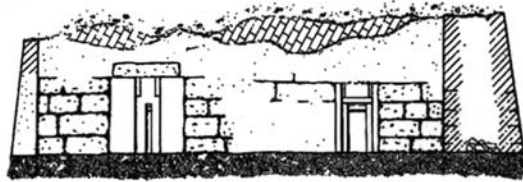
PLATE LXVII. A.—Scene on the east wall.

B.—Scene on the left jamb.

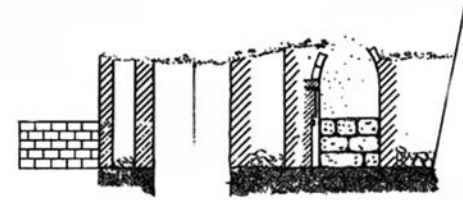
THE SARCOPHAGUS ROCK-TOMB " H "

PLATE LXVIII. Interior of the rock-tomb.

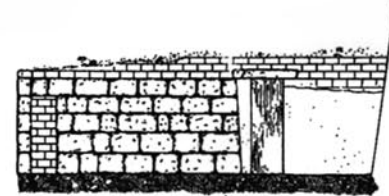
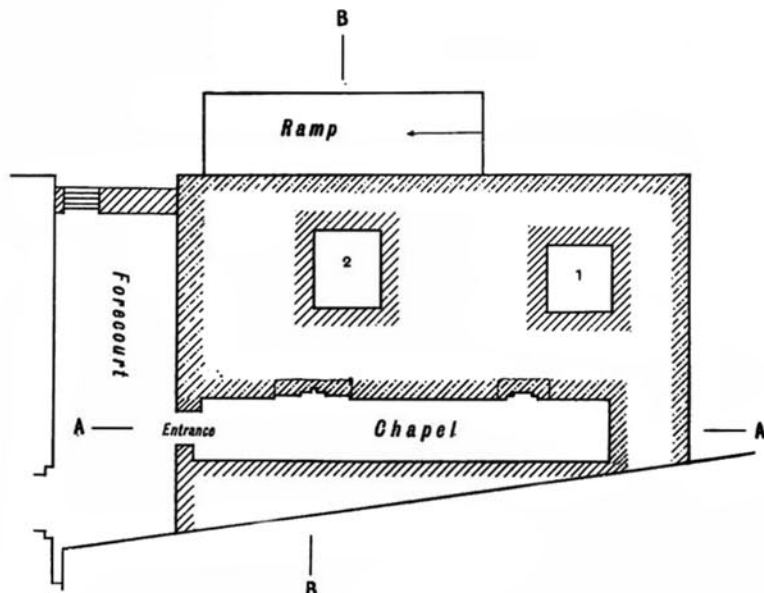
MASTABA OF AKHTY-HETEPW



Section A A







Section B B



South Elevation

REFERENCE

-  Natural Rock
-  Mud Brick
-  Stone
-  Plaster

SCALE
0 1 2 3 4 5 Metres


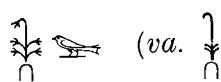


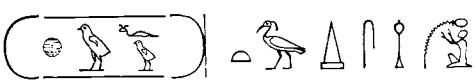






Fawzy Ibrahim

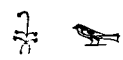


Fig. 1

MASTABA OF 3HTJ-HTPW

TITLES

1.  *imšhw-hr-ntr-ʿ3* “The Honoured by the Great God (1)”.
2.  (va. ) *wr-md-šm'* “The Great One of the Ten of Upper Egypt (2)”.
3.  *rh-niswt* “Royal Acquaintance”.
4.  *šhd-w'bw-šht-hwfw* “Inspector of *w'b*-priests of the Pyramid, *šht-hwfw* (3)”.
5.  *hntj-nst* “The one in front of the Throne (4)”.
6.  *imj-r3-sr-(w)* “Overseer of the (Judicial) Officials”.
7.  *hrp-m-s3* “Director of the Members of a Phyle”.
8.  *hm-ntr-hwfw* “Priest of *Hwfw*”.

TITLES OF THE SON (5)

1.  *wr-md-šm'* “The Great One of the Ten of Upper Egypt”.
2.  *hks-ht* “Regent of a Castle (6)”.
3.  *šhd-hmw-ntr* “Inspector of the Priests (7)”.

(1) JUNKER, H., “Giza”, VI, 40, 42, 59, etc., VII, 34, 38, 136, etc., VIII, 51, 62, 70, 89, 90, etc.; PIRENNE, H., “*Histoire des Institutions et du droit privé de l'Ancienne Egypte*”, II, 69, 74, 90, etc.; III, 148, 163, 186, 203.

(2) JUNKER, H., *op. cit.*; I, 176, 240, III, 9, 10, 15, 142; VI, 21, 221; VII, 150, 199, 231; VIII, 111; PIRENNE, H., *op. cit.*, II, 44, 101; III, 11, 51; W.B., I; 329.

(3) *cf.* the same title in the Mastaba of *Nfri*.

(4) The title has not been identified yet, although Pirenne thinks it designates an official, whose function obliged him to be near the king for executing his laws; a function which seems to have deteriorated in the VIth Dynasty as did that of governor of a nome, *cf.* JUNKER, H., *op. cit.*, III, 9, 155, 204 (reads *nst-hntj.t, nst-hnt.t*), W.B. II, 323 “*Titel eines hoher Verwaltungsbeamter*”, PIRENNE, H.: *op. cit.*, II, 56, 158, 169; III, 73 “*qui est devant le trône*”.

(5) From the southern false-door, above the small figure of the eldest son.

(6) *cf.* the same title in the Mastaba of *Nfri*.

(7) JUNKER, H., *op. cit.*, III, 16, 161; IV, 5, 18, 20, 27; VI, 10, 12, 18. W.B., III, 89; PIRENNE, H., *op. cit.*, II, 37; III, 58 (reads, *hd-hm-ntr*) “*Prêtre supérieur*”.

DESCRIPTION

Adjoining the western side of the uninscribed Mastaba "A" of crude brick, lies the small Mastaba of *ḥtj-ḥtpw*. The plan is rectangular ($10.50 \times 6.50 \times$ height about 2 metres), see General Plan (Fig. 1, Pl. I).

The stone masonry was not used throughout the structure but to about 1.85 metres above ground level on the southern face and even lower on the northern and western sides. Crude brick was used for the remainder of the work, including the vaulted corridor running alongside the eastern side. The plan is of the corridor type chapel⁽¹⁾, with an entrance (70×60 cm.) at its southern end and two false-doors in its western wall.

An exposed area closed in by the southern side of this mastaba, by one end of the southern side of the uninscribed Mastaba "A" and by the northern side of an as yet unexcavated stone mastaba, was arranged as a forecourt by the building of a brick retaining wall at its western end, with a stone staircase leading up from the forecourt to the level of the ground outside.

THE CORRIDOR

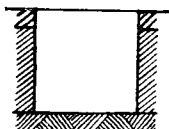
The corridor ($8.50 \times 1.10 \times$ height about 2.25 metres) is relatively wide and still retains part of the two sides of the vault which covered it. The vault is of the usual catenary type. The eastern side-wall is vertical and built in crude brick; the northern end-wall is built in the same stone masonry as the western side of the mastaba itself. At the southern end, a door opens into the forecourt. An uninscribed limestone lintel spans the opening (Pl. I).

Between the eastern side-wall of the corridor and the western side of the uninscribed mastaba, rubble stones were piled in as filling.

SHAFTS



Shaft No. 1 (Fig. 2): Dimension: $1.40 \times 1.40 \times$ depth 1.45 metres. Unfinished.



Shaft No. 2 (Fig. 1): Dimension: $1.55 \times 1.35 \times$ depth 9.50 metres.

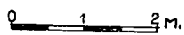


FIG. 2

The entrance to the burial-chamber (1×0.80 metres) was found blocked with three big limestone slabs; but the robbers, breaking into the chamber, removed one of the three slabs, which was found broken and thrown at the bottom of the shaft.

The chamber ($2.10 \times 1 \times 0.80$ metres) is just cut in the rock to contain the sarcophagus ($1.80 \times 0.45 \times 0.55$ metres), which is also hewn and deepened in the ground of the chamber. It has a lid of two big stone slabs. The robbers did not leave anything behind them except two canopic jars . . . , etc., of limestone, very roughly made and small in size (Pl. V-A).

(1) REISNER, G. A., "A History of the Giza Necropolis", 1942, p. 282, Fig. 178.

MATERIALS

The stone masonry is made of large blocks of nummulitic stones (40–65 cm.) × (32 × 40 × 33 cm.), with rosy plaster mortar in thick joints (1 cm.). The construction in masonry was stopped at a certain moment (1·80 metres above the forecourt level at the southern end and only 1·10 metres at the northern) and continued with bricks. The bricks are small (25–28 cm.) × (7–10 cm.) × (12–14 cm.) with irregular lime and sand mortar joints. Pebbles, flints, pottery and sherds are imbedded in the bricks themselves. Stone and brick faces are covered with a plastering of mud ($\frac{3}{4}$ cm.), a yellow plaster and sand, hatched straw and mud ($\frac{1}{4}$ – $\frac{1}{3}$ cm.) and are finished with whitewash.

THE RAMP TO THE WEST OF *ḥtj-ḥtpw* MASTABA (Figs. 3 and 4, Pl. III)

Along the western side of the mastaba itself a ramp (2·50 metres width northern side × 0·90 metre height northern side × 4·50 metres length) ascends from the southern end to a point 3·80 metres from the north-western corner⁽¹⁾.

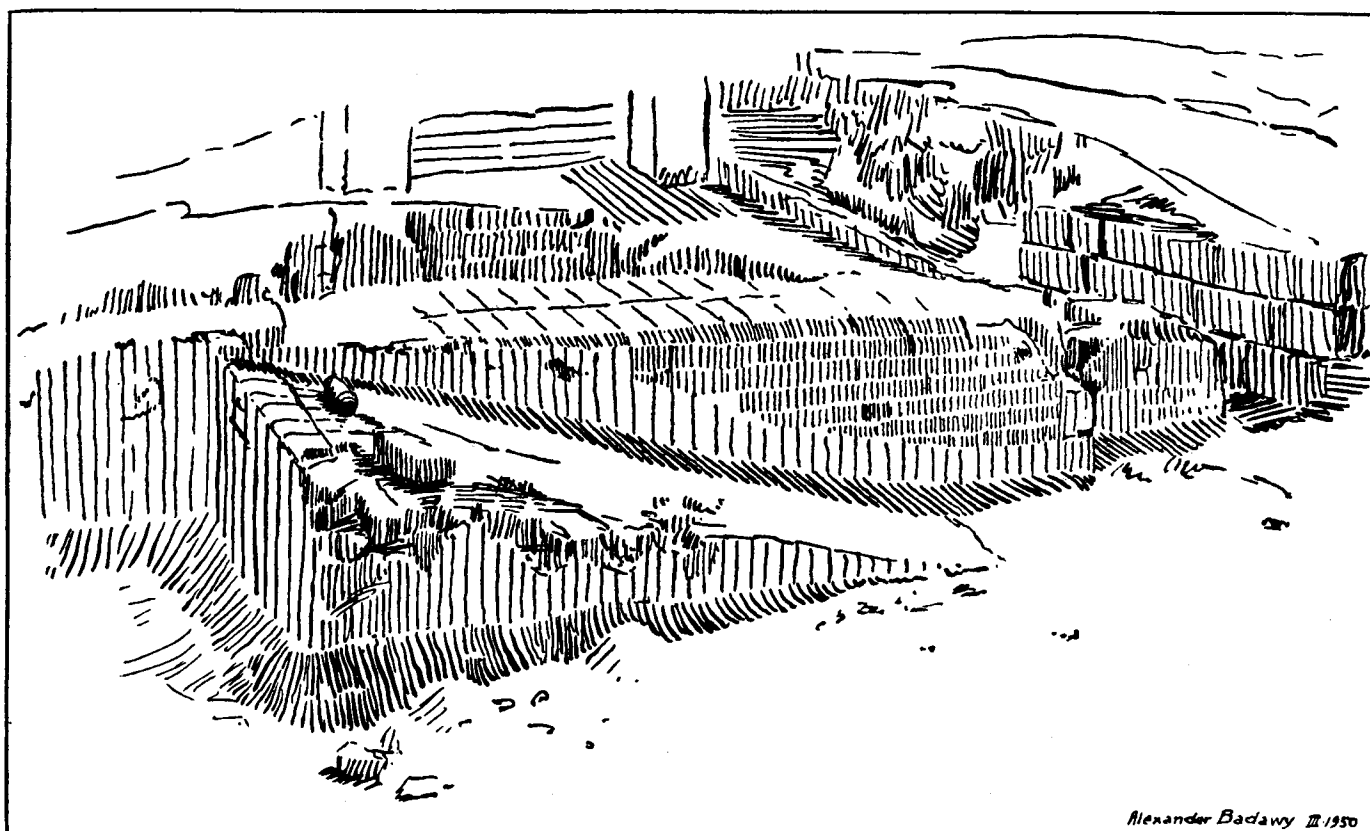


FIG. 3

It was found in a good state of preservation and had a retaining wall one brick (40 × 17 × height 11 cm.), abutting along the western side of the original structure which is built of smaller bricks (26 × 13 × height 8 cm.). This wall seems to be an enlargement to widen the ramp. The whole is plastered with mud (Fig. 3, Pl. III).

⁽¹⁾ The ramp along the eastern face of *Mrī* Mastaba ascends from north to south; cf. JUNCKER, H., "Giza", IX, Seite 4, Abb. 3.

The mastaba seems to have been topped with a parapet-wall, parts of which are still remaining on the southern and western sides on the latter; it stops at the end of the ramp, suggesting that there was a gap in it to allow entrance to the top level of the mastaba-area

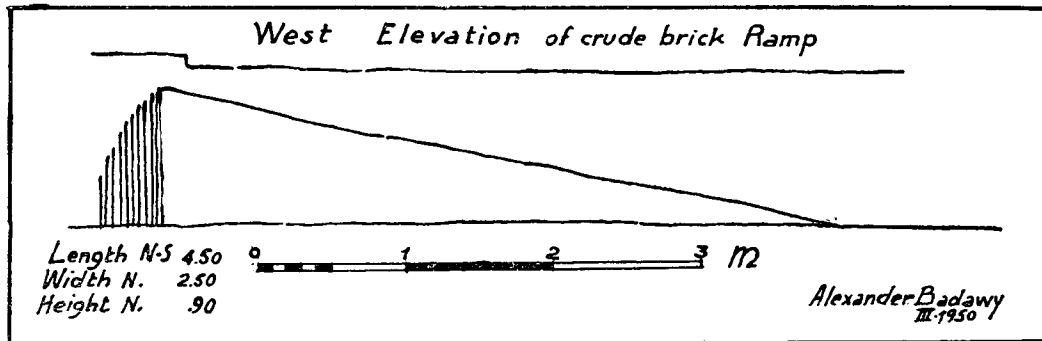


FIG. 4

at the mouth of the pits (Fig. 3, Pls. I and III). Such an element as a brick-ramp, fit to be used permanently, suggests the celebrating of certain rites upon the terrace of the mastaba. Our example, showing a doorway in the parapet that surrounds this terrace, clearly proves their use (1).


THE FALSE-DOORS

On the eastern side of the mastaba two false-doors are inserted, one towards the northern end and the other towards the southern (Pls. II, IV, V-B).


The southern, which is larger, consists of four parts: the lintel, the two jambs and the recessed back part. It is characterized by the very wide jambs, each having two vertical rows of large hieroglyphs, giving the titles and name of the deceased. At the bottom part of each jamb, the owner is represented in a walking attitude, facing the false-door and holding in one hand the *hrp*-sceptre, in the other the long stick. In both sides he is dressed in the wide kilt and the head is covered by a long-haired wig. Traces of colours are still visible. The stone of the false-door is of good white limestone, not polished but only hammered. The door is dedicated to *3htj-htpw*, his wife *hmt-3htj* (on the outer lintel) and the eldest-son *3htj-htpw* (on the left outer jamb).

Inscriptions occupy most of the area, while figures are shown on a small scale at the bottom of the façades of the outer jambs (Fig. 5, Pl. IV).

THE OUTER LINTEL

One line of hieroglyphs gives the offering formula:  "May the King be favourable and grant, may Anubis be favourable and grant that he be buried in the necropolis (2), *3htj-htpw* (3)".

(1) ERMAN, A., "Religion der Aegypter", p. 152; ERMAN-RANKE, "Aegypten", Abb. 155.

(2) The form of the necropolis-sign  is rather interesting.


(3) RANKE, H., "Die Aegyptischen Personennamen", Vol. I, p. 257, 26.

THE FAÇADE OF THE RIGHT OUTER JAMB

Two columns of hieroglyphs occupy the whole height of the jamb, save for the end of the second one, where, as already mentioned, the deceased is represented standing, his right arm holding the round-headed staff, his left, the sceptre which is almost entirely hidden behind him according to a distortion common in the Egyptian portrayal of figures. His head has a large wig and a short beard. A broad necklace adorns his breast and shoulders. He is dressed in a protruding triangular skirt with a looped girdle (1). He faces the axis of the door. The inscriptions are (Fig. 5, Pl. IV):—

(1)  "The inspector of the *w'b-*

Upper Egypt".

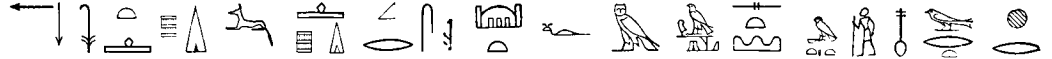
(2)  "The honoured one by the great god, (and) by Anubis, at the top of his mountain, lord of the necropolis, *shj-htpw* (2)".


The name *shj-htpw*, which seems to be inserted after the title *wr-md-šm'*, should normally be read at the end of the inscription.

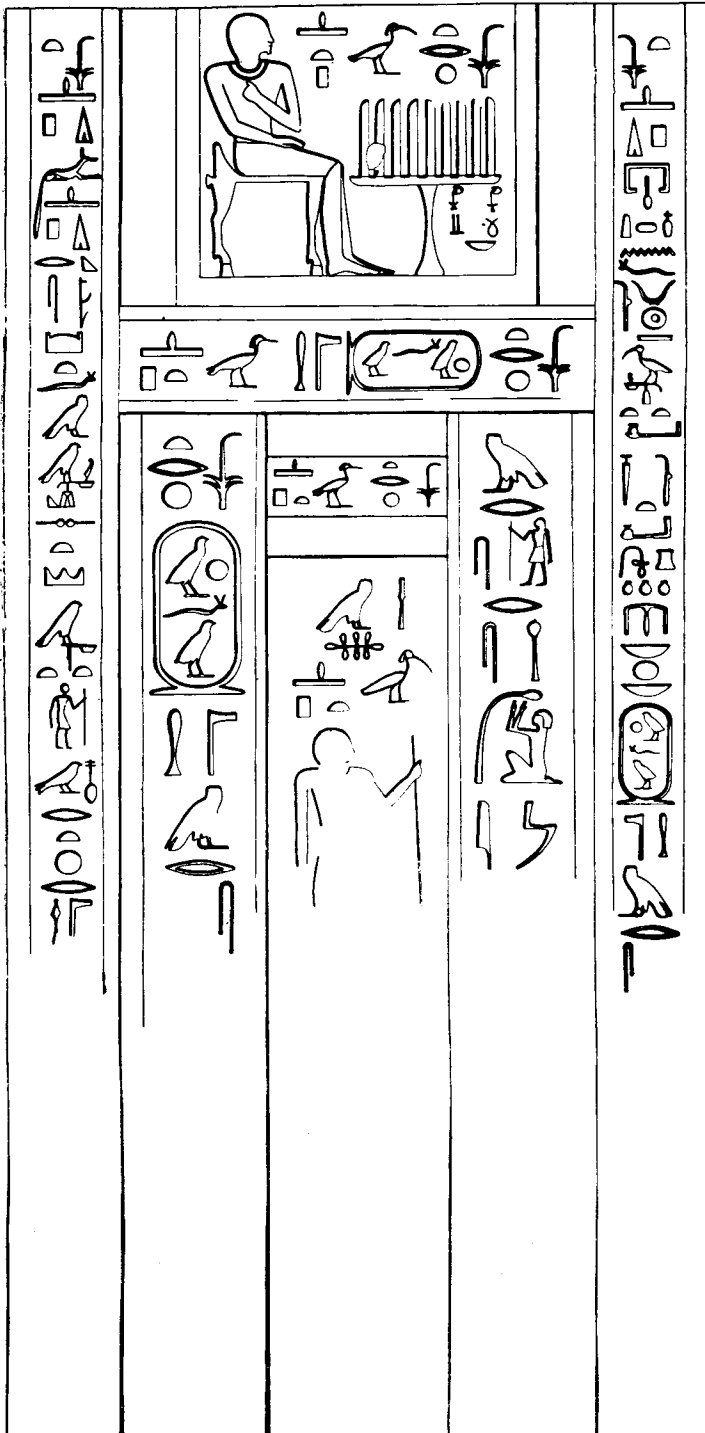
THE FAÇADE OF THE LEFT OUTER JAMB

Each of the hieroglyphs in the two columns of inscriptions is set at the same height as the corresponding one on the right-hand jamb. The same applies to the form of the hieroglyphs.

The northern false-door is smaller and nummulitic, and its bottom part is in a very bad state of preservation. It is of the type having the jambs doubled so that an outer recess topped with a tablet, frames the essential part of the false-door. The two outer jambs are narrow and each is inscribed with one column of the following hieroglyphs:—

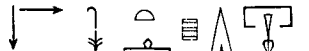
Left jamb: 

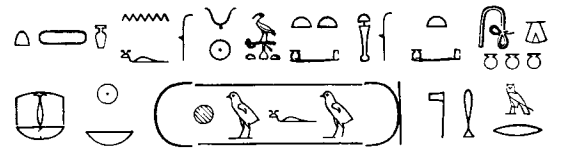
 "May the King be favourable and grant, may Anubis be favourable and grant that he be buried in the necropolis in the western cemetery after a very good old age, with the great god..." (Fig. 6, Pl. V-B).




0 10 20 c.m.

FIG. 6

Right jamb: 




 "May the King be favourable and give an offering to him at the festival of the opening of the year, at the festival of *Dhwty*, at the festival of the beginning of the year, at the *wsg*-festival, at every festival and on every day, the priest of *Hwfw*, the overseer of the (officials) . . .".

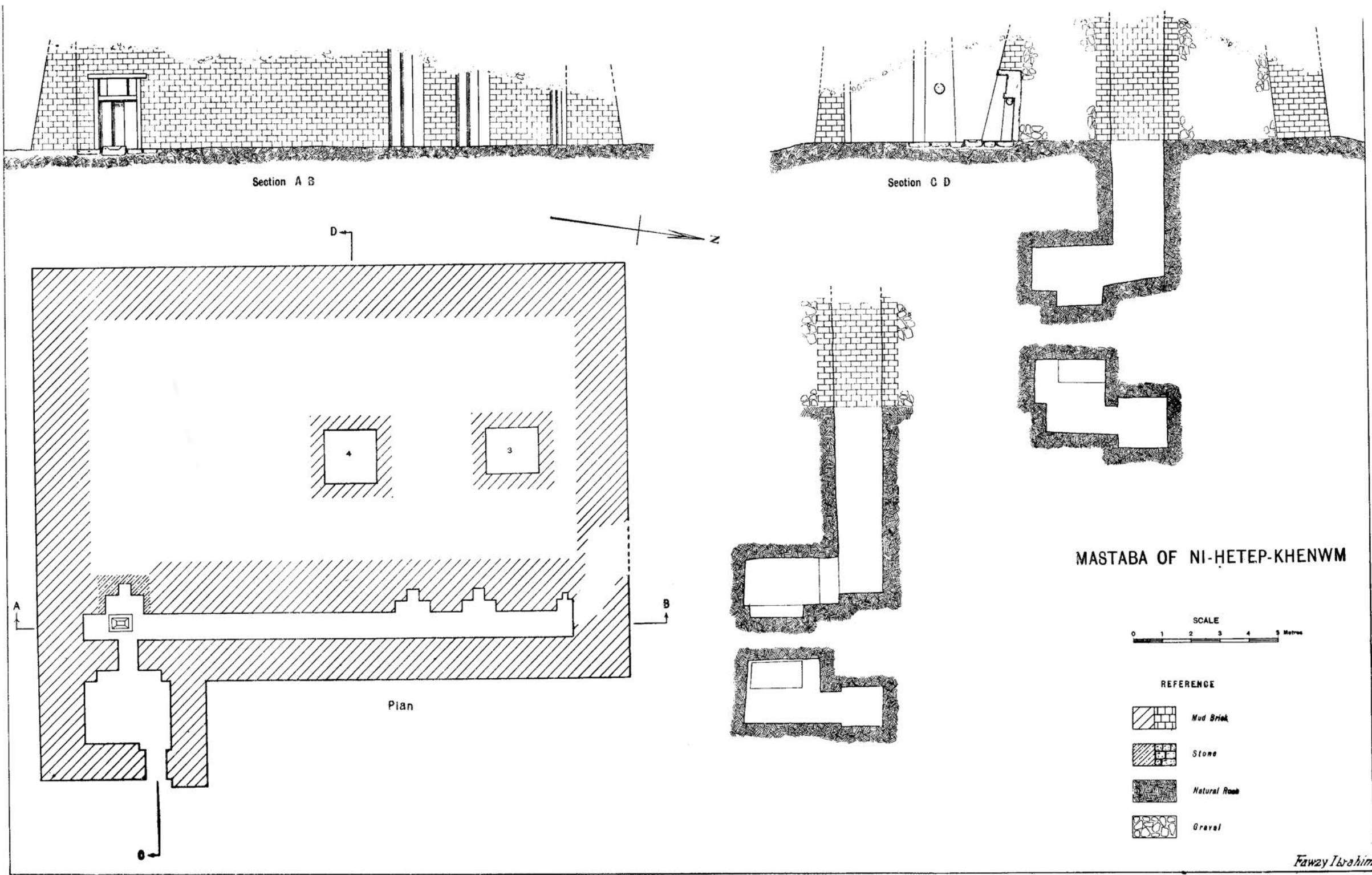
The lintel is slightly recessed with respect to the two jambs and bears one single line of inscriptions:



 "The royal acquaintance, priest of *Hwfw*, *zhtj-htpw*".

Above the lintel, the square tablet, more deeply recessed than the lintel, is carved with the scene of the deceased seated in front of the offering-table. The left arm is bent over the breast, while the right is extended on the lap. He wears a short kilt, a graded wig, and, around the neck, a broad necklace. In front of his face is a horizontal line of hieroglyphs, reading: 
 "The royal acquaintance, *zhtj-htpw*".

[This page is intentionally blank.]



MASTABA OF NI-HETEP-KHENWM

SCALE
0 1 2 3 4 5 Metres


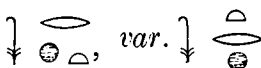
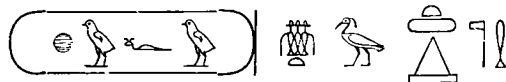
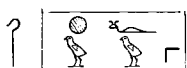

- REFERENCE
-  Mud Brick
 -  Stone
 -  Natural Rock
 -  Gravel

Fawzy Ibrahim


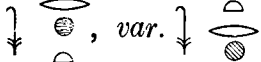
FIG. 7

MASTABA OF NI-ḤTP-ḤNMW⁽¹⁾




TITLES

1.  *nb-ḥm-ḥr-ntr-ʿ3* "Possessor of honour before the great god⁽²⁾".
2.  *rh-ni'swt* "Royal acquaintance⁽³⁾".
3.  *ḥm-ntr-Ḥnt-ḥt-Ḥwfw* "Priest of the (vestibule) of the pyramid, *ḥt-Ḥwfw*⁽⁴⁾".
4.  *ḥk3-Ḥt-Ḥwfw* "Regent of the castle of *Ḥwfw*".
5.  *šḥd-w'bw* "Inspector of *w'b*-priests⁽⁵⁾".

TITLES OF *Ḥnti*

1.  *mītrt*⁽⁶⁾ "Concubine (?)".
2.  *rḥt nswt* "Royal acquaintance⁽⁷⁾".

TITLES OF OTHER PERSONS

1. *Twī*:  "Royal acquaintance".
2. *Ḥa-nefert-Kḥwfw*:  "Royal acquaintance".
3. *Pepi*:  "Scribe".

(1) cf. RANKE, H., "Personennamen" I, S, 173 "Ni-ḥtp-ḥnmw" = *Bisitzer von Gnade ist Chnum*.

(2) cf. Nfri, title No. 6.







(3) cf. Nfri, title No. 7.

(4) For *ḥnt*, cf. W.B. III, 302.

(5) JUNKER, H., *op. cit.*, VI, 15, 21, 76; PIRENNE, H., *op. cit.*, III, 205, 272, "Prêtre purificateur supérieur".

(6) JUNKER, H., *op. cit.*, V, 141, 146, VI, 179, 190, 202, 222, W.B. II, 45, "Frauentitel".


(7) JUNKER, H., *op. cit.*, III, 11, 12, 143, 173, 177, etc., IV, 7, "Nachkommin des Königs"; V, 18, 19, 56, 184; VI, 31, 42, 56, 97, "Königskenelin"; VII, 70, 95, 242, 244, 245; VIII, 20, 22, 124, 136, 175. PIRENNE, H., *op. cit.*, II, 72, III, 304, "connue du roi".

4. 'Aw:  "Elder of the House⁽¹⁾".
5. Ibbi:  "K3-priest⁽²⁾".
6. Seneb: (a)  "King's purificator".
 (b)  "Oarsman of the ship".
7. Hes:  "King's purificator".
8. Imen-Kaw-Khwfw:  "King's purificator".

DESCRIPTION

This mastaba is situated to the north of Mastaba "A" and to the west of that of *Nfr-ihii* (see General Plan). The plan is rectangular (20.60 × 14.50 × height about 3.75 metres) (Fig. 7, Pl. VI).

It is a rubble core of masonry of nummulitic stone, encased between crude brick retaining walls. The type, according to Reisner's classification, would be "core type VI". At the southern end of the eastern face, a small enclosure protrudes from the rectangular plan and is connected with the corridor running along the eastern face of the mastaba by a door, which lies in the axis of the main false-door.

This enclosure, almost square in plan (2.90 × 2.20 × height about 1.90 metres), is in crude brick of the same type as the mastaba itself, and its entrance door (width 0.70 × depth 1.05 metres) opens at the northern corner of its face. The doorway (width 0.70 × depth 1.10 × height 1.75 metres), connecting it with the corridor, is surmounted by a drum (Fig. 8, Pl. VII-A) which is inscribed:  "Royal acquaintance, regent of *Hwt-hwfw*, *Ni-htp-hnmw* . . .".

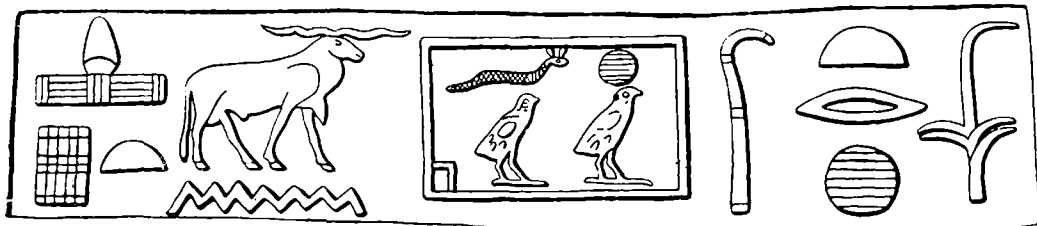


FIG. 8

0 5 10 c.m.

No evidence concerning the type of this enclosure was found. Was it an open court or a roofed room?

The corridor (17.00 × 0.90 × height 3.10 metres), which runs north of this chapel and along the eastern side of the mastaba, has battered walls sloping at different angles, plastered with mud and yellowish white gypsum, and whitewashed. Probably, though

(1) W.B. 515, JUNKER, H., *op. cit.*, III, 92, 97, 178; VI, 231.

(2) JUNKER, H., *op. cit.*, I, 241, 254, III, 118; IV, 95; V, 11; VI, 72, 98, 220; VIII, 87, 155. PIRENNE, H., *op. cit.*, II, 326 III, 273 "prêtre funéraire".

nothing has remained of it, the roof of the corridor was vaulted, as that of *Nfri'*, *Nfr-ihii'* and *ihj-htpw*. At the northern end of this corridor there are three recesses in the form of false-doors.

No traces of a serdab were found either in the corridor, or in the main false-door.

MATERIALS

The core is similar to that of *Nfri'*. The brickwork consists of alternating courses of headers and stretchers; dimension of the bricks being $12.50 \times 18 \times 38$ cm. The bricks are dark grey with a mortar of a much lighter colour, containing a high proportion of sand. The joints vary between 0.50 cm. and 2.50 cm.

The plastering is about 1 cm. thick in two layers. Over a yellow mortar of gypsum, containing a high proportion of hashed straw, a second greyish one about 0.75 cm. thick is laid. The whole is covered with a very thin coat of whitewash. This plastering, used in the outer enclosure, occurs also in much thicker layers on the walls of the corridor.

OFFERING-TABLE

In front and to the east of the main false-door is an offering-table inserted in the ground. This offering-table is basin-like in form. Its trapezium-shaped sides slope outwards from a narrow base up to the perpendicular edges of the broad upper surface. The surface is scooped out down to half the depth of the table, thus forming a hollow with trapezium-shaped sides and a flat bottom. Dimension: $80 \times 53 \times$ height 25 cm. (Fig. 9, Pl. VII-B).

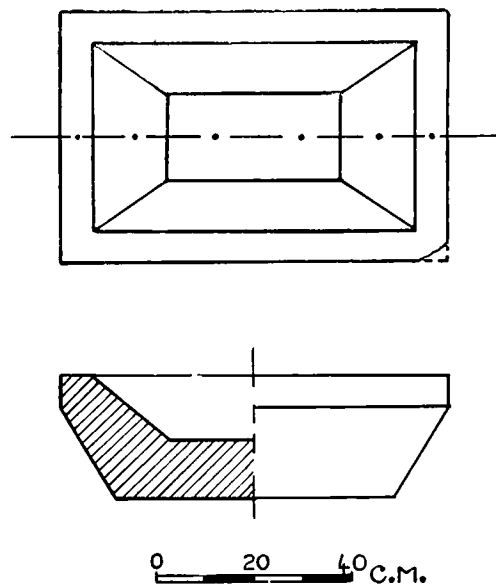


FIG. 9

SHAFTS

Shaft No. 3 (Fig. 7):

Dimension: $1.80 \times 1.60 \times$ depth 10.50 metres. The upper four metres are built up in mud-bricks, and the remainder is cut out of the rock itself. The entrance (0.75×1.10 metre) to the burial-chamber is in the southern side of the shaft. The chamber itself ($2.60 \times 2.25 \times$ height 1.70 metres) has a sarcophagus on its western side, cut in its floor out of the main rock ($1.75 \times 0.90 \times$ depth 0.40 metre). Nothing was found in the sarcophagus except some scattered bones. The lid is missing. There were no traces of canopic jars nor of the usual funerary objects.

Shaft No. 4 (Fig. 7):

Dimension: $1.80 \times 1.85 \times$ depth 9.85 metres. The upper four metres are built up in mud-bricks, the remainder is cut out of the rock. The entrance (0.50×1.00 metre) to the burial-chamber is in the southern side of the shaft and was found partly blocked with crude



Fig. 10

© 1925 by the Trustees of the British Museum

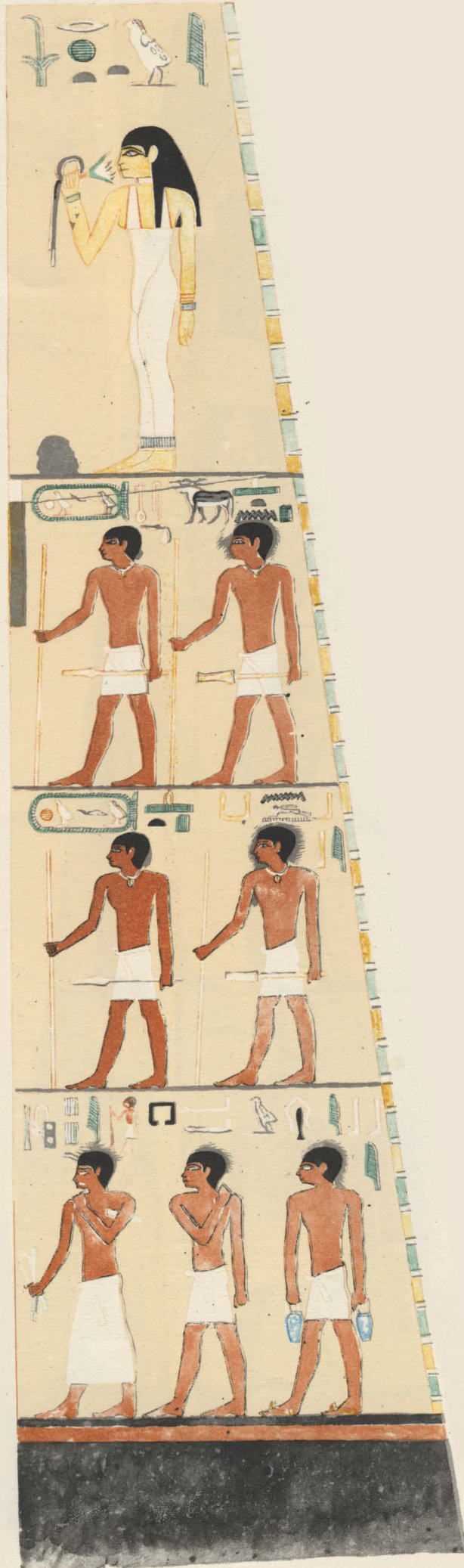



Fig. 11



Fig. 12

This formula is intended for the benefit of a woman, surely *Ḥnti*, the wife of the deceased ; she is represented on the left-hand inner jamb and on the tablet sitting in front of him and partaking of the offerings.


THE FACE OF THE OUTER LEFT-HAND JAMB (Fig. 10, Pl. VIII)

Parallel to the right column, the left jamb is inscribed with a column of hieroglyphs, giving a variant of the offering formula for the use of the deceased omitting the mention of the going-forth of *Min*-festival :  " May the King be favourable and grant that an offering comes forth for him on the first day of the month (at) the half-month, at the opening of the year festival, the beginning of the year festival, the *Dhutj*-festival, the *Wꜥg*-festival, every-day and at every festival "

THE SIDE OF THE RIGHT OUTER JAMB (Fig. 11, Pl. XI)

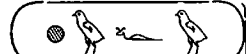

Four registers occupy the side of this jamb and represent standing figures facing the interior of the recess :—

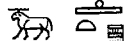
First (Top) Register :

A woman stands wearing a long wig and dressed in a long close-fitting dress. A neck-band, bracelets or wrist-bands, and anklets adorn her. Her right arm raises to her nose a lotus-flower with looped stem. Her left arm hangs by her side. The horizontal line of hieroglyphs gives her title and name :  (1) "The royal acquaintance, *Twi*".

Second Register :

Two men identical in all respects stand one behind the other facing the interior of the recess. They have short hair, are dressed in short kilts and wear one-string necklaces with central pendant. Each has his right arm extended in front of him, holding a long staff, while the left arm, hanging along the side, carries horizontally a *shm*-sceptre. The horizontal line of hieroglyphs gives the names of both (Pl. XI) :—

(1)   *Nfr-Sꜣm-Ḥwꜥw* (2).

(2)  *Ni-Ḥtp-Ḥnmw*.

(1) RANKE, H., *op. cit.*, p. 379.

(2) RANKE, H., *op. cit.*, p. 200.


Third Register :

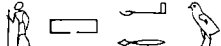
Two men similar to those of the second register, but somewhat more widely spaced, form the composition of this longer register. Their names read :—


(1)  |  *Htp-Hwfw* (1).

(2)  *K3-nbbi* (?) (2).

Fourth (Lowest) Register :

Three standing figures of men occupy the register and face the interior of the recess. The foremost is dressed in a long kilt, reaching down to just above the ankles. His hair is cut short and two reed-pens are stuck behind his right ear. His right arm is extended and the hand holds a palette and an inkpot. His left arm, crossed upon his breast, presses a roll of papyrus under the arm-pit, while the hand grasps the right shoulder. This is “the scribe *pepi*  (3) ”.

The man following, with short hair and dressed in a short kilt, holds his right arm crossed over his breast, the hand grasping his left shoulder, while the left arm is hanging down. He is named :  “The elder of the house, ‘*iw* (4) ”.

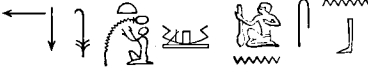
The third figure, similar to the others, carries in each hand a libation vessel and is the only one wearing sandals, a peculiarity due perhaps to his office of funeral priest :  “The *K3*-priest, *ibbi* (5) ”.

THE SIDE OF THE LEFT OUTER JAMP (Fig. 12, Pl. XII)


The entire side is divided into three horizontal registers, showing figures of standing personages, facing the interior of the recess :—

First (Top) Register :

A man wearing a short graded wig and dressed in a short kilt, stands holding a long staff in his extended left hand, and a *shm*-sceptre in his right. A band or bracelet adorns his right wrist.

He is :  “The king’s purificator, the oarsman of the royal (?) ship, *snb* ” (6)

(1) RANKE, H., *op. cit.*, p. 258.

(2) RANKE, H., *op. cit.*, p. 192, *K3(j)-nbj*; RANKE, H., *op. cit.*, p. 95, -*bbj*.


(3) RANKE, H., *op. cit.*, p. 131.


(4) RANKE, H., *op. cit.*, p. 58.

(5) RANKE, H., *op. cit.*, p. 21.


(6) RANKE, H., *op. cit.*, p. 312.


Second Register :

Two men walking, follow each other towards the interior of the recess. The first, wearing a short graded wig, and dressed in a short kilt, holds a long staff with his extended left arm, and with his right, bent over his breast, a sceptre resting upon his right shoulder. He wears a necklace, and a band or bracelet adorns his right wrist. He is :  "The royal *w'b*-priest, *Hs*(¹)".

He is followed by a man with short hair, dressed in a short kilt with a looped knot at the belt, and wearing a one-string necklace round his neck ; he holds with his left arm, which is bent over the breast, a long staff held vertically, the tip raised above the ground and coinciding with the frontal axis of the figure. In his hanging right arm he grasps horizontally a *shm*-sceptre. His name is :  "*whm-n* (*j*)-*K3* (*j*) (²)".

Third (Lowest) Register :

Only two figures appear, standing in a similar attitude, are differentiated by their equipment. The first man, dressed in a short kilt and with hair cut short, holds in his left arm a long staff and in his right, hanging along his side, a *shm*-sceptre. A one-string necklace with central pendant adorns his neck. He is :  "The king's purificator, *Imn-K3w-hwfw* (³)".

The second wears a short wig, a short beard and a leopard skin hung over his left shoulder ; the strap of this is engaged over the man's left elbow. A necklace is shown round this neck. He is named :  "*K3* (*j*)-*hr-stf* (⁴)".

THE TABLET

Surmounting the cross-bar, the tablet (square in shape) is carved with a scene representing the deceased on the left, seated on a stool and a woman on the right sitting on a similar stool ; between them is a small offering-table of the common type, with round tray on a conical stand, set higher than floor level (Fig. 10, Pl. IX-B).

The deceased wears a short graded wig adorned with a narrow hair band with double-looped knot at the back, a style (⁵) used also by *Nfri*. He wears a one-string necklace with a pendant (⁶) similar again to that of *Nfri*. A long dress is hung on the left shoulder, covering the left arm down to the wrist and reaching down to just above the ankles. His left hand holds

(¹) RANKE, H., *op. cit.*, p. 254.

(²) RANKE, H., *whmw-n-k (whmw-n-j)*, p. 83.

(³) The Kas of Cheops remains, *cf.* RANKE, H., *op. cit.*, p. 150.















(⁴) RANKE, H., *op. cit.*, p. 340.

(⁵) JUNKEB, H., *op. cit.*, V, abb. 13.

(⁶) JUNKEB, H., *op. cit.*, VII, abb. 181.

on to the knot on the left shoulder, as in the case of *Nfri*. A wrist-band adorns his right arm which is extended towards the offering-table.

The woman, who is possibly his wife (1), faces him and wears a long wig. Round the neck a band surmounts a necklace of many rows, the lowest of which has bead-shaped pendants. She is dressed in a long robe reaching just above the ankles and hung on two braces. Her right hand rests upon her left breast while her left arm stretches towards the table. Wide anklets adorn her legs. In the space above the tablet of offerings, the hieroglyphs, running from right to left, give some of the items which were set upon it :—

- | | | |
|------|---|---------------------------------------|
| (1) |  | “ White grain (2) ”. |
| (2) |  | “ <i>wḥ</i> -fruit (3) ”. |
| (3) |   | “ Wine (4) ”. |
| (4) |  | “ Black kohl (5) ”. |
| (5) |  | “ Green kohl (6) ”. |
| (6) |  | “ Incense (7) ”. |
| (7) |   | “ Strong beer of Thebes ” 2 jugs (8). |
| (8) |  | “ <i>išd</i> -fruit (9) ”. |
| (9) |  | “ Natron-water (10) ”. |
| (10) |  | “ <i>ḥdt</i> -drink (11) ”. |
| (11) |  | “ <i>prw</i> -drink (12) ”. |
| (12) |  | “ meat ”. |

(1) She is mentioned as a *mitri* “concubine” (v. inf.).

(2) B. VANDER WALLE, *op. cit.*, p. 69 : No. 80, cf. side of the left wall, outer recess of the *Nfri* false-door No. 16.

(3) cf. *Nfri* No. 18.

(4) cf. *ibid.*, No. 12.

(5) cf. *ibid.*, No. 4.

(6) cf. *Nfri* No. 3.

(7) *Ibid.*, No. 2.

(8) B. VANDER WALLE, *op. cit.*, pp. 65, 69, No. 65 and JUNKER H., *op. cit.*, VIII, 104, 121, 149.

(9) cf. *Nfri* No. 9.

(10) *Ibid.*, No. 8 and JUNKER, H., *op. cit.*, III, 103.

(11) *W.B.*, III, S. 211.

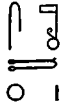


(12) *W.B.*, I, S. 531.

Three columns of hieroglyphs give three names of pieces of furniture which had their place probably in the sleeping room :—




1. Head-rest (*wrs*) (1).
2. Service-table (*dsrt*) (2).
3. Wooden-chest (*h3-ht*) (3).

To the left of the tablet three horizontal registers give a choice of some items of offerings (4) (Fig. 10, Pl. X-A).

First Register : These three items are also mentioned on the tablet :—

- | | | |
|-----|---|-------------------|
| (1) |  | “Incense (5)”. |
| (2) |  | “Green kohl (6)”. |
| (3) |  | “Black kohl (7)”. |

Second Register :—

- | | | |
|-----|---|------------------------------|
| (4) |  | “Best kind of ointment (8)”. |
| (5) |  | “Red-linen (9)”. |
| (6) |  | “Offering-table (10)”. |

Third Register : Names of items are disposed in two horizontal series :—

- | | | |
|-----|---|----------------------------|
| (7) |  | “ <i>isd</i> -fruit (11)”. |
|-----|---|----------------------------|

(1) *W.B.*, I, 335.

(2) *W.B.*, V, 617.

(3) *W.B.*, III, 12.

(4) For a similar disposition in registers, cf. JUNKER, H., *op. cit.*, V, 95.

(5) cf. Tablet No. 6, *Nfri*, No. 2.

(6) cf. Tablet No. 5, *Nfri*, No. 3.







(7) cf. Tablet No. 4, *Nfri*, No. 4.

(8) *W.B.*, III, 28; JUNKER, H., *op. cit.*, I, 229, 244. “*best Oel*”; III, 11, 16, 98, 99, V, 94, B. VANDER WALLB, *op. cit.*, p. 43.

(9) *W.B.*, V, 456.


(10) *W.B.*, III 226, very likely this is the word spelt *h3wt*.


(11) cf. *Nfri*, No. 9; occurs also on the neighbouring tablet, No. 8.

- (8)  "Figs (1)".
- (9)  "Nbs-fruit (2)".
- (10)  "Fruit-bread (3)".
- (11)  "Cake : 1 (4)".
- (12)  "Biscuit" (*ts-rtḥ*) (5)".
- (13)  "Every sweet thing" (*iḥt-nbt-bnrt*) (6).

A generic designation not uncommon at the end of an offering-list.


THE CROSS-BAR OR LINTEL IN THE RECESS

One line of hieroglyphs runs from right to left (Fig. 10, Pl. IX): 

 "The priest of the pyramid, *Ḥnt-ḥt-Ḥwfw*, the inspector of *w'b*-priests, *Ni-ḥtp-Ḥnmw*".

THE RIGHT DOOR-JAMB OF THE RECESS (Fig. 10, Pl. XIII-B)

The vertical panel is occupied by a scene representing a woman, the same who appeared on the tablet sitting in front of the deceased; here she is accompanied by a smaller figure. The woman is standing facing the axis of the door. She wears a long wig and the neck-band. Her right arm is crossed; the hand, adorned with a wrist-band resting upon her left breast, while the left arm, hanging along her body, carries a lotus-flower with a long looped stem. She is dressed in a long robe hung under the breasts by two shoulder-braces, and fitting tightly. Wide anklets adorn her legs. Above her head a horizontal line reads:

 "The royal acquaintance, *Ḥnti*".

(1) *Ibid.*, No. 19.


(2) *Ibid.*, No. 21.

(3) *Ibid.*, No. 6.


(4) *Ibid.*, No. 18.

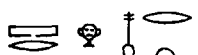
(5) *W.B.*, II, JUNKER, H., *op. cit.*, I, 244; III, 98; IV, 25, 88, V, 94, 96; VIII, 104, B. VANDER WALLR; *op. cit.*, p. 68, No. 21.

(6) B. VANDER WALLE, *op. cit.*, p. 70, No. 88, and JUNKER, H., *op. cit.*, III, abb. 22; IV, 26, No. 88; VI, 197; VII, 147; VIII, 103, 117, 149.

The smaller figure represents a girl, and reaches no higher than the leg of the large one. Her hair cut short, is adorned with a hair-band showing lotus-flowers. An ornamental band surrounds her neck and she is dressed in a long tight garment. In her right hand she grasps a huge lotus-flower with looped stem, while her left arm is passed behind the knees of the woman. Anklets adorn her feet. She is looking backwards, a conventional way of indicating that she is looking at the much taller figure of the first woman. In front and somewhat above her a vertical column reads:  "The royal acquaintance, *Nfrt-h3-Hwfw*" (1).

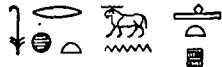
THE LEFT-DOOR JAMB OF THE RECESS (Fig. 10, Pl. XIII-B)

A composition similar to that of the right door-jamb covers the vertical panel. It represents the deceased, standing facing the axis of the door, accompanied by the smaller figure of a boy. The deceased wears a long wig and a short beard, and is dressed in a short kilt and a leopard skin, hung over his left shoulder. His left arm is bent and the hand grasps a staff raised above the ground and drawn along the frontal axis of the figure; the same hand, apparently holds the end of the knot which is tied on the left shoulder. On the left wrist is a band or bracelet. The right arm is hanging along the side. Its hand grasping horizontally a *shm*-sceptre, which is partly hidden behind the body, according to an erroneous convention common in Egyptian drawing. A necklace hangs around the neck. The horizontal line of hieroglyphs above the figure reads:  "The royal acquaintance, *Ni'-htp-hnmw*".

A very small figure of a naked boy stands on a higher line than the ground level, facing the left leg of the deceased. His right arm is bent over his breast, the hand grasping the left shoulder, while his left arm hangs loosely by his side. The hieroglyphs above him give his name:  *Prj-hr-nfrt* (2).

THE DRUM

The name of the deceased and one of his titles are inscribed from right to left:

 "The royal acquaintance, *Ni'-htp-hnmw*".


THE BACK PANEL OF THE DOOR (Fig. 10, Pl. XIV)

The figure of the deceased is again represented standing facing to the right, in an attitude similar to that shown on the left door-jamb. His wig, however, is of the short graded type and he is dressed in a short kilt. The left arm, bent over the breast, holds a long staff raised above the ground and placed vertically along the frontal axis of the figure, a peculiarity already

(1) RANKE, H., *op. cit.*, p. 197.

(2) RANKE, H., *op. cit.*, p. 134.

noticed on the left door-jamb representation. The same attitude is shown on the slab surmounting the entrance-door of the rock-cut tomb of *Nj-wd3-ptḥ* and could be an archaic feature⁽¹⁾. The right arm is hanging by the side and holds the *shm*-sceptre which is represented as held in its entirety in front of the body and crossing the vertical staff at right angles. Bracelets or wrist-bands adorn both hands. The horizontal line reads:

←  "The inspector of *w'b*-priests, *Ni-ḥtp-ḥnmw*" (Fig. 10, Pl. XIV).

In the corridor and in the northern part of it, we found three pieces of limestone, Nos. 1 and 2 (a lintel and a drum), belonging to *Ni-ḥtp-ḥnmw*; they were naturally fixed in one of the false-doors recessed in the brick wall; whilst No. 3 is a drum of *ḥntj* (Pl. XV-C):—

No. 1 (1·27 × 0·10 metres):

A lintel with one line of hieroglyphs, running from right to left (Fig. 13, Pl. XV-B):

← 

"May the King be favourable and grant, may Anubis the foremost of the divine booth, be favourable and grant, a burial in the western cemetery as possessor of honour, the inspector of the *w'b*-priests: *Ni-ḥtp-ḥnmw*".

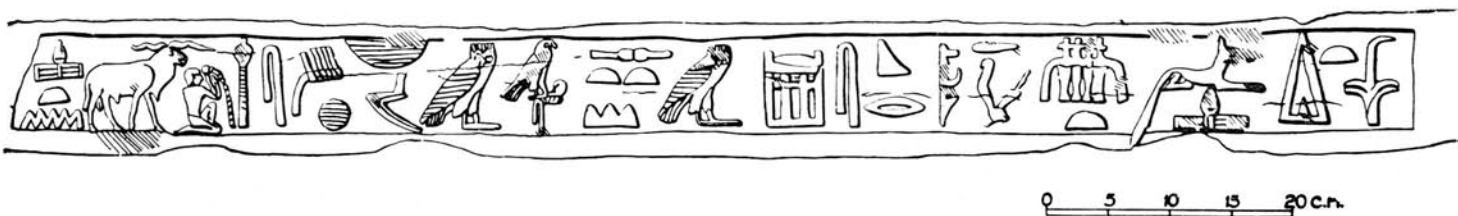


FIG. 13

No. 2 (0·86 × 0·55 metre):

A drum inscribed with the name of *Ni-ḥtp-ḥnmw*. (Fig. 14, Pl. XV-C) ← 

"The royal acquaintance, *Ni-ḥtp-ḥnmw*".

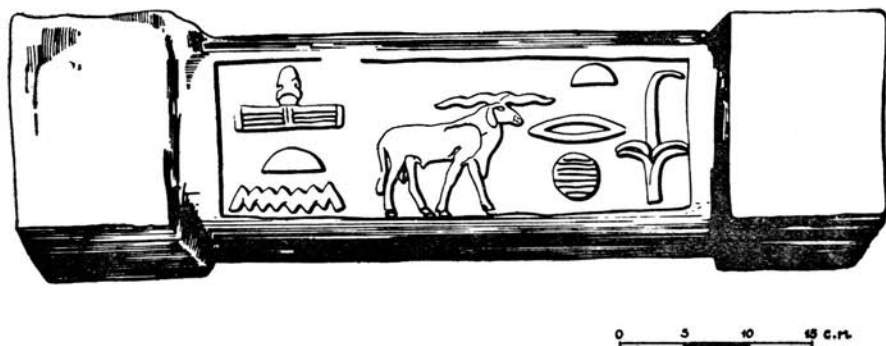


FIG. 14

⁽¹⁾ cf. Rock-cut-tomb *Nj-wd3-ptḥ*. Also SMITH, W. S., "A History of Egyptian Sculpture and Painting in the Old Kingdom", 1946, pp. 277-8, Fig. 113.



Fig. 16

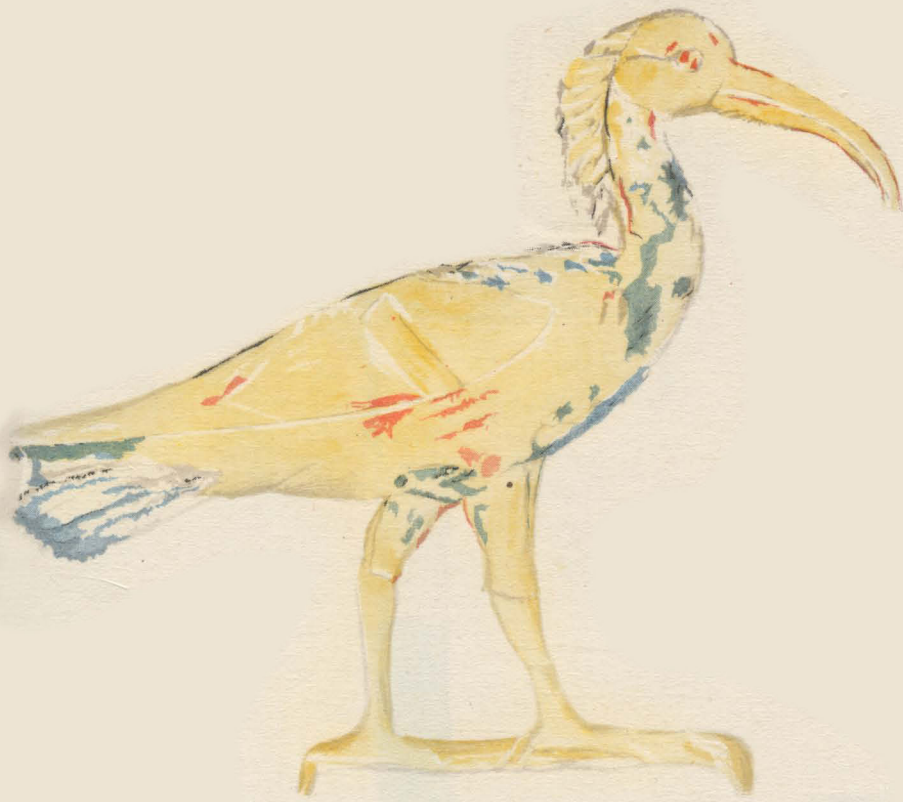





Fig. 17





Fig. 18

 The body is coloured black, the mane was blue and the horns yellow(?)⁽¹⁾. Details of the floes in the mane are outlined in black, while the head is also black. Brown lines seem to have formed part of the design in the front part of the animal. This example has much elegance in its proportions (Fig. 17).

 Most of the colouring of this beautifully drawn sign has disappeared. The body was blue, with details in black lines, and green wings. The sculpture shows the band securing the folded wings. Traces of red-brown show on the outline and on the body, black lines on the crest and tail⁽²⁾ (Fig. 17).

 The colouring of this beautiful sign is still intact, showing a yellow body with red brown markings on it as well as on the wings, tail and legs, and the outline⁽³⁾ (Fig. 17).

 The upper part is as usual with red horizontal lines on yellow background. The lower shows four rectangles separated by horizontal stripes, a plain green one between two green ones with black dots. Every rectangle is divided diagonally into two triangles, green and black⁽⁴⁾ (Fig. 18).

 Two chests, with interesting decorative features. One is decorated with three rows of isiac loops in red outline on a yellow ground, separated by undulating lines in black on yellow ground (Fig. 18).

The other one shows rather irregular parallel undulating lines in black on yellow ground. A black strip frames the whole face.

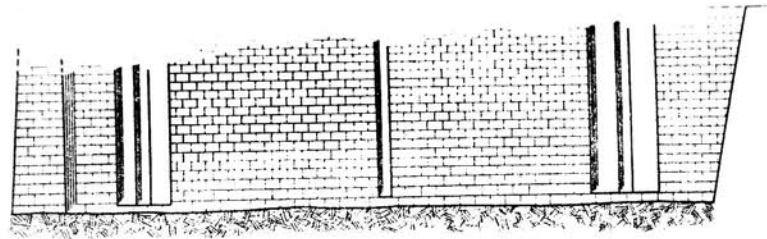
(1) SMITH, W., *op. cit.*, p. 376.

(2) SMITH, W., *op. cit.*, p. 377, Pl. B.

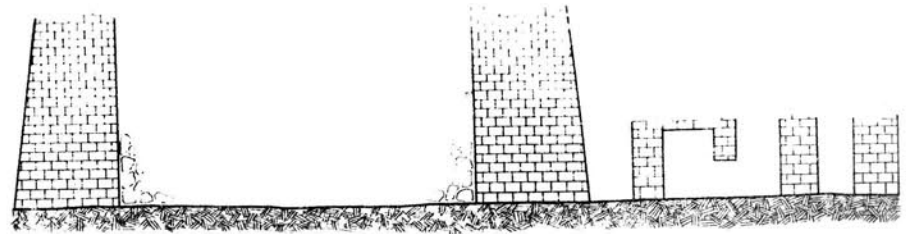
(3) SMITH, W., *op. cit.*, p. 377, Pl. A-B.

(4) SMITH, W., *op. cit.*, Pl. B, p. 380.

[This page is intentionally blank.]

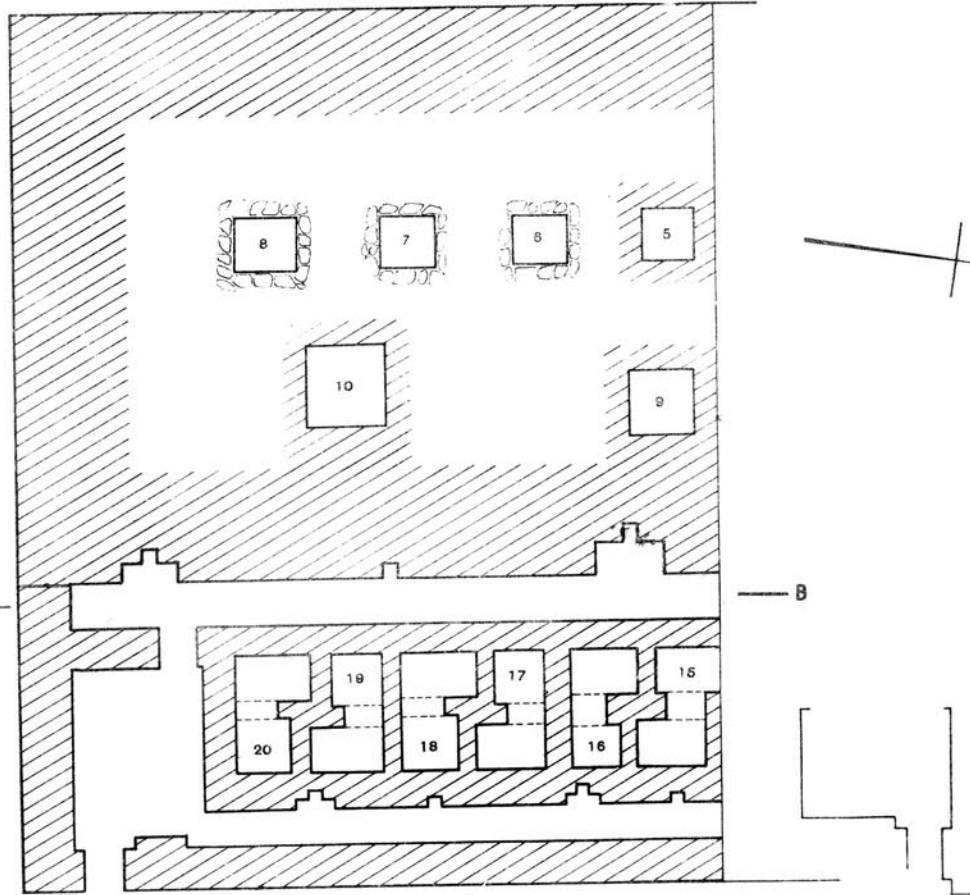


Section A B



Section C D




C



MASTABA A



REFERENCE

-  Mud Brick
-  Natural Rock
-  Gravel

Fawzy Ibrahim

FIG. 19

UNINSCRIBED MASTABA "A", SOUTH OF MASTABA OF NI-ḤTP-ḤNMW

DESCRIPTION

It is an uninscribed mastaba of crude brick built with the eastern and western faces flush with the corresponding ones of the Mastaba of *Ni-Ḥtp-Ḥnmw*; its northern side abuts upon the southern end of the latter. Adjoining its southern face is a limestone mastaba not yet excavated, while on its western face lies the Mastaba of *Ḥtj-Ḥtpw* (see General Plan).

From the different connexions of the masonry of this mastaba with that of *Ni-Ḥtp-Ḥnmw* and of *Ḥtj-Ḥtpw* and of the unexcavated stone mastaba, one may assume the following sequence as to the order of their construction:—

- (a) *Ni-Ḥtp-Ḥnmw*.
- (b) Uninscribed Mastaba "A".
- (c) *Ḥtj-Ḥtpw*.
- (d) Unexcavated stone mastaba.

This mastaba is likewise constructed of a core of nummulitic rubble stones encased by crude brick walls on a rectangular plan ($11.50 \times 13.50 \times$ height about 3.75 metres) (Fig. 19, Pl. XVI).

On the eastern face there are three recesses in the form of false-doors, one at each end with recessed jambs, the third in the middle having jambs flush with the face of the wall.

The core is similar to that of *Ni-Ḥtp-Ḥnmw*. The brickwork consists of alternating courses of headers and stretchers, the dimensions of the bricks are $40 \times 20 \times$ height 15 cms. The bricks are dark grey with a mortar of a much lighter colour, containing a high proportion of sand. The joints vary between 0.50 cm. and 2.50 cms.

There are no traces of the plastering with which the walls must have been covered.

SHAFTS

Shaft No. 5 (Fig. 20) : Dimensions : $1.10 \times 1.10 \times$ depth 3.50 metres.

,,	6 (Fig. 20) :	,,	: $1.10 \times 1.10 \times$,,	3.85	,,
,,	7 (Fig. 20) :	,,	: $1.00 \times 1.20 \times$,,	3.50	,,
,,	8 (Fig. 20) :	,,	: $1.15 \times 1.15 \times$,,	3.25	,,
,,	9 (Fig. 21) :	,,	: $1.30 \times 1.30 \times$,,	6.90	,,
,,	10 (Fig. 21) :	,,	: $1.50 \times 1.60 \times$,,	13.20	,,

All these shafts were either unfinished or empty. No traces of burials were found in the burial-chambers.

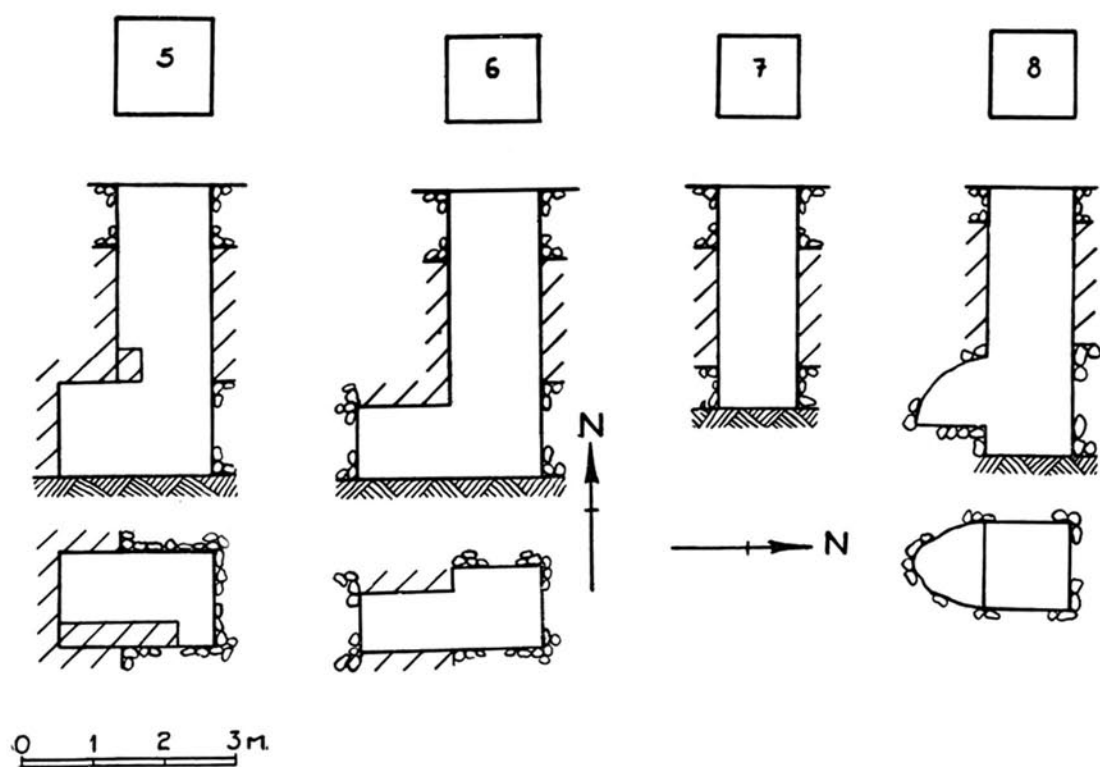


FIG. 20

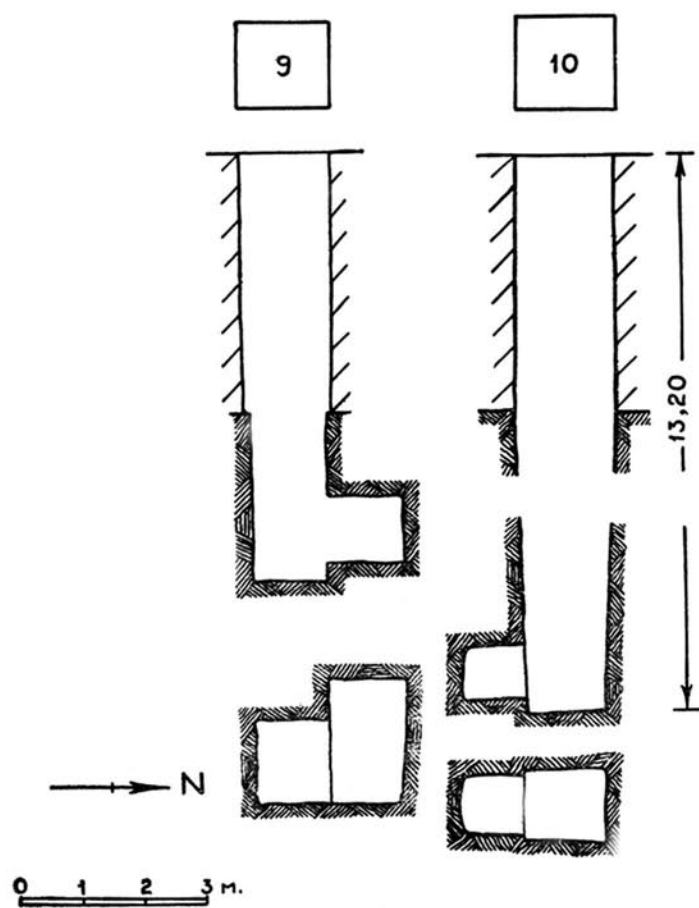


FIG. 21

Adjoining Mastaba "A" and to the east of it, there extends a complex consisting of an enclosure wall, of which two sides, eastern and southern, are built flush with the corresponding eastern face of the chapel enclosure of *Ni'-htp-hnmw* and with the southern face of the above-mentioned Mastaba "A" respectively ($5.50 \times 13.50 \times$ height about 2.00 metres). Inside this enclosure a crude brick structure is flanked by a corridor on its eastern side. At its southern end is a small entrance vestibule (0.80×1.00 metres) connected with this corridor, with the corridor of Mastaba "A" and with the exterior (Fig. 19, Pl. XVI).

The eastern face of this structure has four recesses, two with recessed jambs and false-doors, alternating with two simple ones.

This structure contains six openings, every one is double and occupies the whole breadth of the structure, both parts being connected by an arched door at the bottom of a partition wall. In each case, one of the openings is in the form of a shaft, the other to which it leads, is a small vaulted room containing a burial (Figs. 22, 23, Pl. XVII). It is most interesting to notice that the disposition of the mouths of the shafts alternate in plan with the vaulted burial-chambers.

SHAFTS

<i>Shaft No. 15</i>	(Fig. 22)	:	Dimensions :	1.00	\times	1.00	\times	depth	1.90	metres.
„	16	(Fig. 22)	:	„	:	1.00	\times	1.00	\times	„ 2.10 „
„	17	(Fig. 22)	:	„	:	1.00	\times	1.00	\times	„ 2.05 „
„	18	(Fig. 22)	:	„	:	0.90	\times	0.90	\times	„ 2.10 „
„	19	(Fig. 22)	:	„	:	0.90	\times	0.90	\times	„ 2.20 „
„	20	(Fig. 23)	:	„	:	0.90	\times	0.90	\times	„ 2.10 „

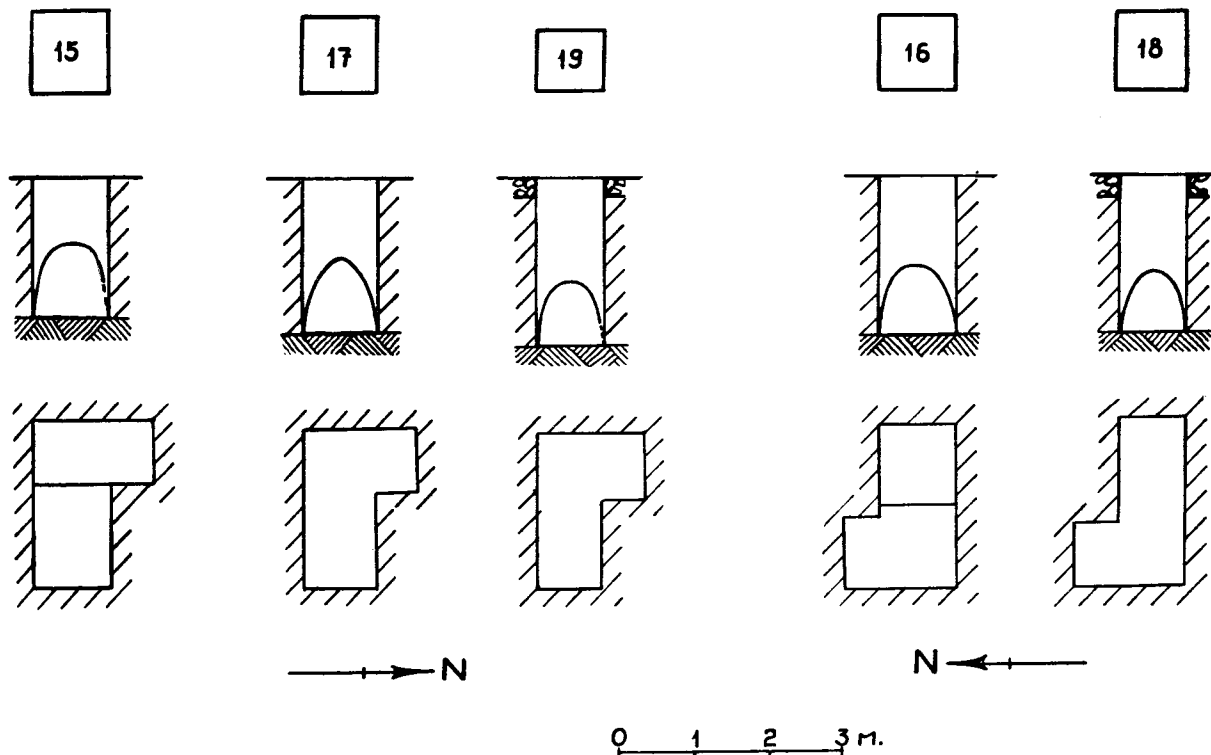


FIG. 22

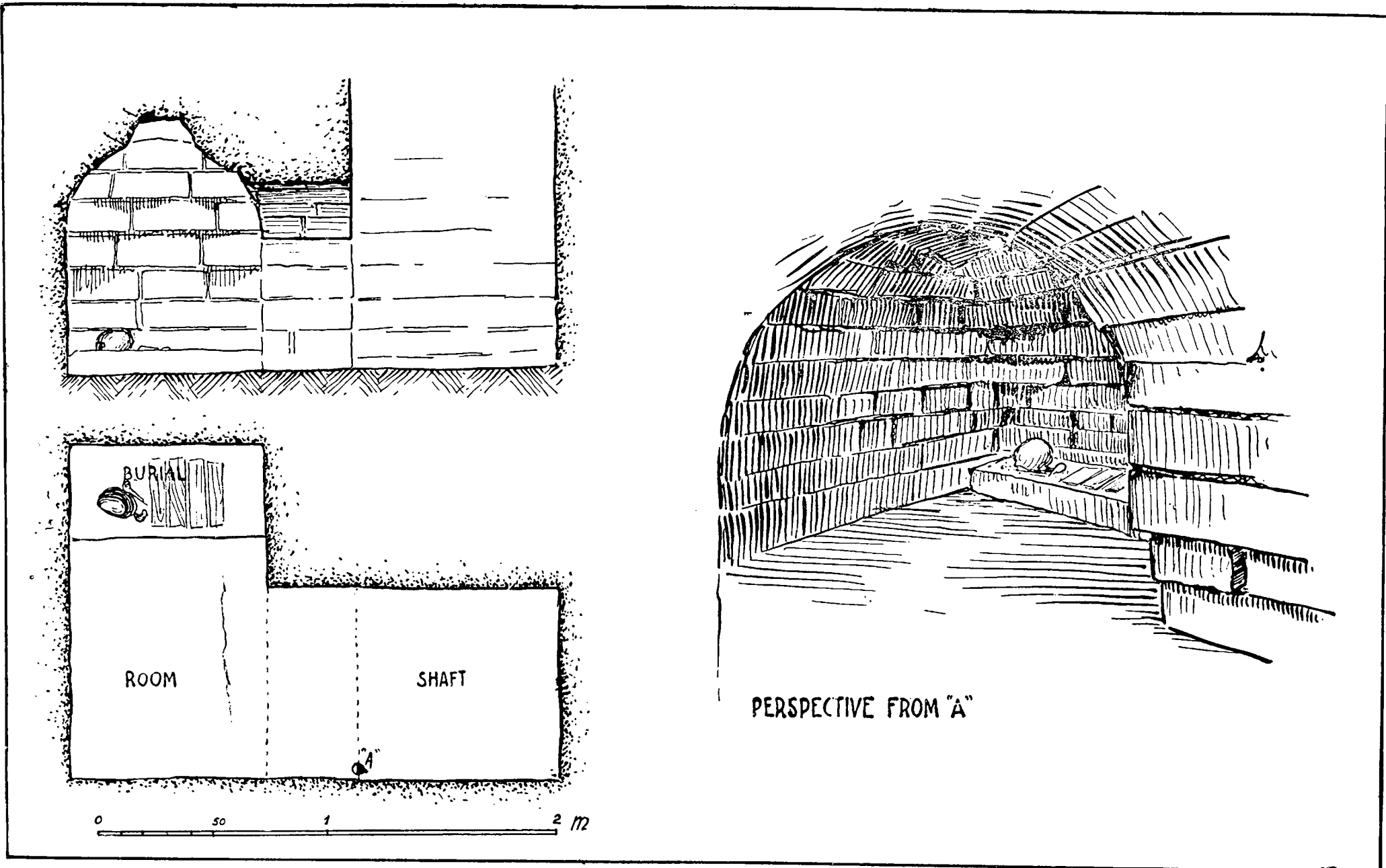






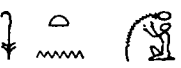




FIG. 23

MASTABA OF NFR-İHİİ⁽¹⁾

TITLES

1.  "Royal acquaintance".
2.  "Possessor of Honour with the Great God".
3.  "Possessor of Honour with the God".

TITLES OF *Sp-n*

1.  "Royal acquaintance".
2.  "King's purificator".
3.  "The *w'b*-priest of the King's Sons".
4.  "Governor of *Ht-Hufw*".
5.  "Leader of Leaders of the Great House".
6.  "Overseer of the Houses of the Royal Children".

DESCRIPTION

This is a corridor mastaba in brick, inserted (*see* General Plan) behind the Mastaba of *Nfri* and that of *ıbdw*, which lies on its eastern side. To the west of it is the Mastaba of *Ni-htp-hnmw*. The corridor opens at its northern end into a doorway flush with the northern face of the mastaba.

The main entrance, however, seems to have been at its southern end, through a door opening in the axis of the east-western passage between the Mastaba of *Nfri* and that of *ıbdw*. The quadrangular space enclosed by these later ones and the Mastaba of *Nfr-ıhiı* and an unexcavated stone mastaba to the south was used to afford a corridor, leading to the passage between the Mastaba of *Nfri* and that of *ıbdw*, and to a room between the above-mentioned door and the north-south corridor running along the eastern façade of the Mastaba of *Nfr-ıhiı*. This room, which retains part of its vaulted ceiling, was used as a chapel (Pl. XVIII-*A*), although it does not open in front of any false-door. This unusual plan, which reminds one of the IVth dynasty type of chapel, dating from the reign of Kheops⁽²⁾, is only a result of the irregular setting of the superstructure in the middle of an already built-up site.

(1) RANKE, H., "Personennamen", p. 195, 12.

(2) *cf.* JUNKEB, H., "Giza", I, p. 17.

The superstructure ($26.65 \times 12.00 \times$ height 3.00 metres) is of the usual type, walls of crude brick inclined according to a rectangular plan, and retaining a coarse rubble filling (Fig. 24). The dimensions of the chapel are $3.65 \times 1.80 \times$ height about 3.00 metres.

The corridor runs north-south along the eastern face of the superstructure. Its eastern wall is the western face of the Mastaba of *Njri*, continued southwards by a crude brick wall, less inclined than the mastaba face and abutting on its south-western corner. In the eastern face of the superstructure there are eight recesses for false-doors. Only one, the third from the southern end, has retained a limestone lintel and drum, set in the masonry upon crude brick jambs (Figs. 27, 28, Pl. XVIII-B).

Four shafts were cut in a row behind the eastern face. The first from the north seems to be connected in plan with the third recess from the north, and the second with the fifth and sixth recesses, while each of the remaining two shafts is connected with one recess, the seventh and eighth respectively. The shafts are square in plan and have side-wall in crude brick, built upon the rock-hewn sides of the pits themselves. All the shafts are found empty without any traces of burial and I give for each only the measurements (Fig. 25).

SHAFTS

Shaft No. 23: Dimensions: $1.20 \times 1.20 \times$ depth 7.25 metres; burial-chamber 0.90×1.00 metre.

„ 24: „ : $1.10 \times 1.10 \times$ „ 13.50 „ „ 1.10×2.10 metres.

„ 25: „ : $1.20 \times 1.10 \times$ „ 13.70 „ „ 1.80×0.90 „

„ 26: „ : $0.90 \times 1.20 \times$ „ 12.75 „ „ 0.90×1.20 „

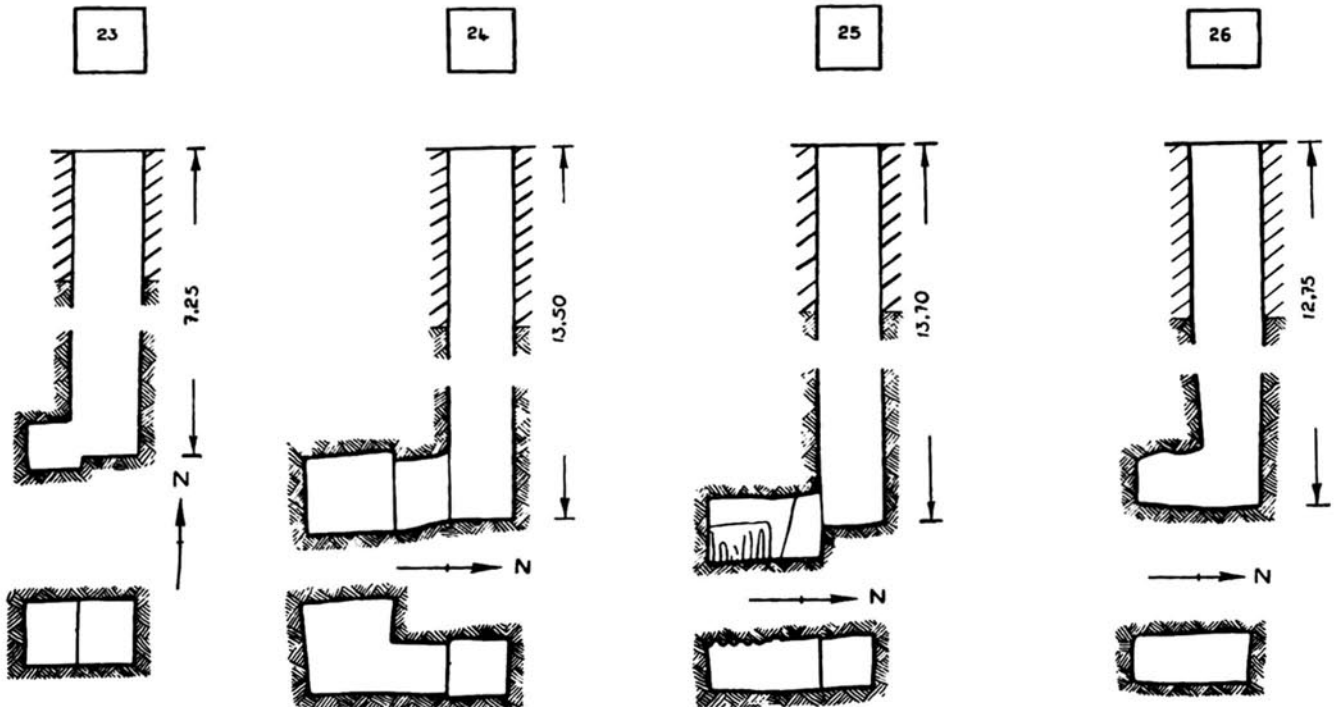


FIG. 25

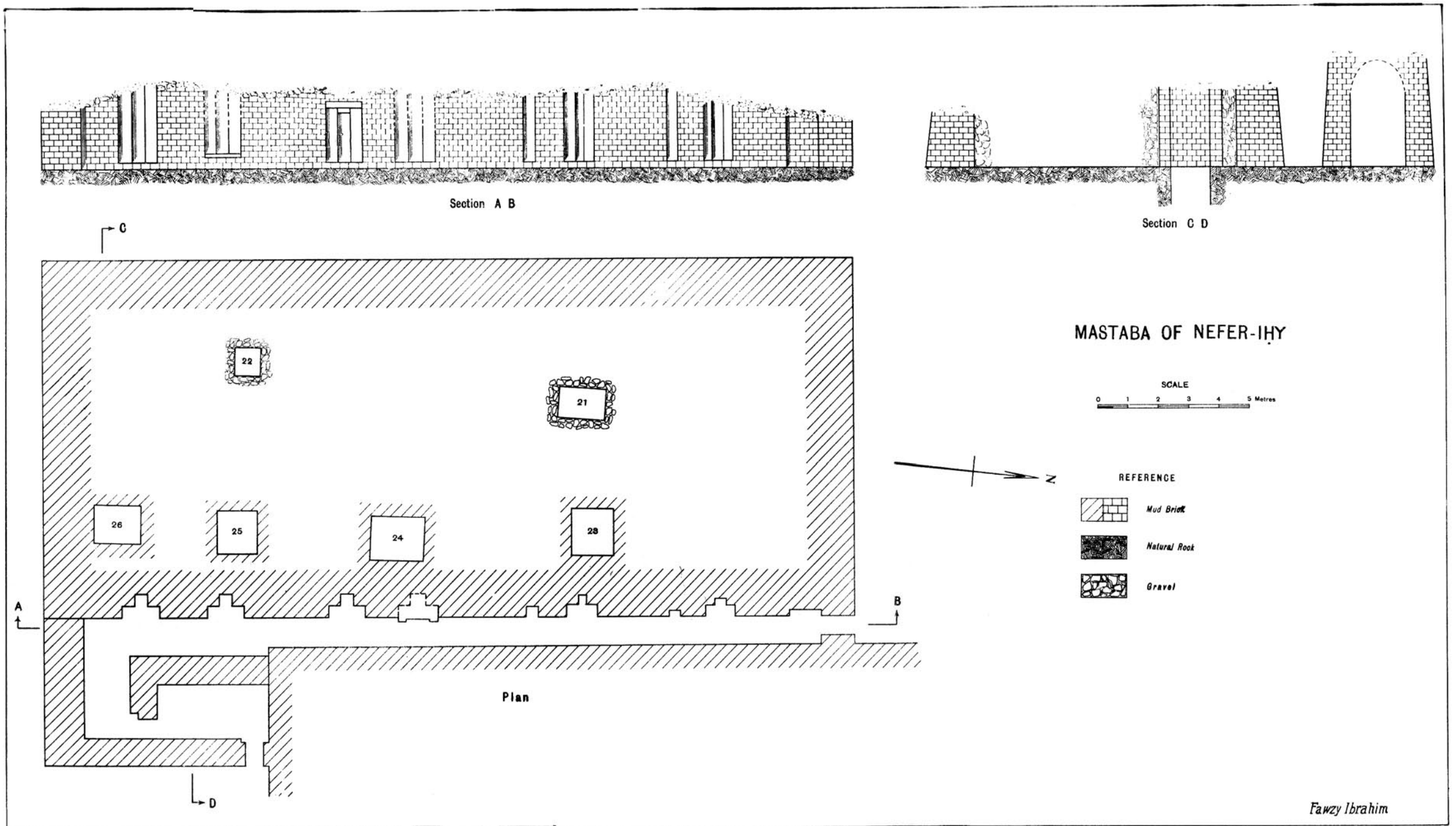
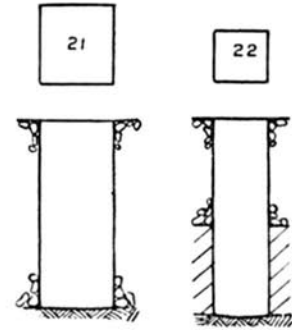


FIG. 24

Moreover, there are two unfinished shafts dug in the western side of the mastaba and marked on the General Plan with Shafts Nos. 21 and 22 (Fig. 26):—

Shaft No. 21: Dimensions 1·30 × 1·50 × depth 3·50 metres.

„ 22: „ 0·90 × 1·10 × „ 3·50 „





0 1 2 3 m.
FIG. 26

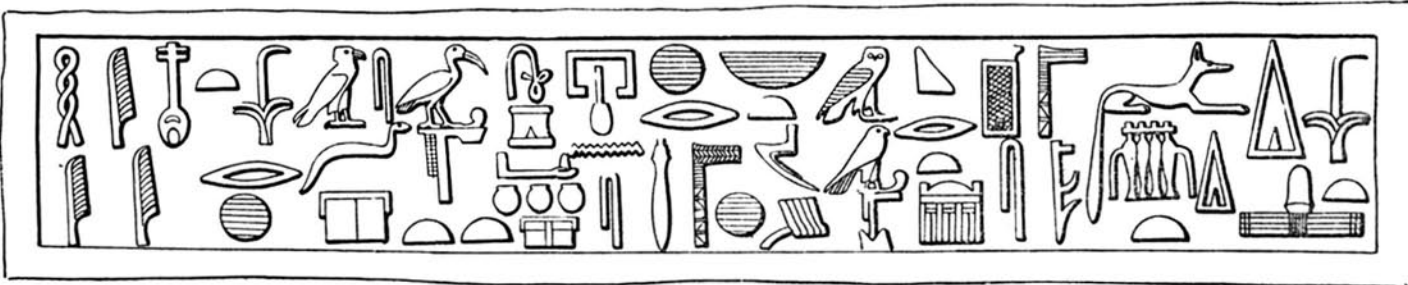
INSCRIPTIONS ON LINTEL AND DRUM

This lintel and its drum were built in the third false-door from the southern end and both are inscribed as follows:—

The Lintel (running from right to left) (Fig. 27, Pl. XVIII-B):





 “May the king be favourable and give, may Anubis, who is in front of the divine booth, be favourable and give a burial in the west (to) the possessor of honour with the great god and that it may be offered to her (at) the *W3g*-festival, the *Dhwtj*-festival, and the *š3d*-festival, namely the royal acquaintance, *Nfr-İhīi*”.



0 1 2 3 4 5 6 7 8 9 10 11 12 13 14 15 16 17 18 19 20 21 22 23 24 25 26 27 28 29 30 31 32 33 34 35 36 37 38 39 40 41 42 43 44 45 46 47 48 49 50 51 52 53 54 55 56 57 58 59 60 61 62 63 64 65 66 67 68 69 70 71 72 73 74 75 76 77 78 79 80 81 82 83 84 85 86 87 88 89 90 91 92 93 94 95 96 97 98 99 100 c.p.

FIG. 27

She wears a broad flat wig, parted in the middle; below it and above the brow, the natural hair shows. The eyes are large, and flush with the cheeks. The chin is pointed and protruding. The features resemble those of the upright statue, but the lines of the lower lids and of the mouth curve downwards, indicating a tired attitude. The face is irregularly modelled. Arm and leg, ringlets and a necklace are rendered in paint only.

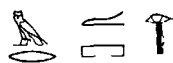
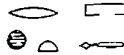





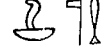







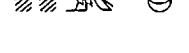
On either side of the cubic chair, on the front face and continuing on the base, the same column of incised hieroglyphs is repeated: \downarrow  \uparrow Q X Q Q "The royal acquaintance, Nfr-ihii" (Pl. XXII-A, B).

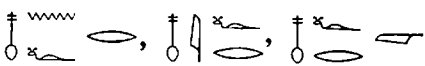

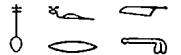



<i>Dimensions</i>	{	Height with base 46.5 cms.
		Base 24 × 24 × 6 cms.
		Width across breast 18 cms.
		Height of chair 35.5 cms.

[This page is intentionally blank.]

MASTABA OF NFRĪ⁽¹⁾

TITLES ⁽²⁾

1.  "Director of the Mercenary Guard".
2.  "The Overseer of the Property of the Palace".
3.  "King's purificator".
4.  "King's purificator of the Pyramid
3ht-Hwfw".
5.  "The One who sees the King (?)".
6.  "Royal Acquaintance".
7.  "Possessor of Honour with the God".
8.  "Priest of the Goddess *Wadjit*".
9.  "Regent of the Castle".
10.  "Regent of the Great Castle".
11.  "Commander of a Company".
12.  "Commander of a Company of Recruits".
13.  "Judge and Chief of Police (?)".
14.  "Inspector of the (Royal) Boat".
15.  "Inspector of the Great Palace".
16.  "Overseer of the (Snake-Play)".

⁽¹⁾ This name appeared in the inscriptions of this mastaba in different variations :  (to be noted the early use of the sign  written vertically),  (the writing of the name with  is very strange and apparently without parallel from the Old Kingdom. In *W.B.* II, p. 261,   "der Phallus eines Gottes", is mentioned but only from the New Kingdom and later").

⁽²⁾ For all references to the titles of *Nfrī* and their explanations, see p. 46 ff.

DESCRIPTION

The Mastaba of Nfrí has a superstructure of crude brick in a fairly good state of preservation. It has a long corridor running along the whole length of the eastern façade, and contains a deep niche with a false-door in white limestone at its southern end, and three other false-doors built in brick (*see* General Plan). A complex of three small rooms-vestibule, open court and magazine, projects from the rectangular plan at the southern end of the eastern façade, abutting on the wall in front of the doorway to the recess and giving access to this (Fig. 32-*A, B*, Pl. XXIII).

THE MASTABA

According to the elaborate classification of Reisner, the mastaba would be of the core type No. VI, *e* ⁽¹⁾. The construction of the superstructure consists of a composite rubble core encased on all four faces by retaining walls of crude brick (Fig. 32-*A, B*). The actual mastaba seems to be the result of a second stage of building plan; for the wall of the corridor chapel has been built against another eastern façade complete with a recess for the original niche of the chapel and two other smaller niches; the whole having been already plastered on its entire length with white stucco which still shows even on the southern face.

The rubble core is of dry nummulitic blocks and is of a rectangular plan. A cavity in its southern end is walled with rubble masonry and seems to be connected with a walled brick doorway on the inside of the casing of the southern face. The southern corner of the eastern part of the core is occupied by a rectangular recess of brickwork containing the earlier niche for the false-door. Here again a white stucco plastering indicates the earlier plan ⁽²⁾. It is clear that this part of the first stage of the plan contained a false-door. After the brick wall, built in this recess, had been cleared, a wooden false-door with double jambs was brought to light (Figs. 33, 41-*A, B*; Pls. XXIV, XXV, XXV *bis*, XXXIV, XXXV).

It is not deeply recessed, unlike the later limestone false-door. The door was in a very bad condition; only the lintel, the back panel of the inner recess, and the lower parts of the jambs were rescued. The whole was encased of mass in a brickwork. At the later stage of the building, a brick wall with a narrow arched doorway, connected slanting with a wall, was erected in front of the recess.

The Shaft No. 28, adjoining the first false-door recess on its northern side, could not possibly have been devised to be used in the first stage of the plan, because it lies directly behind the eastern facing wall. Had a shaft been excavated for this first stage, its position should have been behind the wooden false-door recess. Instead, we found at this part of the mastaba a cavity in the rubble core, opening to the southern face by means of a doorway walled later on with brick. This cavity was found full of debris. It is probable that this cavity represents the earliest stage preparatory to the sinking of the shaft in the axis of the original false-door. No lining, however, was found, but the rubble masonry is clearly built as a wall, and the vaulted doorway

⁽¹⁾ REISNER, " *A History of the Gizeh Necropolis, 1942* ", p. 49, Figs. 12-13.

⁽²⁾ Such additions on the eastern face are common, *cf.* G. 1406, REISNER, Fig. 167, p. 275. Very often other faces were also concealed behind subsequent casings, *cf.* FISHER, p. 82 (G. 3008).

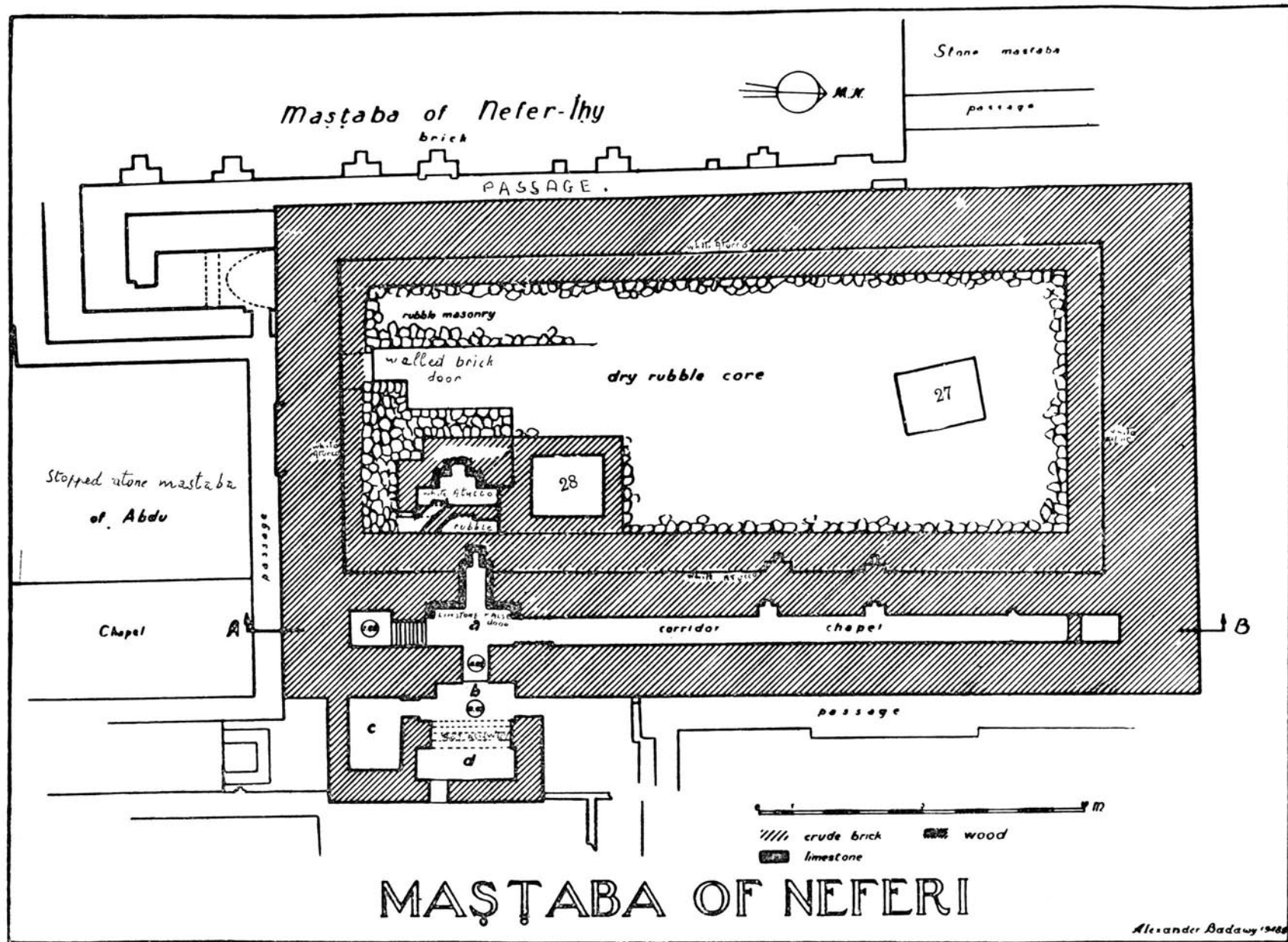
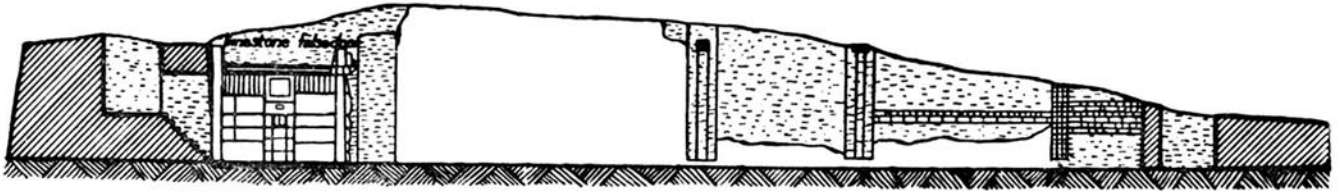


FIG. 32-A



Section A-B

-  limestone
-  mud plastering on crude brick wall
-  white stucco

0 2 4 6 m.

Yousef Shouky

FIG. 32-B

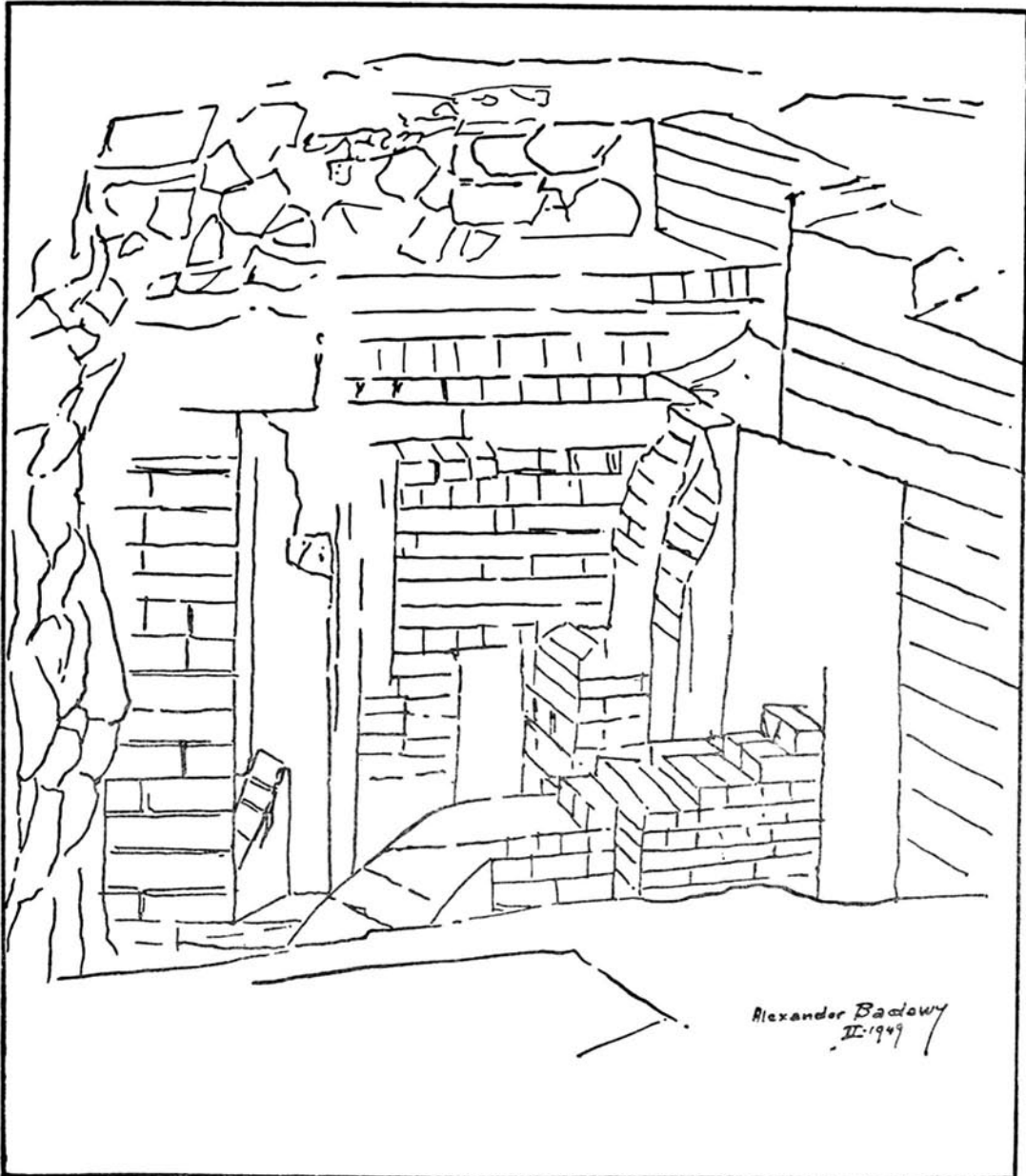


FIG. 33

could then be supposed to have been an entrance for the workmen who would have sunk the shaft and built its brick lining. As this project was not carried out, the doorway was walled up with bricks and the cavity was filled in with debris (Pl. XXVI).

Dimensions, though medium-sized in plan, are rather imposing. According to Reisner's tabulation of data, this one would give the following:

N.S.	E.W.	Prop.	Area
28	$15\cdot30$ — $15\cdot80$ $\underbrace{\hspace{2cm}}$ $15\cdot55$	1/1·8	435·40

These dimensions include the corridor chapel on the eastern façade, since it integrates into the rectangular plan, but does not include the projecting annexes. The faces are battered according to slightly different angles. The eastern façade gives an angle of $82\frac{1}{2}^\circ$, the west 80° , and the south $75\frac{2}{3}^\circ$ (1). This last façade presents in its middle a slightly projecting bulk of masonry of about 2 metres wide, independent of the general thickness of the wall in which it is embedded.

THE CHAPEL (2)

The offering-room: (a), (Pl. XXIX-A) is of the corridor chapel type, featuring a corridor about 80 cms. wide running along the whole eastern façade and connected with an open court, (b) by a doorway in the axis of the deep recess of the niche.

The corridor has battered walls, $78\frac{1}{2}$ for the eastern face and $85\frac{3}{4}$ for the western, plastered with mud and yellow-white gypsum, and then whitewashed. The covering seems to have been a vault, the remaining traces of the springing of the curve and bricks, found fallen in situ inside the corridor, were of the special mould with two half roundings along one of the longer sides. The vault was very probably of the ribbed type, known from the archway in the annex of the same mastaba and other examples (3) (see Chapter on Vaults, p. 129). Three niches are recessed in the brickwork of the eastern wall of the corridor, and have drums, but no figures or inscriptions. The northern end of the corridor has been blocked with a transversal wall leaving behind a small recess, perhaps intended to be used as a magazine.

At its southern end the corridor widens into an offering-room presenting on its western face the two battered limestone jambs of the niche. A deep recess in its middle encases the false-door. This part of the offering-chamber displays on its white walls (4) a plinth topped with a black string fillet. The corridor is connected at its southern end with a small quadrangular space with pavement about 95 cms. heightened by a series of graded brick courses now presenting the aspect of steps (Pl. XXVII). The connecting opening is covered with an inclined ceiling. The mud-plastering of both sides of this connecting opening shows the peculiarity of rectilinear

(1) Compare a similar variation in G. 3030, FISHER, p. 109.

(2) Compare that of HEMION G. 4000, REISNER, Fig. 121, p. 212; also FISHER, p. 2.

(3) FISHER, p. 115, G. 3033, where the corridor chapel is also a "reeded" vault.

(4) FISHER, p. 117, G. 3033, where a black border at about 90 cms. was painted over a plinth of yellowish mud mortar with white stucco.

projecting traces inclined in directions opposite to the ceiling but tending to meet towards the face opening on the corridor. One may surmise the existence of a wedge-shaped window, with a horizontal transversal slit on the corridor face, widening into a large squarish opening on the face of the small room. This was probably the *serdab* ⁽¹⁾ having a higher floor in order to bring the small funeral statue up to a level with the people offering in front of the niche, and a wedge-shaped window to allow to see and participate in the offerings. Such a procedure of bringing the level of the small statue up to the eyes of the offering people is known in a small *serdab* concealed in the wall of the offering-room and connected with the outside world by a horizontal slit ⁽²⁾. As to the wedge-shaped window, it occurs in a stela of Giza ⁽³⁾ with a horizontal slit. The wedge-shaped windows with vertical slit are more frequently common ⁽⁴⁾. The small room seems to have been covered with a cupola whose springing course left rounded pendants at the top of the walls.

The offering-room has its floor raised by a step 8 cms. high, above that of the open court, with which it communicates by a doorway opening in the axis of the niche and narrowed by an additional narrow wall set against each of the jambs. The court is narrow and partly recessed opposite the mastaba. It has a door at its northern end towards the exterior, and another at its southern end leading into a small room (c) which was used as magazine.

Opposite the recess of the court in the mastaba face, a flat archway spans an opening leading to a narrow rectangular room (d) which might have been an entrance lobby or vestibule. A small opening shows at the southern end of its eastern wall, and does not seem to have been used as a door, its sill being higher than both internal and external floors. The archway, coloured red, is of the ribbed type, two bricks thick with 4 ribs and is almost approximately in the axis of the court, door, offering-room, and niche. The vault springs from a flat string moulding above white plinth (Pl. XXVIII).

A similar arrangement, though simpler, is displayed in *Sib-f*'s corridor chapel (G. 3033), where a recess behind a flat arch is disposed in the form of the main niche, at the southern end of the corridor ⁽⁵⁾. A blocked door seems to have connected it some time with the exterior.

The walls of the offering-room, except that of the niched face of the *serdab*, magazine and lobby, are vertical. According to the scheme followed by Reisner the main date of the chapel, added to those of the mastaba, can be tabulated as follows ⁽⁶⁾ :—

Serdab	Chapel Niches	N.S. × E.W. Area	Prop.	Entrance from
1	4	21·20 × 0 80 = 16·96 metres	1/2 6·5	N.
Mastaba-Area		Pits	Serdab	
435·40		2	1	

⁽¹⁾ The *serdab* occurred at the southern end of the corridor in cruciform chapels, cf. G. 5100, REISNER : Fig. 152, pp. 248-9.

⁽²⁾ G. 3035 ; FISHER, Fig. 114 ; G. 2098, Fig. 51, p. 64.

⁽³⁾ JUNKER H., "Giza", II, p. 7, Fig. 152 (G. 5100).

⁽⁴⁾ REISNER, Fig. 153 (G. 5230), Fig. 162 (G. 2370) ; Fig. 180 (S. 4410), Fig. 189 (L.G. 53-54).

⁽⁵⁾ FISHER ; p. 115, Plan 3 ; REISNER ; Fig. 173, p. 279.

⁽⁶⁾ Compare Hmiwnw ; REISNER, "A History of the Gizeh Necropolis", I, p. 268.

SHAFTS

Shaft No. 27 (Fig. 34) :

Dimensions: $2.00 \times 1.80 \times 9.00$ metres. The upper four metres are built up in mud-bricks and the remainder are cut out in the rock itself. Both the entrance to the burial-chamber and the burial-chamber itself are unfinished. The chamber ($1.80 \times 1.35 \times 1.30$ metres) contains no traces of burial.

Shaft No. 28 (Fig. 34) :

Dimensions: $2.20 \times 1.90 \times 10.60$ metres. It is already mentioned that the main shaft of this mastaba adjoins the first wooden false-door recess on its northern side. Also the four upper metres are built of mud-bricks within the superstructure of the mastaba. The remainder part of the pit is cut out in the rock itself.

The entrance (1.10×1.20 metres) to the burial-chamber was blocked with huge mud-bricks, except a small part through which the robbers were able to reach the sarcophagus.

The floor of the burial-chamber ($3.60 \times 2.65 \times 1.90$ metres) is lower than the bottom of the pit. On its western side there is a recess ($1.80 \times 1.00 \times 0.45$ metres) which contained few scattered pieces of wood apparently all that remained of a wooden sarcophagus. There were no traces of canopic jars nor of funerary objects.

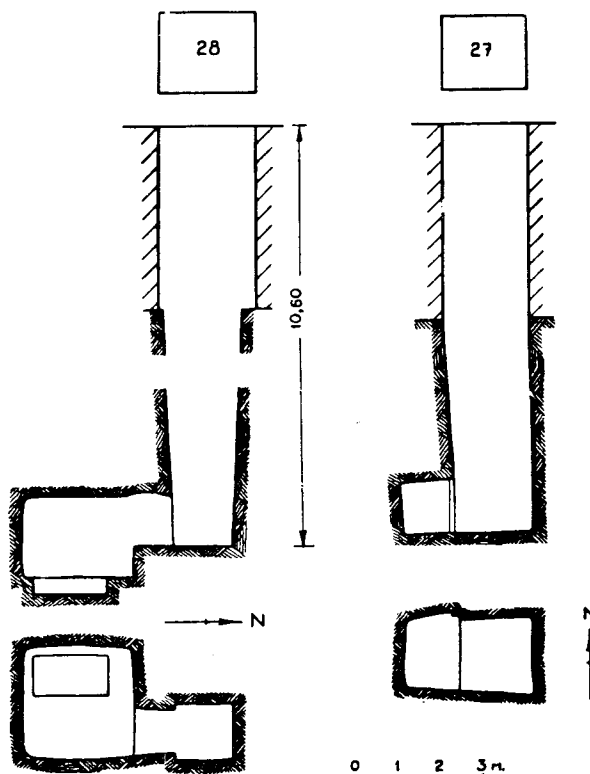


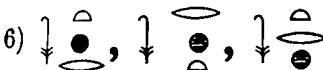


FIG. 34


MATERIALS ⁽¹⁾

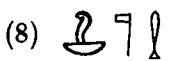






The core is of local nummulitic rubble stone. The rubble masonry employs a mortar of gypsum. Brickwork displays alternating courses of headers and stretchers, an arrangement common at that period. It is used in vertical walls in the annexes to the chapels and in the offering-room, and also as lining to the shafts. Battering walls occur internally and externally, as casing of the rubble core. The vertical joints are fine and open, while the horizontal ones are irregular, varying in width from 1 cm. to 4 cms. The bricks are dark grey, with the dimensions: $(9-10) \times 13 \times (30-31)$ cms. Special bricks are used for recessed vaults.


The mortar includes coarse sand, pottery sherds and pebbles. The external plaster is of 5-6 cms. of mud layer. This was coated with yellowish mortar 1-2 mms. thick whitewashed. In the corridor chapel the plastering is of successive coats of 2-3 cms. yellowish white gypsum, hatched straw, $\frac{3}{4}$ cm. mud, $\frac{1}{2}$ cm. yellowish white gypsum and finally whitewash. Such an unmethodical use seems to indicate that the coats were laid at different dates, perhaps during restorations or renewals.


⁽¹⁾ FISHER, *op. cit.*, pp. 14, 15.


6)  *rh-nswt*: This title is very puzzling through the different ways of writing it, and through the different translations given by scholars. It may be read  *iri-ht-nswt* "the one in charge of the things of the King (1)" or  *rh-nswt* "Royal acquaintance (2)". Junker sometimes translates this title "*Königsenkel* (3)" and sometimes "*Nachkomme* (4) *des Königs*" or "*Königsabkommeling* (5)". Selim Hassan translates it as "the one who is concerned with the affairs of the King (6)". In this book, I will stick to the translation: "Royal acquaintance".

(7)  *nb. imsh-hr ntr* "Possessor of honour with the god (7)"; Could this god "*ntr*" be the same as the great god "*ntr's*" found in parallel titles (8), or does it refer here to the King?

(8)  *hm-ntr Wsdjt* (?) "Priest of the Goddess *Wadjet*": The title is usually written  (9). Could it be a variant in which the serpent was shortened so as to make it hide partly inside the basket? In the meantime, we have to notice that this title is written on the wooden false-door (see p. 66)  and that makes us sure that both titles are identical. In the Pyramid Text 606 *a*, we find  in  "light" and the sign shows a viper lifting herself from a bowl. The viper in this case represents the flame; because in the above-mentioned Pyramid Text the dead King asks *Atum* to allow him a "light" to be kindled in order to protect him. In the Pyramid Text 247 *a*, we find  and  as identical and both represent the lower Egyptian goddess the Uraeus-snake.

(9)  *hks-ht* and sometimes read by Junker *hks-hwt* (10). The translation varies: "Regent of a castle (11)" or "*Gutshofmeister* (12)"; "*Ortsvorsteher, Dorfschulze* (13)".

(10)  *hks-ht-'s (t)* "Regent of a great castle".

(11)  *hrp-prw-ntrw* "Commander of a company of recruits (14)".

(1) PIRENNE, H., *op. cit.*, II, p. 253.

(2) *W.B.*, II, 446; PIRENNE, H., *op. cit.*, II, ref. p. 553; III, p. 625.

(3) JUNKER, H., "Giza", VIII, 16, 17, 21, 174, IX, 37, 52, 60, 67.

(4) JUNKER, H., *op. cit.*, IV, 4.

(5) JUNKER, H., *op. cit.*, IX, 157, 163, 167.

(6) S. HASSAN, "Excavations at Giza", Vol. III, p. 261.

(7) JUNKER, H., *op. cit.*, VIII, 80.

(8) JUNKER, H., *op. cit.*, VI, 198, IX, 87, 172, 228, PIRENNE, H., *op. cit.*, III, 194.

(9) JUNKER, H., *op. cit.*, V 16; *W.B.*, I, 268.


(10) JUNKER, H., *op. cit.*, VI, 17 *fol.*


(11) PIRENNE, H., *op. cit.*, II, 285-286; III, 228-229.


(12) JUNKER, H., *op. cit.*, III, 96, "*Gutsverwalter*".


(13) *W.B.*, III, 1.




(14) PIRENNE, H., *op. cit.*, II, 211; III, 83, 108, 113, 256. JUNKER, H.; *op. cit.*, V, 158-160; IX 196-197.

(12)  *hrp-pr* "Commander of a company (1)".

(13)  *s3b-hri-skr* "Judge and chief of police" (?): The title of *s3b* "judge" often precedes others with which it seems to be connected (2). Pirenne even considers it as an indication of the highest degree in the hierarchy, of the special function mentioned after it (3).

(14)  *shd-wiz*: This title, variously translated, Junker translates it "*Aufseher des Schiffes* (4)". Pirenne reads it: *shd-dpt* and translates it "Chief of the fleet, superior officer of a boat (5)". It could be also connected with the designation known elsewhere "*wiz-nswt*" meaning "royal-*wiz*-ship (6)". In this case the title may be translated: "Inspector of the (royal) boat".

(15)  *shd-pr-3* "Inspector of the palace (7)".

(16) : This title is difficult to explain. The word  may be  *mhn* (8), "Snake-play (9)". Is it possible to translate this title "[Overseer] of the Snake-play"; so long as "Overseer of Amusements *shmh-ib*" is already known.

THE LINTEL ON THE ENTRANCE FAÇADE (Fig. 35)

A single line of inscription, running from right to left, gives the short form of the offering formula in the name of Anubis: "May Anubis be favourable and give an offering at the *w3g*-festival, at the *Dhwj*-festival, at the *sd3*-festival, at the month-festival and at half-month-festival to the master of the company of recruits, Nfr (i)".



FIG. 35

(1) PIRENNE H., *op. cit.*, III, 108. (This form *hrp-pr* must be an abbreviation of the fuller one: *hrp-pr-nfrw*).

(2) JUNKER, H., *op. cit.*, III, 141.


(3) PIRENNE, H., *op. cit.*, II, 253, 357; III, 155.

(4) JUNKER, H., *op. cit.*, V, 186; VI, 239, 240.

(5) PIRENNE, H., *op. cit.*, II, 213, 222; III, 109, 112, 255.

(6) W.B., I, 272.

(7) JUNKER, H., *op. cit.*, V, 54. PIRENNE, H., *op. cit.*, II, 53; III, 36, 114.

(8) For the graphic metathesis of , cf. *Medum*, Pl. XIII; compare also JUNKER, H., "Giza, IV", p. 36.

(9) RANKE, H., "Das Aegyptische Schlangenspiel" (*Sitzungsbericht der Heidelberg. Akad. der Wissenschaften* 1920).

FAÇADE OF THE LEFT JAMB (Fig. 36, Pl. XXIX-B)


The deceased is seen walking towards the door-opening (the upper part of the body shown en face). He wears a short graded wig adorned with a hair-band knotted in a large double loop (1). The left hand holds the long staff of command and the right, adorned with a wrist band, and hanging, carries the *hrp*-sceptre. A short kilt with two pointed ends covers the two loins.

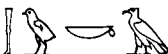


FIG. 36

(1) ERMAN-RANKE, "Aegypten and das aegyptische Leben im Altertum", Abb. 153.

Behind this figure two smaller ones in two superimposed registers seem to follow. The upper figure represents a youth, his right arm hanging, his left bent on his breast, both fists closed, the hair short; he is dressed in a short kilt and the belt has a looped knot. His name

 *Kj(j) m.iwn (?)* is written above him.

The lower figure is identical with the former but differs in the type of knot in the belt. The name is:  *Wḥmw(?)Kj(j)*.

The upper part of the rectangle is inscribed with eight columns of hieroglyphs giving the offering-formula and the titles of the deceased:—

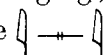
“ May Anubis the foremost of the booth be favourable and give, a burial in the necropolis as possessor of honour with the god, that he may have an offering at the *wjg*-festival, at the *Dḥwtj*-festival at ⁽¹⁾ every season of the year, on the first (day) of the month, on the first (day) of the half month, at the month-festival, (at) the *sdj*-festival, to the inspector of the court, master of the company of recruits, royal acquaintance, judge and chief of the police, regent of the great palace, Nfri. ”


FAÇADE OF THE RIGHT JAMB (Fig. 37, Pl. XXIX-C)

The deceased is represented walking towards the opening of the door—the upper part of the body shown en face, as usual in Egyptian drawings. He holds in his right hand the long staff of command and in his left the *hrp*-sceptre. Both hands are wrongly represented and should have been interchanged.

The head with short hair is adorned with a hair-band with a knot consisting of two hanging ends and two lotus-shaped ornaments. The figure wears a large necklace of several rows, on the lowest of which hang a series of pear-shaped beads.

The body is treated in a realistic way and the fat bosom and protruding belly indicate a well-nourished person, or perhaps a ripe age, although the face looks young. A similar double treatment is to be noticed in the neighbouring tomb of *ḥbdw*. Nfri is dressed in a short kilt with the usual belt ⁽²⁾ and the looped knot. Behind him two small figures follow in two superimposed registers.

The upper figure is a youth walking, his right hand bent on the breast, his left hanging; both fists are closed. He is dressed in a simple kilt, showing no ornaments. His name  *isi* is written in large hieroglyphs above his head.

The lower figure, a woman standing, is dressed in a long robe with the shoulder straps suspenders common in the Old Kingdom ⁽³⁾. She wears the large wig and is smelling a lotus-flower which she holds in the right hand, while her left arm is hanging down with the hand closed. The name is written above her head:  *nfrt-ḥj nswt*.

(1) The sign “m” is erroneously repeated.

(2) JUNKER, “Giza”, V, 1941, Abb. 13, 6.

(3) ERMAN-RANKE “Ägypten und das ägyptische Leben im Altentum”, 1923, Abb. 89.

The upper part of the jamb is inscribed with eight columns containing the offering-formula and the titles of Nfrī : —

“ May Anubis the foremost, of the divine booth be favourable and give, a burial in the necropolis, as possessor of honour with the god, that he may have an offering at the *wsg*-festival, at the *Dhwtj*-festival, at every month-festival, to the overseer of the property of the Palace, the judge and chief of the police, the regent of the great castle, the king’s purificator of the pyramid, *ihthwfw*, the director of the mercenary guards (?), Nfrī”.

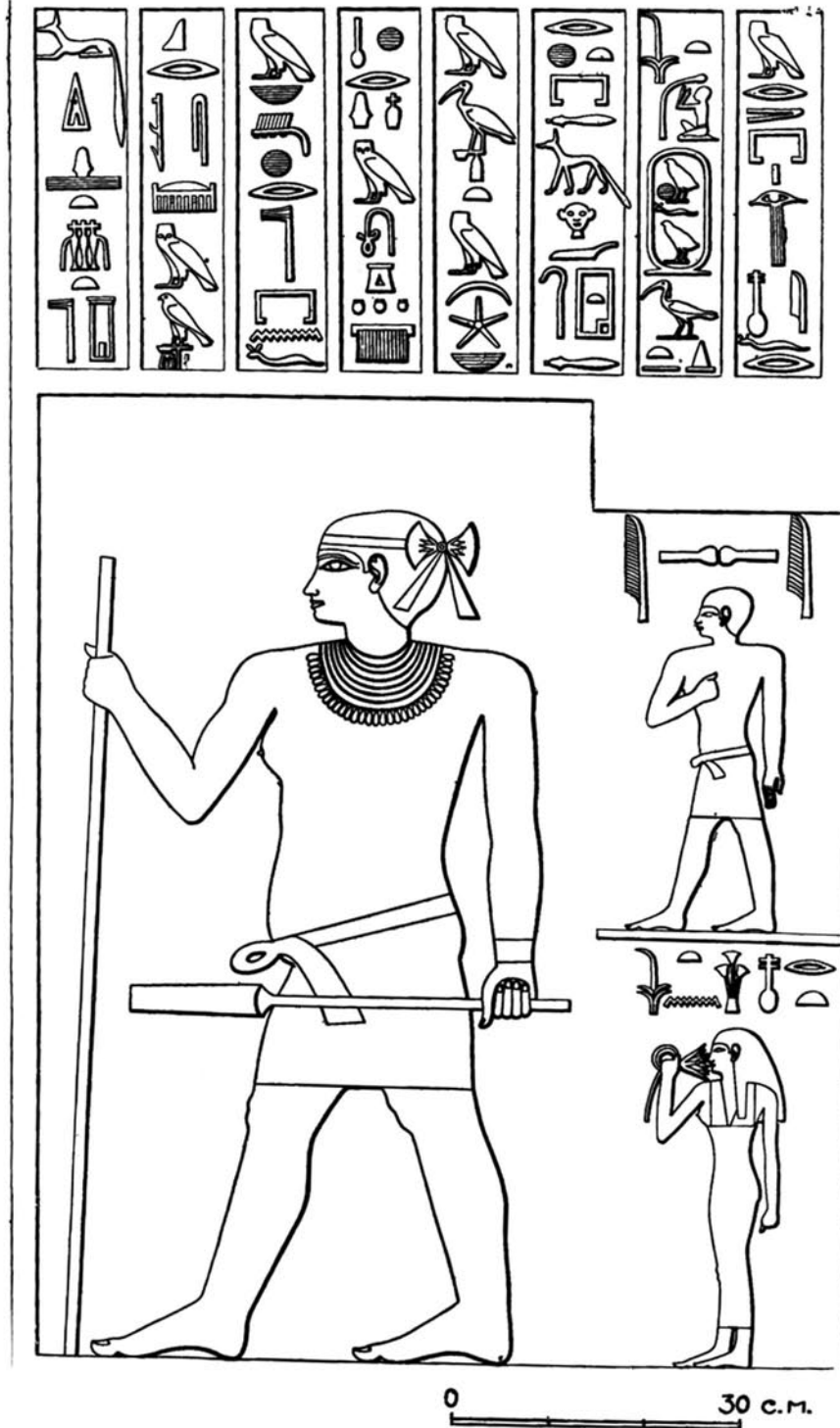



FIG. 37

SIDE OF THE LEFT WALL, OUTER RECESS IN THE FALSE-DOOR
(Fig. 38, Pls. XXX-A and XXXI)

This wall, in its whole width, is occupied by three registers topped with a horizontal line of inscriptions which gives the titles of Nfri :  "Inspector of (the royal) boat, the judge and chief of the police, the regent of the palace, the master of the company of recruits, the royal acquaintance, Nfri".

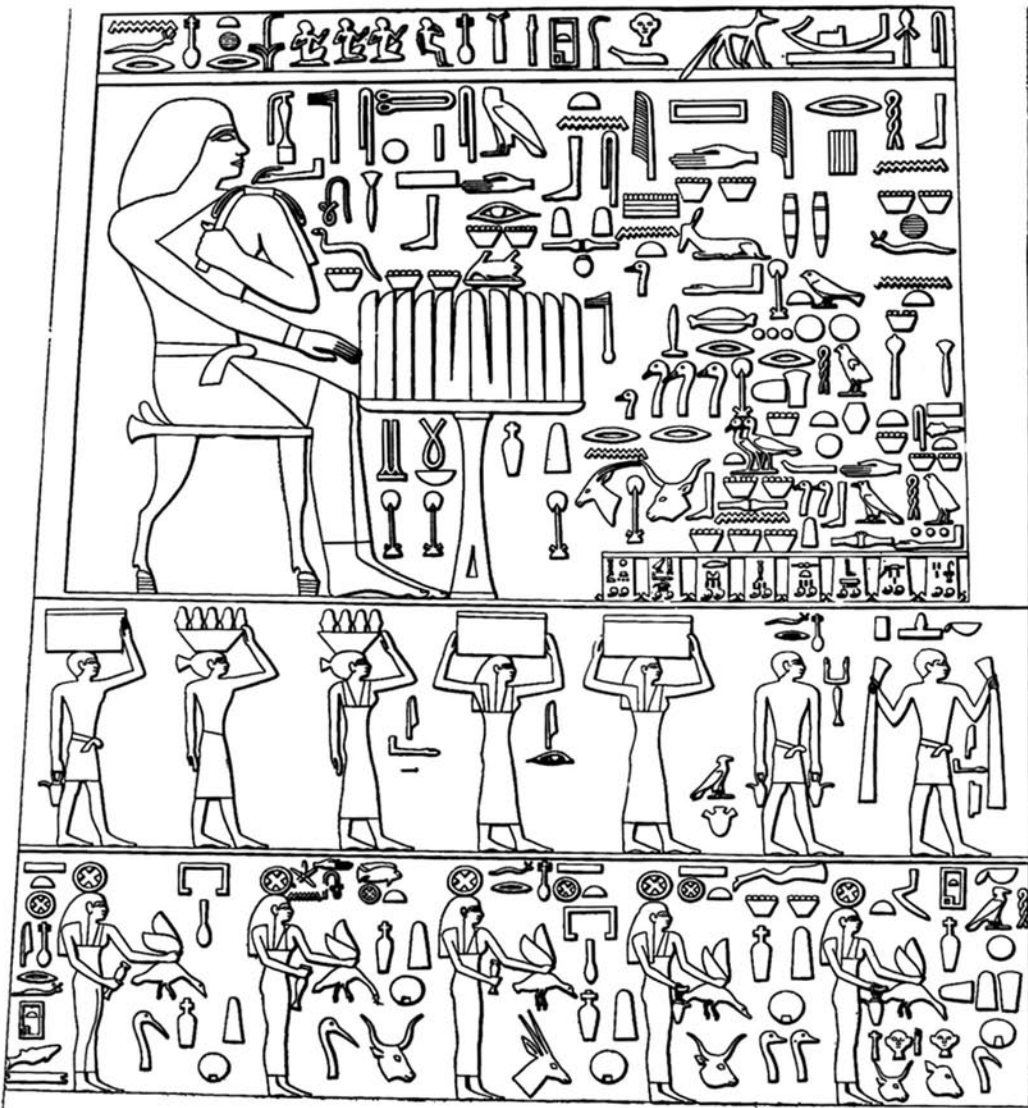



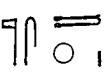
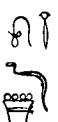
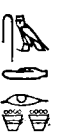



FIG. 38


0  40 c.m.



On the top register, which is higher than the two others, a scene of the funeral meal with a list of the offerings is represented. At the left end of the scene the deceased is sitting on a stool looking towards the inner part of the false-door. In front of him is an offering-table. He is dressed in a long robe fastened on the left shoulder by a knot with long ends. One end is looped over his left arm, whilst the deceased holds the other end in his left hand. The robe reaches down to the ankles.


A short kilt and a knotted belt complete his dress. He wears a large wig covering the ears and falling well behind the neck. The right hand, adorned with a wrist-band, is extended towards the tray which is placed upon a stand of the usual form with a triangular opening in its base.

The whole space in front of the deceased is inscribed with intermingled hieroglyphs, giving a series of offerings names :—

- (1)  “Cool water (for) washing (1)”.
- (2)  “Incense (2)”.
- (3)  “Green kohl, one bowl (3)”.
- (4)  “Black kohl, two bowls (4)”.
- (5)  “Meal, two bowls (?) (5)”.
- (6)  “Fruit-bread, two portions (?) (6)”.
- (7)  *s(w)nuj* “Wine from Pelusium (?) (7)”.



(1) This item, which usually begins the series of names of offerings, occurs in the same form on the false-door of *snt-its* in the Mastaba of *Snb* (JUNKER, H., “Giza”, V, 99-100; cf. also JUNKER, *op. cit.*, II, 83). The word is sometimes written with the addition of  (?).

(2) Following the oblation ceremony, the burning of incense was connected with the beginning of the meal. This item occurs always at the beginning of the list, in this form or with the addition of a flame , or an incense-burner , JUNKER, “Giza”, II, 79; III, 99, 100; IV, 24, 25, 88. B. VANDER WALLE, “*Le Mastaba de Neferintenef*”, p. 67.

(3) Forming part of the prerequisites for a funeral meal, kohl in its two varieties, green and black, occurs after the items of purification and is written with the  as determinative (JUNKER, H., “Giza”, II, 75, 83, 84, 129, 170). The bowl here can only be interpreted as such, but on analogy with other names showing two bowls, or other determinatives with a clear idea of duality, one can surmise that here also the idea of number is understood.


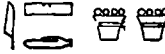



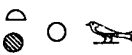

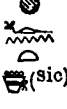


(4) Following the green kohl as elsewhere, this item is clearly numbered (JUNKER, H., *op. cit.*, I, 229, 244; II, 75, 83, 84, 129, 170; B. VANDER WALLE, *op. cit.*, p. 67).

(5) This name seems to introduce the series of edible items (JUNKER, H., *op. cit.*, II, 78, 84; III, 99, 100; IV, 25, 88) and sometime occurs in a compound: “meal times” (JUNKER, H., *op. cit.*, VIII, 104, 120). The two bowls could be interpreted as a variant for


  which occurs once (JUNKER, H., *op. cit.*, III, 100).

(6) Sometimes identified with the *jujube*-fruit (B. VANDER WALLE, *op. cit.*, p. 70) or *Nabk*-fruit (JUNKER, H., *op. cit.*, 104, 144) following L. KEIMER, “*Die gartenpflanzen*”. This fruit seems to have been prepared in a kind of paste.

(7) This item could be understood as a kind of vase (W.B., III, 427) or a sort of wine (JUNKER, H., *op. cit.*, VIII, 121, 150).

- (8)  "Natron (1)".
- (9)  "is'd-fruit, two bowls (2)".
- (10)  "Pigeon, one (3)".
- (11)  "Haunch, one thousand (4)".
- (12)  "Wine, two jugs (5)".
- (13)  "Cake, two portions (6)".
- (14)  "Hbnnwt-fruit, two bowls (7)".
- (15)  "Cake (?), one bowl (8)".
- (16)  "White kernel-fruits, one bowl (9)".
- (17)  "Green kernel-fruits, two bowls (10)".

(1) An item for purification that has been shifted here, although it is usually connected with "k̄bh̄w" or "mw" just at the beginning of the list (JUNKER H., *op. cit.*, I, 147, 244; II, 4, 84, 171; III, 99, 100, 102; B. VANDER WALLE, *op. cit.*, p. 68).

(2) The writing, sometimes determined with  is the only proof that this item is a sort of fruit (JUNKER, H., *op. cit.*, VIII, 150, also II, 83, 84, 170, "suesse Frucht", B. VANDER WALLE, *op. cit.*, p. 69).

(3) An item which occurs also among the victuals heaped on the offering-table (JUNKER, H., *op. cit.*, I, 147; II 171; III, 99, 100; VIII, 121; B. VANDER WALLE, *op. cit.*, p. 68).

(4) One of the items regularly shown in the victuals upon the offering-table (JUNKER, H., *op. cit.*, I, 147, 244; II, 4, 84, 171; III, 99, 100; IV, 25, 88; VII, 56, 80; B. VANDER WALLE, *op. cit.*, p. 68).

(5) JUNKER, H., *op. cit.*, VIII, 105, 150 enumerates the different kinds; see also I, 176, 229, 244; II, 171 and III; IV; V volumes.






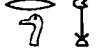





(6) This item may also be translated as "species kind of bread" (JUNKER, H., *op. cit.*, I, 185, 222; II, 83, 170, 172; III, 89; V, 94).

(7) JUNKER, H., *op. cit.*, I, 179, 246 "Brotart" (?); II, 84, 171; III, 84, 99, 101; IV, 25, 26, 88, 89; VII, 78, "eine Frucht"; B. VANDER WALLE, *op. cit.*, p. 68, "Painsronds".

(8) Junker gives the various translations of "cake", "kind of bread", "kind of fruit" and finally "food" (JUNKER, H., *op. cit.*, I, 147, 179; II, 84, 171; III, 98-102; IV, 25, 26, 88, 89; V, 94, 104, 130, 145; VI, 113; VIII, 104, 150; B. VANDER WALLE, *op. cit.*, p. 68, "petit pain en forme fuseau").

(9) JUNKER, H., *op. cit.*, I, 246; II, 83, 84, 170, 171; III, 99, 100, 102; IV, 26, 89; V, 94, 96, 104, 144; VII, 78, 168; VIII, 106; B. VANDER WALLE, *op. cit.*, p. 69, "grains blancs".

(10) Always presented in connection with the former item; B. VANDER WALLE, *op. cit.*, p. 70, "grains verts".


- (18)  "W^h-fruit (1)".
- (19)  "Bibwt-fruit, two bowls (2)".
- (20)  "Vessel (3)".
- (21)  " ? ? ? ?"
- (22)  "Cranes".
- (23)  "rj-geese, one thousand (4)".
- (24)  "Nbs'-fruit, three bowls (5)".
- (25)  " ? ? ? ?"
- (26)  "Figs, one basket (6)".
- (27)  "Oryx leucoryx, one thousand (7)".
- (28)  "Young calves, (one thousand) (8)".






(1) This unidentified fruit is shown once kept in stores, and also in granaries as in the row at the bottom of this register (JUNKER, H., *op. cit.*, II, 62, 78, 83, 84, 170; III, 84, 99, 102, III; IV, 26, 67, 89; V, 51, 55, 96, 100, 160; VIII, 121); B. VANDER WALLE, *op. cit.*, p. 70, "Gousse de caroubier"; Loret identified it as "sebestos", LORET, V., "Recueil de Travaux", XV, p. 117.

(2) JUNKER, H., *op. cit.*, II, 172, "Kernel-fruit"; III, 84, 101, "bibwt", IV, 26, 89; VI, 114; B. VANDER WALLE, *op. cit.*, p. 70, "Lentilles" (?).





(3) It is an uncommon item and transliterated either as "hwt" or "whi" (JUNKER, H., *op. cit.*, I, 107, 230, 259; IV, 65).





(4) The writing of this and the former item is given as if both belong to one group; in this case rj "thousand" must refer to both. For both items, compare JUNKER, H., *op. cit.*, I, 253; II, 83, 84; III, 99; V, 104; VI, 63; VIII, 133.

(5) This is the same fruit which was used in the preparation of the cake or bread mentioned under No. 6. It is once mentioned as a sort of fruit stored in a magazine , (JUNKER, H., *op. cit.*, I, 229, 244, 253, 259; II, 62, 78, 80, 83, 84, 170; III, 82, 84, 99, 102, 184; IV, 26, 67, 89; V, 96, 104, 144, 145, 160; VI, 119, "Christusdorn"; VIII, 121; B. VANDER WALLE, *op. cit.*, p. 70, "jujube").









(6) The wicker basket is rather uncommon; the determinative being usually , , , . It is also once mentioned, very likely in a dry state, stored in a magazine  (JUNKER, H., *op. cit.*, I, 176, 244; II, 83, 84, 170; III, 86, 99-102, 107; IV, 26, 67, 89; V, 96, 100, 130, 144; VI, 113, 237; B. VANDER WALLE, *op. cit.*, p. 69 "liqueur de figues").


(7) JUNKER, H., *op. cit.*, I, 253; II, 93; IV, 183; VII, 75; VIII, 21, "Säbelantilope".

(8) It is evident that an  is lacking; a hypothesis sustained by the vacant space between  and . The numeral  is so inserted in between this item and the former one that it must refer to both of them (JUNKER, H., *op. cit.*, I, 253; II, 75, 83, 84, 129; IV, 112; VI, 65, 126; VII, 75; VIII, 21).

- (29)  "Beer jugs (one thousand ?) (1)".
- (30)  "Bread, one thousand (2)".
- (31)  "Clothing, one thousand".
- (32)  "Alabaster bowls one thousand".

At the bottom of this register is a row of eight granaries with the names of the grain they contain. Beginning from right to left, one reads:—

- (1)  "Upper Egyptian corn, 200".
- (2)  "Lower Egyptian corn, 200".
- (3)  "bsj - corn, 200".
- (4)  "Wheat, 200".
- (5)  "Dates, 200".
- (6)  "ddw, 200".
- (7)  "w'h-fruit " 200 ".
- (8)  "Sweet grains, 200".

(1) The numeral  seems to have been forgotten, as it would have fitted into the vacant space under the sign.

(2) For the arrangement of this and the following items under the offering-table, cf. JUNCKER, H.; *op. cit.*, VII, Abb. 70, 97.

The middle register represents a row of seven persons, walking towards the right, the inner part of the false-door, and each carrying a different offering. The first man on the right holds aloft in each hand a long strip of bandage. In front of him is the word $\overline{\overline{\text{Q}}}$. He is dressed in a short kilt with looped belt and his hair is cut short⁽¹⁾. His name $\overline{\overline{\text{K}}}$ $\overline{\overline{\text{3}}}$ $\overline{\overline{\text{j}}}$ -*htpw* is written above his head. Following this first offering-bearer: a second man, very similar in aspect, brings two long-spouted vessels. This is the funeral priest as shown from the title $\overline{\overline{\text{U}}}$ written beside his figure. His name is $\overline{\overline{\text{I}}}$ $\overline{\overline{\text{3}}}$. Then follows the procession of four female bearers, the first a woman, dressed in a large robe with shoulder-straps, holds with both hands a casket she carries on her head. She wears a long wig. In front of her one reads $\overline{\overline{\text{K}}}$ $\overline{\overline{\text{3}}}$. Then follows a second woman, identical in all aspects with the preceding one, with her name $\overline{\overline{\text{I}}}$ *ir(t)* written in front. The third woman, similarly dressed, carries on her head a basket, out of which appear four leaves $\overline{\overline{\text{U}}}$, which she steadies with her left hand, while the right arm hangs down by her side. Her curious hair-dress ends in a tuft at the back of the head. Before her is her name $\overline{\overline{\text{I}}}$ *it*. The fourth woman is identical with the preceding one, except that she wears a robe which more or less befits a man, and that the basket contains five loaves. There are no hieroglyphs accompanying this figure. The last figure is of a man, carrying on his head a basket which he supports with his left hand, whilst he holds in his right hand a lustration-vase, similar to those held by the *ka*-priest. The third and lowest register shows a row of five women representing the estates of the deceased as is shown by the sign for "estate" \otimes , above the head of each figure. The five women are similarly dressed, in the long robe with shoulder-straps. They all wear the long wig and carry in the left hand a duck which (in all five cases) they grasp by the wings. The first and second hold in the right hand a lustration-vessel with the long spout $\overline{\overline{\text{V}}}$, while the three others hold the *hsj*-vessels $\overline{\overline{\text{V}}}$. Above every figure we find the name of the estate, whilst the space separating every woman from her comrade is inscribed with the different offerings. Proceeding from right to left:—

(1) The name of the estate is $\overline{\overline{\text{K}}}$ $\overline{\overline{\text{3}}}$ $\overline{\overline{\text{E}}}$ $\overline{\overline{\text{S}}}$ *hks-htwt-mst*. The different offerings presented to the deceased from this estate are: five kinds of bread \circ , — , \triangle , \triangle , \odot , beer $\overline{\overline{\text{V}}}$, geese $\overline{\overline{\text{G}}}$, hornless *hrj-db*' ox $\overline{\overline{\text{O}}}$ $\overline{\overline{\text{V}}}$ ⁽²⁾, and an ox with long horns *hrj-s3* $\overline{\overline{\text{O}}}$ $\overline{\overline{\text{V}}}$ ⁽³⁾.

(2) $\overline{\overline{\text{U}}}$ \otimes *grgt* "Establishment": This type of name designates an estate founded by the deceased himself and often it was called after him. Here the latter seems to be lacking⁽⁴⁾. The offerings of this estate are: forelegs of ox $\overline{\overline{\text{L}}}$, baskets of fruit $\overline{\overline{\text{U}}}$, two kinds of bread \triangle , \odot , beer $\overline{\overline{\text{V}}}$, two cranes $\overline{\overline{\text{G}}}$ $\overline{\overline{\text{G}}}$, and a long-horned ox $\overline{\overline{\text{O}}}$.

(3) $\overline{\overline{\text{U}}}$ \otimes $\overline{\overline{\text{N}}}$ $\overline{\overline{\text{F}}}$ *grg tnfr* "Establishment of Nfr": This name is formed according to the rule found in other estate-names⁽⁵⁾. The offerings introduced by the denomination consist of two kinds of bread \triangle , \odot , beer $\overline{\overline{\text{V}}}$, and an oryx antelope $\overline{\overline{\text{O}}}$.







⁽¹⁾ JUNKER, H., *op. cit.*, Abb. 17, 21, 24.

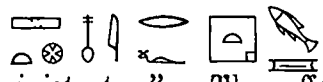





⁽²⁾ cf. *W.B.* III, p. 136.

⁽³⁾ cf. *W.B.* III, p. 135.

⁽⁴⁾ JUNKER, H., "Giza", II, p. 167, Abb. 20.

⁽⁵⁾ JUNKER, H., *op. cit.*, I, pp. 225, 226, 254.

(4)  "dws-n-Int (?)": This is one of the numerous estate-names composed with *Int* as *int-hwfw* and *int-snfrw* (¹). The offerings presented by this estates are: two kinds of bread , , beer , long-horned ox  and crane .


(5)  *grgt-Nfri-Hwt-d-mr* "Establishment of Nfri, palace of the administrator". The offerings introduced by the denomination  consist of two kinds of bread , , beer  and crane .

SIDE OF THE RIGHT WALL, OUTER RECESS IN THE FALSE-DOOR

The scenes on this wall were left unfinished. The blank space was meant to be filled with a standing figure of the deceased, for the lower end of the long staff of command can be seen, drawn in ink (Fig. 39, Pls. XXX-B and XXXII-A).


In the inner top corner a square area shows six columns of hieroglyphs above two low registers representing rows of offerings. The hieroglyphs read:—

- (1) The master of the company of recruits.
- (2) The director of the mercenary guards (?).
- (3) The inspector of the palace, the king's purificator.
- (4) The regent of the great palace, the judge and chief of the police.
- (5) The one seeing Horus (?), the priest of *wadit* (?).
- (6) The royal acquaintance, Nfri.

The register under this list represents a row of different offerings, beginning at the right with two twin-jars of wine, on two low four-footed tables follow a haunch and a thigh. The inscription stretching above them must be understood for both.  "Meat of the offering-table". Four other tables of one single type, a round tray on a conical stand carry different kinds of loaves, triangular, round and oval, a round white mass (cake ?) and a trussed goose or duck.

The lower register shows three round loaves on baskets alternating with five loaves and eight upright triangular loaves. At the end of the row a large jar is backed by two triangular supports. Above the loaves, in the vacant area of this same register, a trussed goose with the pole inserted in its neck, ready to be roasted, has been represented.


At the bottom of the wall two registers, superimposed and running the whole width, show two rows of male offering-bearers walking towards the inner part of the false-door (²).


In the top register, the first figure from the left shows the typical Old Kingdom shepherd. He is naked but for a belt and a strap, his hair is cut short, and he carries on his back a young calf whose forelegs he grasps in both hands, while the hind legs are cramped in his armpits. In front of the shepherd the hieroglyphs read:  *phwj* (?).


(¹) JUNKER, H., "Giza", I, 226; II, 168.


(²) JUNKER, H., *op. cit.*, III, Abb. 27.

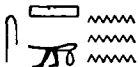
The lower register begins at the left with two huge cylindrical stands, each with a triangular opening in the base, upon each of them are placed two hearts. Eight offering-bearers follow, the first three obviously peasants dressed only in a belt with straps, while four others wear the short kilt. The seventh seems to be quite naked. They all have short hair.


The first carries a long object in his right arm, which is bent over his breast, and in his left arm a bag (?). The figure is preceded by the name :  *Nfr-irw*.

The second figure with both shoulders (?) rabated in front of his breast, holds with both hands a *hs*-jar. The accompanying name reads :  *wnn*.


The third bearer keeps close to his breast a crane which he secures by the feet. His name is :  *hdd*.


The fourth holds a *hs*'-vase and is called :  *hs-ib*.

The fifth is similar to the former and is called :  *ssmw*.


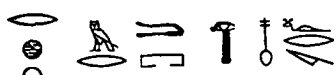
The sixth is called :  *ibi*.

It is worth noting that the four *hs*-vase bearers (the second, fourth, fifth and sixth) are so represented that the inclinations of the vases show the movement of pouring in its different stages. It is a proceeding used in other Egyptian composition where movements are involved, such as those which show troops hurrying or shooting.

The seventh figure seems to be a dwarf characterized by a large head and short legs, carrying in his left hand the sandals and in his right the staff of his master, an occupation usually reserved to such inmates of the household ⁽¹⁾. Above is his name :  *sn (j)-mnh*.

The last figure of the procession is that of a man carrying in his left arm a loaf and in his right a jug. The name  *isw* (?) is written behind him.

THE BACK OF THE INNER RECESS IN THE FALSE-DOOR

The door itself is featured with two uninscribed jambs surmounted by a flat cross-bar with one line of hieroglyphs, reading (Fig. 40, Pl. XXXII-B) : 
  "The master of the company ⁽²⁾, the judge and chief of the police,

(1) JUNKER, H., "Giza", III, Abb. 27, 170.

(2) Probably an abbreviation of the title "Master of a company of recruits" mentioned above.

the royal acquaintance, the director of the mercenary guards (?) Nfri". Under the lintel, the drum is inscribed with one line of hieroglyphs: "The master of the company, the royal acquaintance, Nfri".

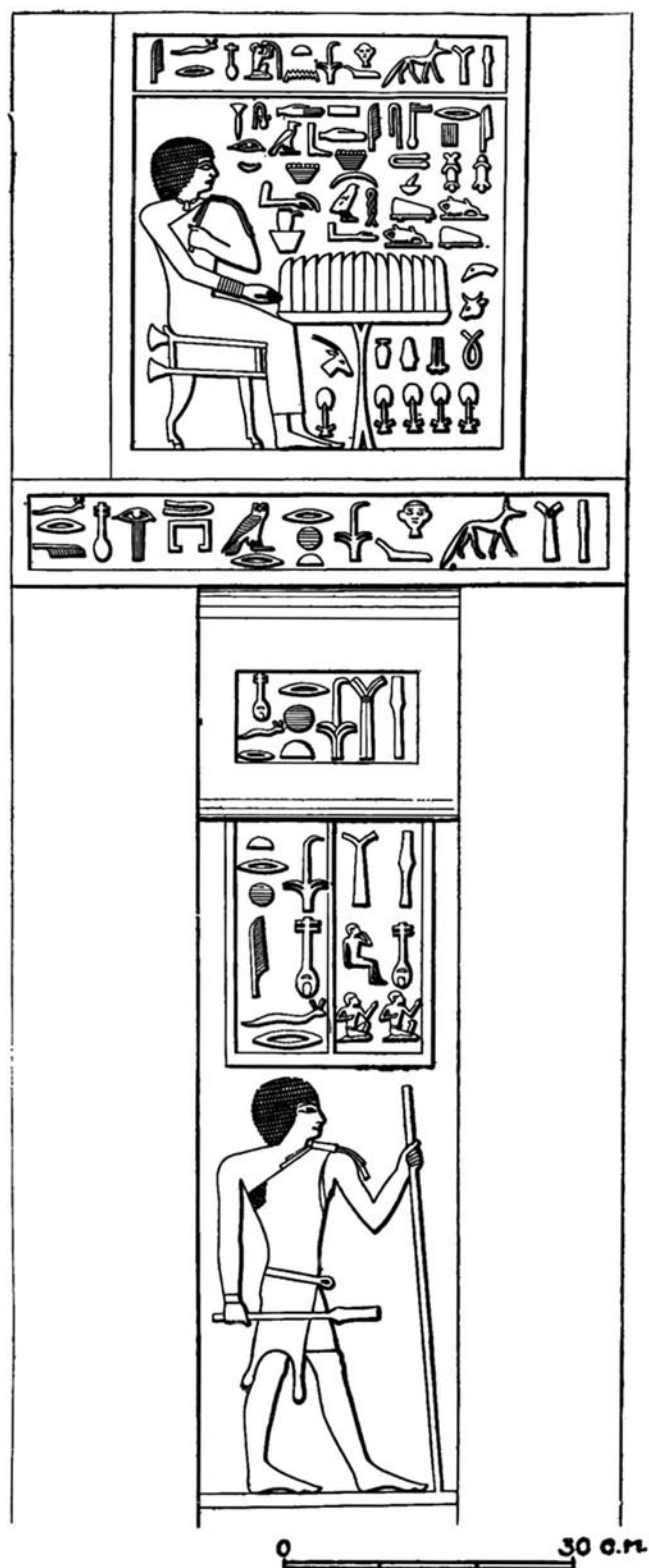
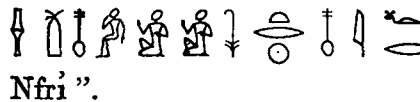


FIG. 40

The back of the inner recess represents the figure of Nfri (Pl. XXXIII) standing, looking to the right, in the garb of a *sm*-priest. The head shows a short graded wig. As (already featured in the figures) on the façade of the outer jambs, Nfri holds in the left hand the staff of command and carries in his right, adorned with the wrist band, the *hrp*-sceptre. The dress consists, beside the short kilt, of a leopard-skin, a looped belt and on the left shoulder a knot resembling the kerchief (¹), which appears carried on the shoulder in the left scene on the side of the outer recess.

Above the figure two columns of hieroglyphs give his name and some of his titles :

 "The director of the company of recruit, the royal acquaintance, Nfri".

The tablet above the cross-bar is of a usual type, representing the deceased seated on a chair and partaking of the funeral offerings. He is dressed in a long robe hung over the left shoulder and stopping above the ankles. The right hand is extended to the offering-table and the wrist shows a bracelet consisting of a series of seven rings (Pl. XXXI). The left arm is bent upon the breast and the hand holds what seems to be the knot fixing the robe to the left shoulder (²) similar to the one Nfri holds in the scene on the left side of the outer recess. Round the neck hangs a string of beads with a central pendant (³).

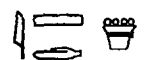
The chair presents the uncommon peculiarity of having the seat rabated so as to appear in plan with its frame and the two arm-ends featuring lotus-flowers.

The offering-table is of a usual type. It is laid on a thin stand with upper and lower triangular apertures.


In horizontal lines are the names of a few offerings :—

(1)  "Wine, 2 jars".

(2)  "Incense".

(3)  "isd-fruit".

(4)  "Figs".


















(5)  "Green kohl".

(6)  "w'h-fruit".

(¹) JUNKER, H., "Giza", V, Abb. 5 b.

(²) JUNKER, H., "Giza", I, Abb. 31; *op. cit.*, V, Abb. 5 b.

(³) JUNKER, H., "Giza", VII, Abb. 75, a, b.

- (7)  "Ablution water".
- (8)   } "Trussed geese and meat".
- (9)   }
- (10)  "Head of goose".
- (11)  "Head of an ox".
- (12)   "A thousand alabaster vessels".
- (13)   "A thousand pieces of linen".
- (14)   "A thousand loaves of bread".
- (15)   "A thousand jugs of beer".
- (16)   "A thousand oryx antelopes".

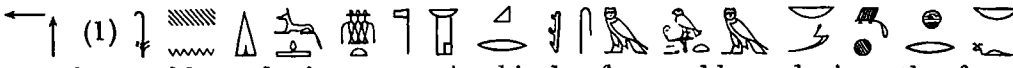
At the top of the tablet a line gives some titles : "The master of the company, the judge and chief of the police, king's purificator, Nfri".

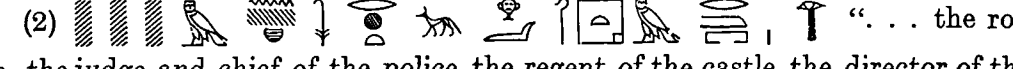
THE WOODEN FALSE-DOOR OF NFRĪ (Fig. 41-A, B)

On page 40, I mentioned the wooden false-door found recessed in the southern part of the eastern face of the first plan. It was in a bad condition and only five inscribed pieces were reserved (Fig. 41-A, B, Pls. XXXIV, XXXV).

The best preserved fragment of this door is the lintel. It contains in the middle three horizontal lines of hieroglyphs. On the right hand, traces of three female offering-bearers are still visible ; on the left hand, the head and shoulders of Nfri are beautifully carved with one line, running horizontally above his head and the upper part of two vertical lines in front of his face.

The three horizontal lines are :—

 " May the King be favourable and give, may Anubis be favourable and give, the foremost of the divine booth, a burial in the necropolis as a possessor of honour with his lord".

(2)  ". . . the royal acquaintance, the judge and chief of the police, the regent of the castle, the director of the mercenary guard (?)".

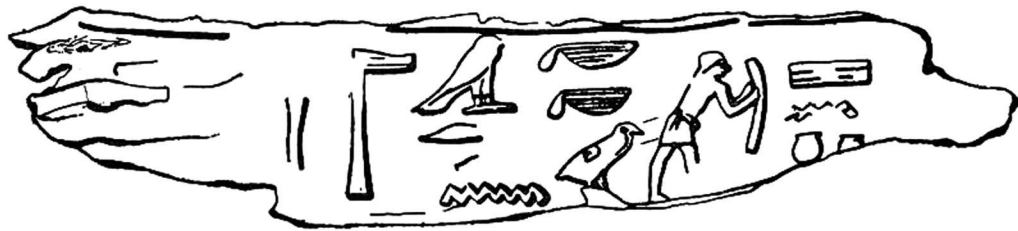
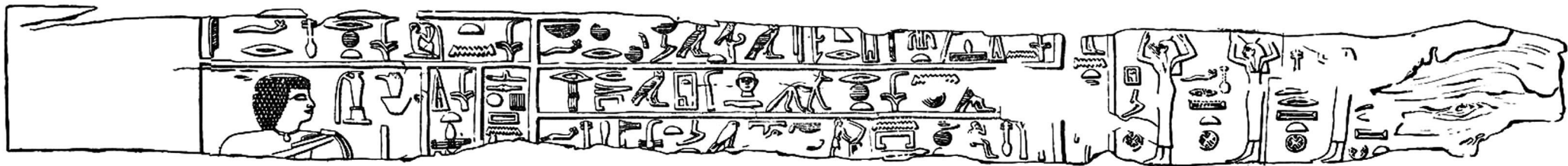



FIG. 41-A




FIG. 41-B

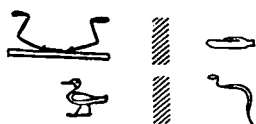
The fourth inscribed fragment of the wooden false-door is a small piece with one horizontal line, running, from right to left, as follows: 

I mentioned above (*cf.* footnote, p. 66) that these hieroglyphs are titles of Nfrī, which are not understood to me.

The fifth inscribed fragment is a long piece of wood with three superimposed figures. The first figure from above is damaged and only his legs are visible.

The second figure is of a man dressed in a simple kilt and holding in his right hand a stick and in his left a pair of sandals. Above him runs a line of hieroglyphs as follows: 

The third figure is of a man dressed in a simple kilt and holding in each hand a duck. Above his head is a line of hieroglyphs, with the following signs:—




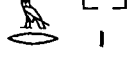
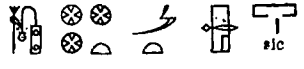





I must confess that both lines written above the heads of both figures (the second and the third) are not understood.


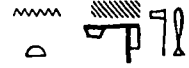



[This page is intentionally blank.]

MASTABA OF 3BDW

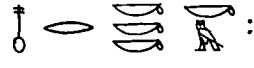
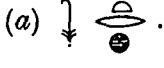
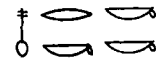
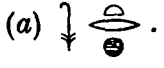

TITLES AND EPITHET OF *3bdw*

1.  "Royal acquaintance".
2.  "King's purificator".
3.  "The director of the great house".
4.  "The director of the house".
5.  "The scribe of the new cities of the great house".
6.  "The honoured by the great god".
7.  "The honoured by his lord".
8.  "The scribe of the great house".

THE TITLES OF THE WIFE

1.  "The royal acquaintance".
2.  "Priestess of Neith".
3.  "Priestess of Hathor".
4.  "The honoured one".
5.  "The honoured by her husband".

TITLES OF OTHER PERSONS

1.  : *Nfr-K3w-Km.*
 (a)  . "The royal acquaintance".
2.  *Nfr-K3w.*
 (a)  . "The royal acquaintance".
 (b)  "The scribe".

SITUATION

South of the Mastaba of Nfri' (*see* General Plan) lies the Mastaba of *šbdw* (Fig. 42).

DESCRIPTION

The plan (about $10.15 \times 6.85 \times$ height 3.05 metres) shows clearly two stages of construction. The first stage consists of a mastaba with a corridor on the eastern face and an entrance at its northern end. The owner added along the eastern side a large chapel of the same length. The chapel is separated from the street running north and south by a superstructure of the same length as the mastaba and similar in construction to those of a real mastaba, but possessing two pits, do not reach lower than ground level. A narrow corridor runs between this pseudo-mastaba and the chapel.

PSEUDO-MASTABA

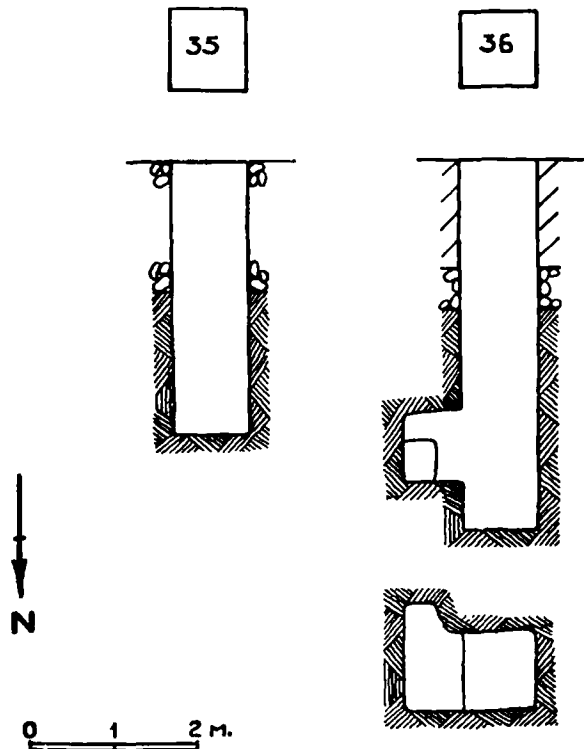


FIG. 43

It is rectangular in plan (about 5.50×2.40 metres) and built of local nummulitic limestone enclosing a filling into which two unfinished pits Nos. 35 and 36 (Fig. 43) are sunk. The four faces are vertical and in the eastern one are inserted three false-doors, which are badly weathered. The middle one still retains on its drum the inscription $\downarrow \text{---} \text{---} \text{---} \text{---}$ "The royal acquaintance, *šbdw*". This inscription proves that the superstructure really forms part of the complex of the Mastaba of *šbdw*.

THE CHAPEL

The entrance to the chapel was through the passage between the southern face of Nfri's Mastaba and the northern face of that of *šbdw*. It is now blocked at its eastern end by an additional construction of the same breadth

as the pseudo-mastaba (length 1.30 metres) and containing a pit No. 34 lined with bricks on three of its faces. A false-door is also inserted into its eastern face (*see* General Plan).

One enters the chapel through the above-mentioned passage to the narrow transversal corridor about 6.60×0.75 metres, which lies between the pseudo-mastaba and the chapel. It leads to the entrance door ($0.60 \times 0.60 \times$ height 1.80 metres), opening at the southern end of the eastern face of the chapel. All the walls of this chapel are vertical and built of big limestone blocks, the dressing of which is unfinished.

The chapel ($4.50 \times 2.10 \times$ height 2.25 metres) occupies the whole length of the mastaba and consists of a rectangular hall with two pillars ($0.40 \times 0.35 \times$ height 2.25 metres) square in section, along its longitudinal axis (Pls. XXXIX, XL). This chapel was roofed

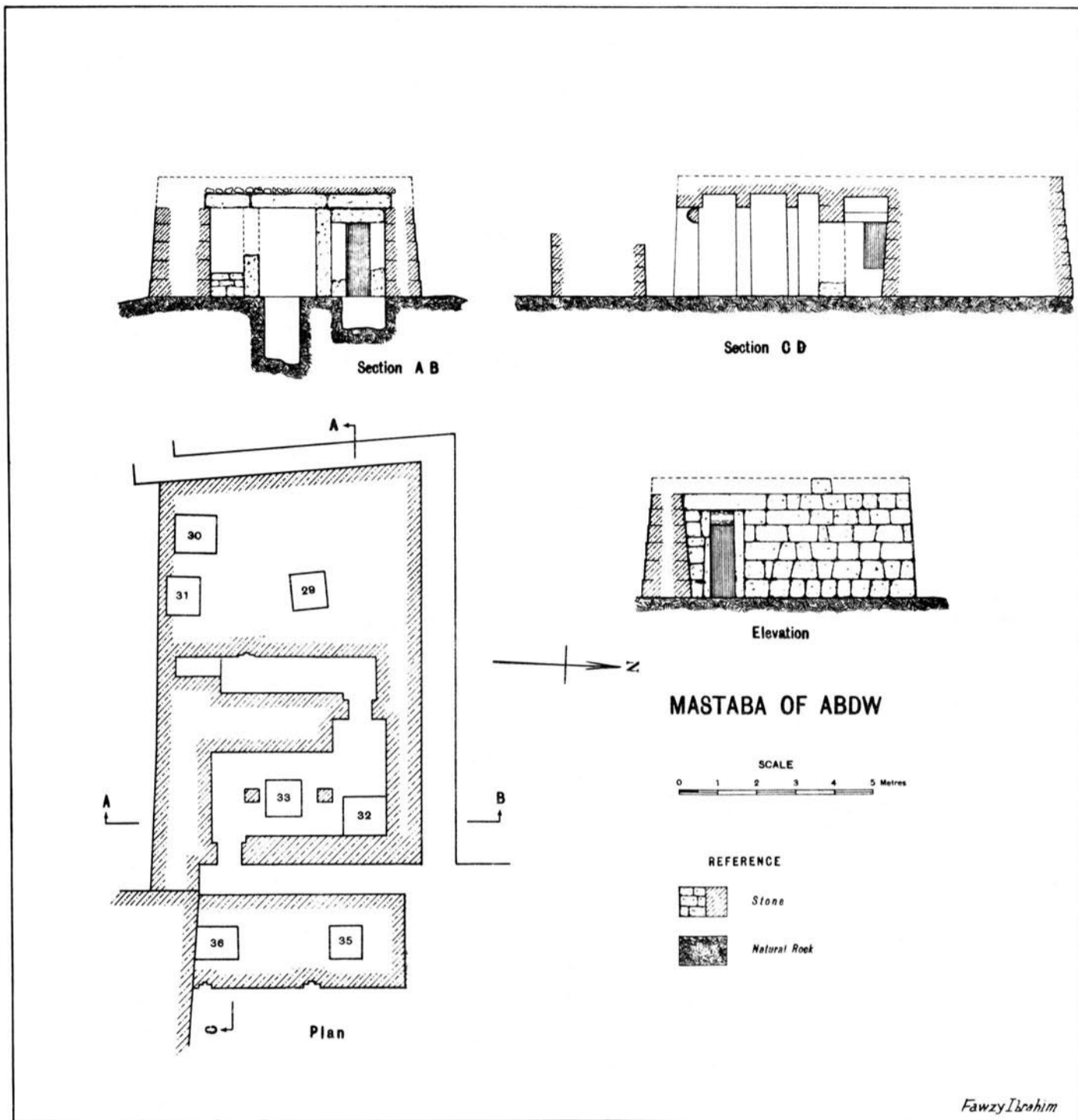
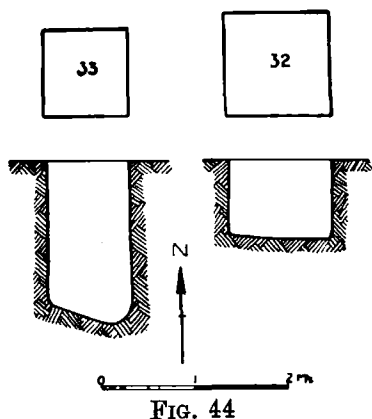


FIG. 42

with long slabs, most of them found in situ. They were placed in two rows on either side of a stone beam running south-north upon the two pillars.

The only parts of this chapel, which bear inscriptions, are the lintel on the entrance door, the drum, the two jambs and the four faces of each pillar. The scenes are characterized by the treatment of the individual figures, of which all the hands are drawn wrongly ⁽¹⁾.

SHAFTS IN THE CHAPEL



Shaft No. 32 (Fig. 44):

Unfinished shaft: 1.10 × 1.00 × depth 0.75 metres.

Shaft No. 33 (Fig. 44):

Unfinished shaft: 0.90 × 0.90 × depth about 1.70 metres.

SHAFTS OUTSIDE THE MASTABA

Shaft No. 29 (Fig. 45):

Unfinished and unused shaft: 0.90 × 0.90 × depth 5.90 metres.

Shaft No. 30 (Fig. 45):

Unfinished shaft: 1.00 × 1.10 × depth 3.05 metres.

Shaft No. 31 (Fig. 45):

Unfinished shaft: 0.90 × 1.00 × depth 4.55 metres.

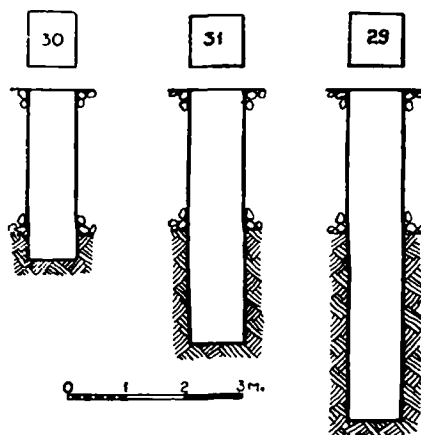


FIG. 45

THE MASTABA

Access to the mastaba is gained through a door (0.60 × 0.60 × height 1.85 metres) in the northern corner of the chapel. It opens into the corridor (4.00 × 0.90 × height 2.25 metres), running along the eastern face of the mastaba. At its southern end a false-door is set, tapering in the graded face of the mastaba.

THE SERDAB

It consists of a cachet (1.20 × 0.55 × height 1.70 metres) formed in the masonry at the back of the wall ending the corridor to the south.

(1) SMITH, W. S., "A History of Egyptian Sculpture and Painting in the Old Kingdom", 1946, p. 278, Fig. 117.

On both sides of the entrance door are four vertical lines of hieroglyphs, two on each side. The two lines on the right hand run as follows (Fig. 47, Pl. XXXVII):—

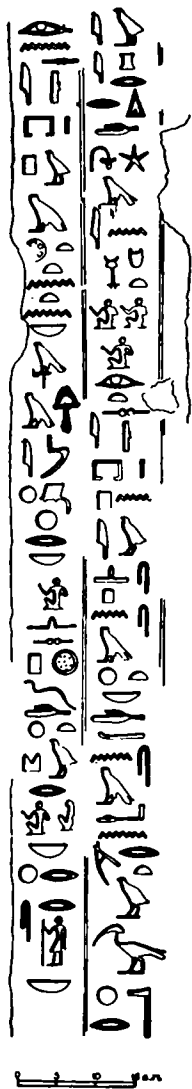


FIG. 47

(1) "I have made this chapel in this city (1) of (my) lord (2), in the shade of my honour by my lord. Never have I spoken badly against any body in the presence of any chieftain".

(2) "I caused that God may be praised by the artisans who have made this chapel (3), I contented them in every thing (4) they asked me, in order that I might be glorified by the god (5)".

The two lines on the left hand run as follows (Fig. 48, Pl. XXXVI):—

(1) "The director of the house, ʒbdw, he says (6): A beloved (7) one of Anubis is he who will enter (8) this chapel. He will eat bread and drink beer there (9) . . .",

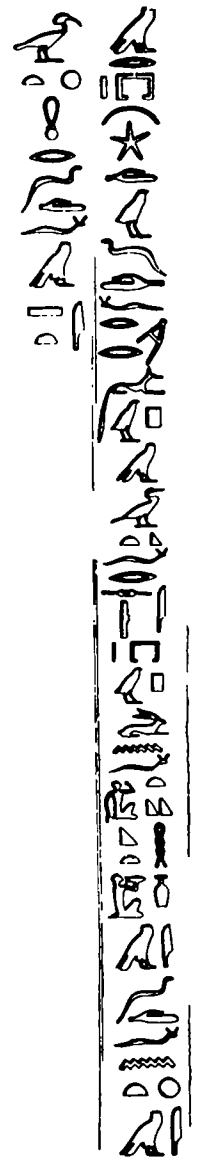
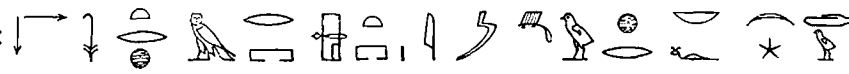


FIG. 48

(1) It was only once mentioned in Urk., I, 754 15 (4th Dynasty) and means "Necropolis". The name of the Cheops-Necropolis is also written with Ⓞ as a determinative sign (cf. Urk., I, 66-5).
 (2) *njt-nbwj*; for this reading, cf. Urk., I, 180, 3.
 (3) Better, perhaps, to be read *ʒiw* (cf. pyr. 1105 d). For this form compare also Urk., I, 51, 2 and S. HASSAN, "Excavations at Giza", 1930-31, pp. 173, 213.
 (4) It is well known that artisans usually "praised" god when payment or treatment was good, cf. Urk., I, 50; 70; 271 and JUNKER, H., "Giza", IX, 73.
 (5) cf. Urk., I, 23, 9; A. FAHREY, "Sept Tombeaux", p. 21.
 (6) cf. Urk., I, 188, II.
 (7) *ʒdl-f*, for this reading, cf. Urk., I, 23, 11 (N.N.); J.E.A. 33, Pls. 2, 5 ().
 (8) *Mrrw*, for the reading, cf. Urk., I, 198, 5.
 (9) *m-ʒti-f-ir-is-pw*: The use of "m" before the subject is also to be found in Urk., I, 198, 5, 197, 13; S. HASSAN, "Excavations at Giza", 1930-31, p. 173. It seems that "m" is used to express the idea of "whoever" instead of simply "who".

the long staff rounded at the top, his left erroneously drawn, hangs by his side. Above him:  "The royal acquaintance, the overseer of the great palace, the honoured by his lord, ʾbdw".

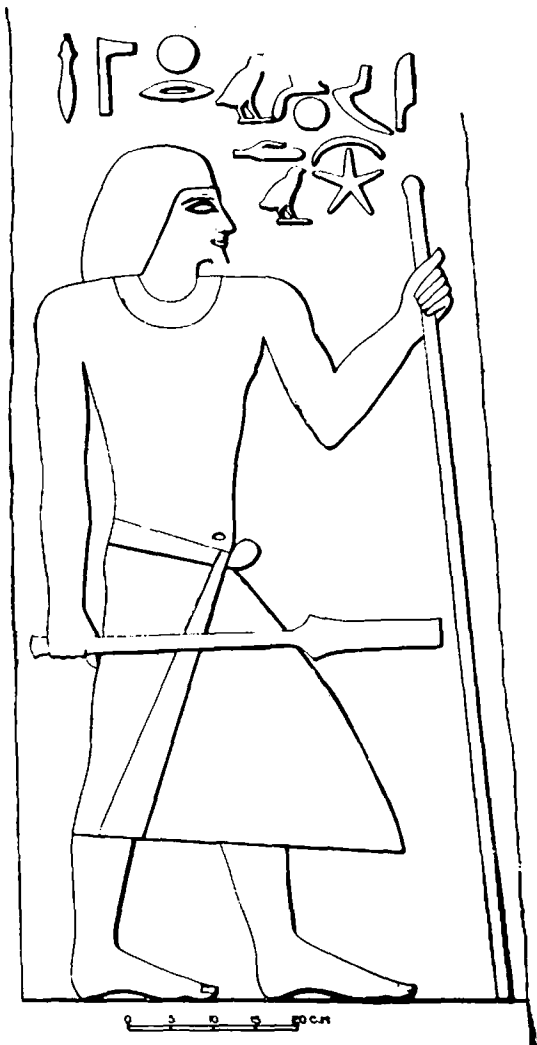


FIG. 50

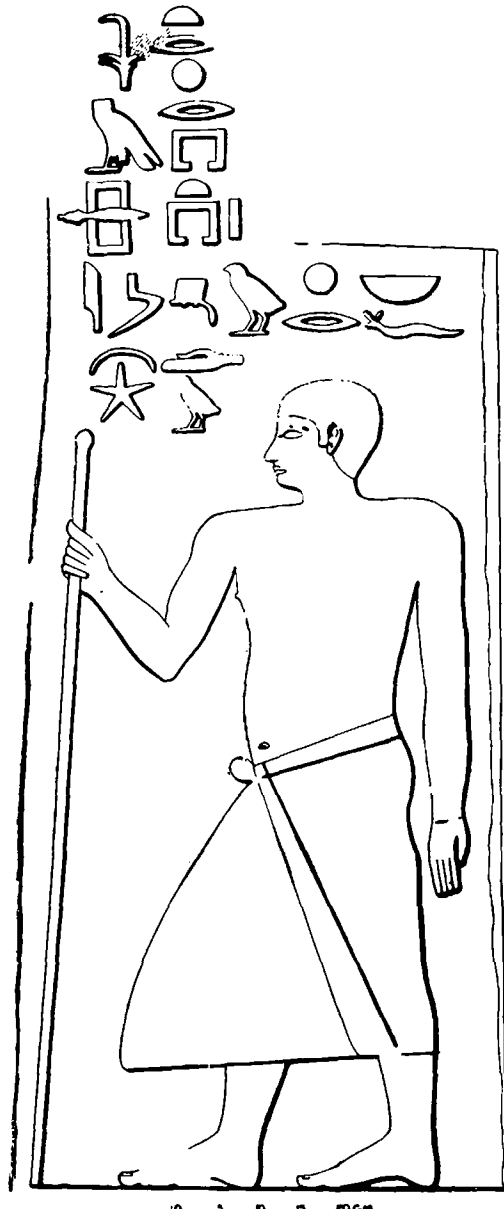


FIG. 51

THE NORTHERN PILLAR IN THE FIRST HALL

Every face of the pillar, on square plan, is sculptured in low relief with a vertical scene resting on a low square one. At the top of each scene a series of hieroglyphs gives titles and names.

The Eastern Face (Fig. 52):

In the upper panel the deceased is seen standing facing left, represented in the realistic manner already met with at the southern side of the doorway. Both arms hang down and his kilt shows a looped belt and a wrapping edge. Above him two horizontal lines of hieroglyphs:—

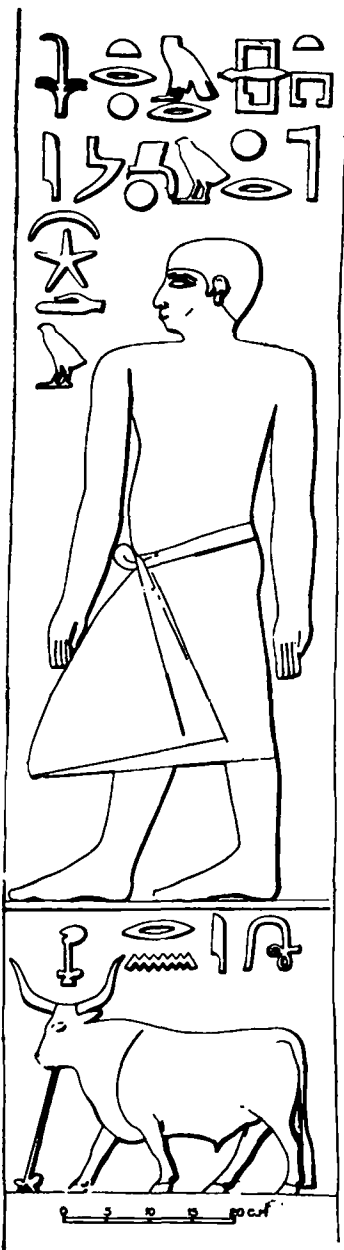


FIG. 52

(1) "The royal acquaintance, the director of the great palace".

(2) "The honoured one with the god, *šbdw*".

In the lower square panel a long horned bull is standing attached by a cord to a ground hobble. Above it:

→ "A thousand of young bulls".

The Western Face (Fig. 53, Pl. XLI-A):

The deceased is again represented looking left, but in a formal attitude, and a stylised form, wearing a long wig and a short kilt with looped belt. He is leaning upon his long staff, his left hand against its rounded head and his right arm resting loosely along it. The features of the face with its long heavy nose, its wide horizontal mouth indicate a man of the common people. Above the figure are two lines of hieroglyphs:—

(1) "The royal acquaintance, the overseer of the palace".

(2) "The scribe of the new towns, *šbdw*".

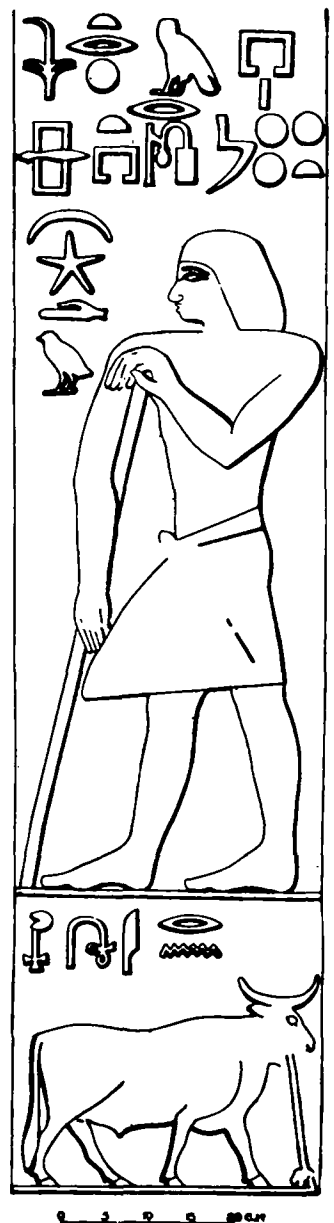


FIG. 53

In the lower square panel a short-horned bull is seen attached by a cord, with an inscription:

← "Young bulls; one thousand".

(1) For this writing, cf. "Annales du Service", XVII; p. 26.

The Northern Face (Fig. 54):

In the vertical panel the wife of the deceased is shown standing and looking to the right. She is dressed in a long gown, wearing a long wig and many round necklace rows.

Her left arm is bent over her right breast, her right hangs along her side. At both hands a bracelet or a wrist-band is to be seen. Above her: → ↓ ♂ ♀ ♂ ♀

♂ ♀ ♂ ♀ ♂ ♀. "The royal acquaintance, the honoured one, his wife, his beloved, *rpwt-k3*".

In front of her, a figure on a smaller scale and standing on a line above ground level, represents a boy dressed in a short kilt, (and having) both arms hanging down. Above him are hieroglyphs partly damaged: → [↓] ♂ ♀ ♂ ♀ ♂ ♀

♂ ♀ ♂ ♀ ♂ ♀. "The royal acquaintance, *Nfr-k3w-km* (1)".

On the lower register there are two identical women standing, facing to the right, each wearing a long wig, and a long robe, holding the left arm to the right breast, with the right arm hanging down.

In front of the first woman, a column of inscriptions reads: → ↓ ♂ ♀ ♂ ♀ ♂ ♀ (2)

"Her daughter, *Ni-m3't-ht-hr*".

The other figure shows also a daughter: → ↓ ♂ ♀ ♂ ♀ ♂ ♀ (3) "Her daughter, *Nbt-m-pt*".

In the lower square panel is an animal whose picture is very damaged.

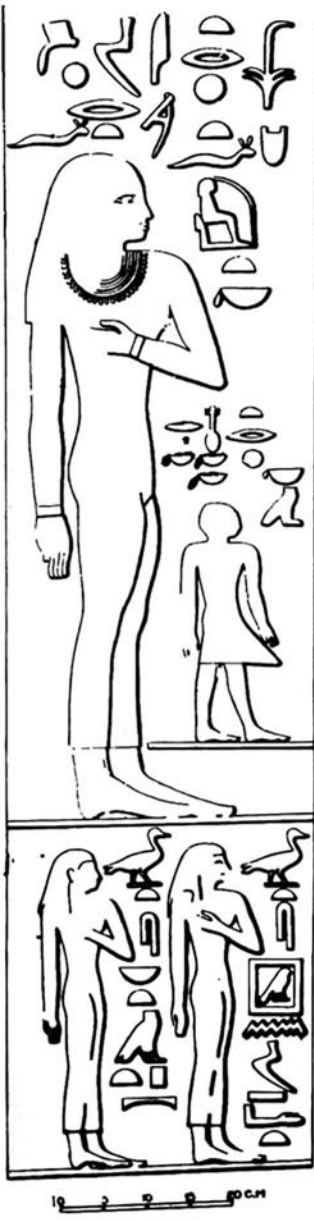


FIG. 54

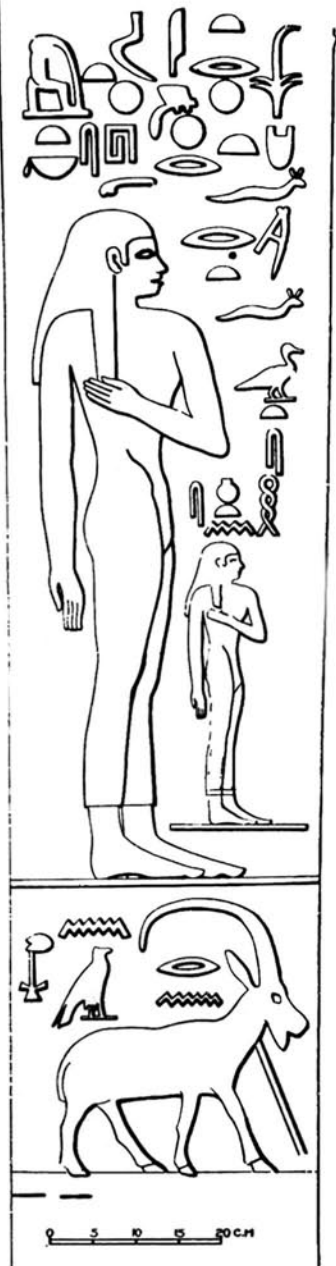


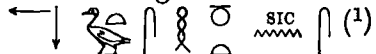
FIG. 55


The Southern Face (Fig. 55):

The wife is again represented in an attitude identical to the one she had on the northern face. Above her: → ↓ ♂ ♀ ♂ ♀ ♂ ♀ ♂ ♀ ♂ ♀ ♂ ♀

♂ ♀ ♂ ♀ ♂ ♀. "The royal acquaintance, the honoured one by her husband, his wife, his beloved, *rpwt-k3*".

(1) The lady *rpwt-k3* had two sons with the name *Nfr-k3w*; the one mentioned here has the quality of being *km* "black" (cf. RANKE, H., "Personennamen", p. 344).
 (2) RANKE, H., *op. cit.*, p. 172.
 (3) RANKE, H., *op. cit.*, p. 188.

In front of her is a small figure of a girl with a long wig and a long robe, holding her left arm to the right breast and her right arm hanging, represents another of her daughters:  (1) "Her daughter, Hnwt-sn".

Under this scene a long-horned antelope, attached by a cord, has its name specified thus:  "Young... one thousand".

THE SOUTHERN PILLAR IN THE FIRST HALL

The upper part of this pillar was missing at the time of excavation. Later on the missing part was found in a dump-hole of the Harvard University expedition and was put in its place on the still found part in the chapel. The decoration of this pillar is similar to that of the northern one.

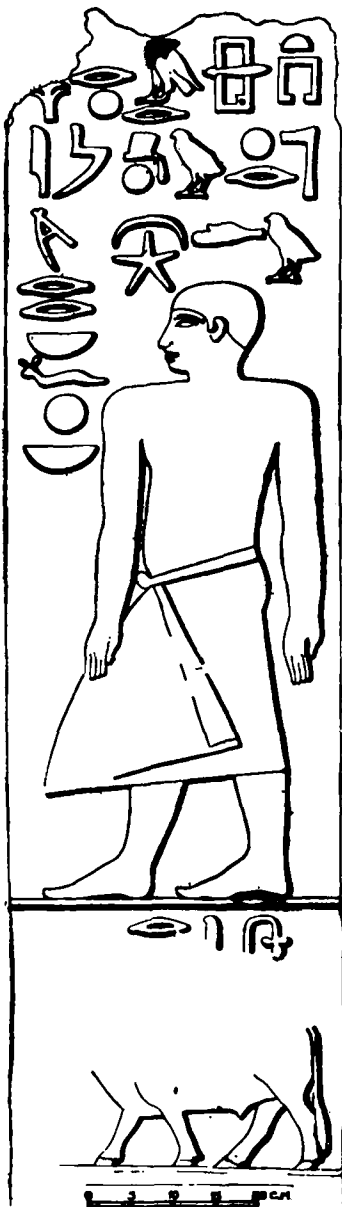


FIG. 56

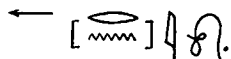
The Eastern Face (Fig. 56):

In the upper panel the man is shown in a walking attitude, looking left, with both arms hanging down, and the open left hand erroneously shown as a right one. He is dressed in the rounded protruding kilt. The bare upper part of the body is shown with the realistic feature of a fat belly. The head is bare and the features of the face are those of a commoner. Above him:



"The royal acquaintance, director of the great palace, honoured by the god, whom his lord loves every day, *sbdw*".

In the lower square panel a cow walks to the left. The upper part of the body is badly damaged. Above it:



The Western Face (Fig. 57):

The owner of the tomb is seen alking to the left, both arms hanging

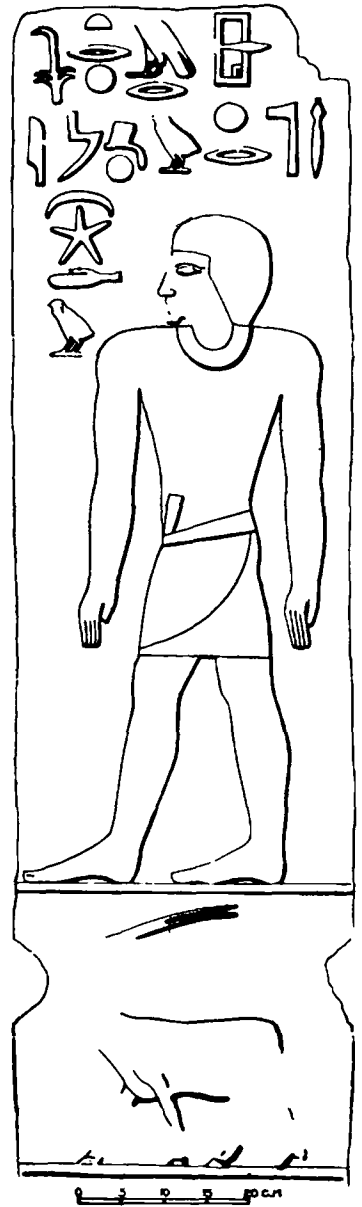


FIG. 57

(1) RANKE, H., *op. cit.*, p. 244.

down, the open left hand erroneously shown as a right one. He is dressed in a short kilt and wears a small wig and a collar around the neck. The features are those of a commoner. A short beard is shown. Traces of the red ochre outline are to be seen. Above him :

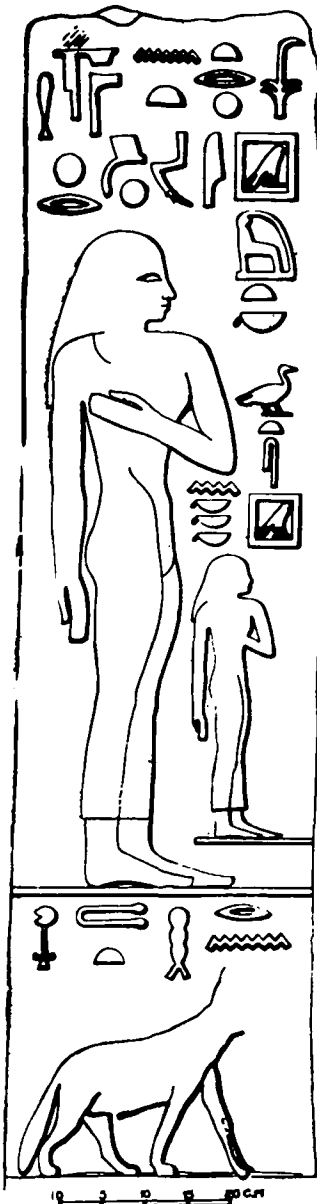


FIG. 58

← ↓ "The royal acquaintance, the director of the great house, the honoured one by the great god, ʒbdw".

In the lower square panel only traces of an animal (cow ?) remain. The outline is in red ochre.

The Northern Face (Fig. 58, Pl. XLI-B) :

On this face we see the wife of the deceased standing looking to the right, the right arm hanging with the hand open and shown wrongly as a left hand. The left arm is bent over the breast. The woman wears a long wig and is dressed in a long robe reaching down to above the ankle. In front of her stands a girl on a higher level and in a similar posture. Above the figure of the wife :

← ↓ "The royal acquaintance, the priestess of Neith (?) the honoured one by Hathor, *rpwt-kʒ*".

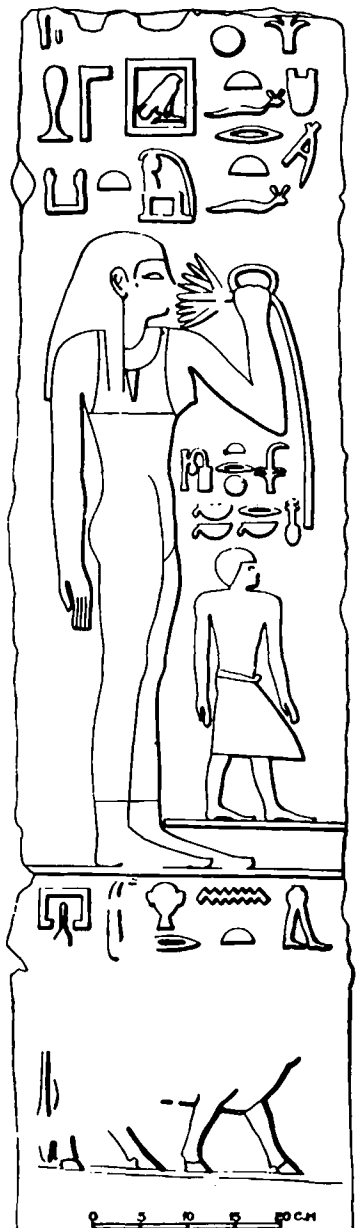


FIG. 59

Above the girl: ← ↓ (1) "Her daughter, *Nj-kʒw-htʒr*".

In the lower square register a hyena is walking to the right. The head is lacking. The body shows traces of reddish brown, the background was grey. Above it is a horizontal line of hieroglyphs : ← "Young hyena, one thousand".

The Southern Face (Fig. 59) :

Here once more the wife of the deceased is shown standing looking to the right, her right arm hanging down with opened hand. Her left one, raised to the level of the nose,

(1) RANKE, H., *op. cit.*, p. 173 (cf. *nj-sw-t-pt*).

The southern end of this register is in a bad state. It shows the deceased seated in front of a selection of offerings (Fig. 61).

At the left corner he is seen sitting comfortably in a large arm-chair with a high back. He is looking to the right as in the conventional scene of the presentation of offerings. The forepart of his starched kilt hangs down at his side. His right arm is bent outside the chair and holds in it a fly-flop. His left one is stretched toward a lotus (?) flower with looped stem presented to him by a servant who stands in front of him and is drawn on a considerably

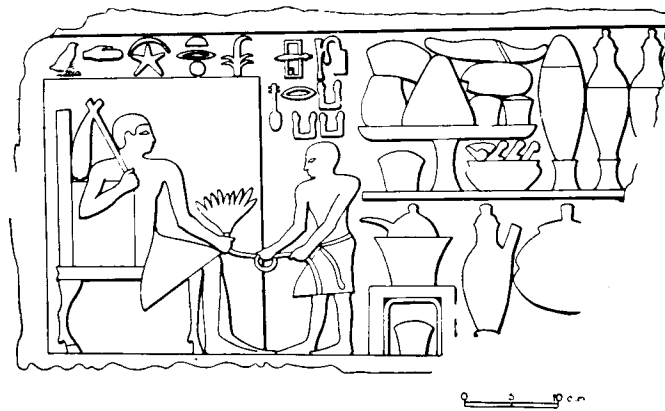




FIG. 61


smaller scale. This servant is dressed in a short kilt and is named according to the hieroglyphs surmounting him: ← ↓  "The scribe of the great palace, *Njr-k3w*".



A rectangular outline frames the deceased, and may perhaps indicate the mat upon which his chair is set. Above him a horizontal line reads (Fig. 61): ← ↓  "The royal acquaintance, *3bdw*".

The right half of the scene shows offerings disposed in two superimposed registers. The top one consists of a low table of the usual type with a large circular tray upon which are heaped different kinds of bread. To the right of this tray are three vases. The lower register shows two vases and a washing vessel placed in its dish.

THE FALSE-DOOR AT THE SOUTH END OF THE WESTERN WALL
OF THE SECOND HALL (Fig. 62)

This false-door is made out of one big large slab of local limestone which has been inserted in the southern end of the western wall.

On the panel we see *3bdw* sitting on a stool, the front feet of which are not shown, being concealed by the feet of the man. He stretches his left hand towards an offering-table set in front of him. Above him: ← ↓  "The royal acquaintance, *3bdw*".

On the right outer jamb : 
 " [May the King] be favourable and grant, may Anubis, the foremost of the divine booth, be favourable and grant, that he may be buried and that he may walk on the good roads on which the honoured one walks, *šbdw*".

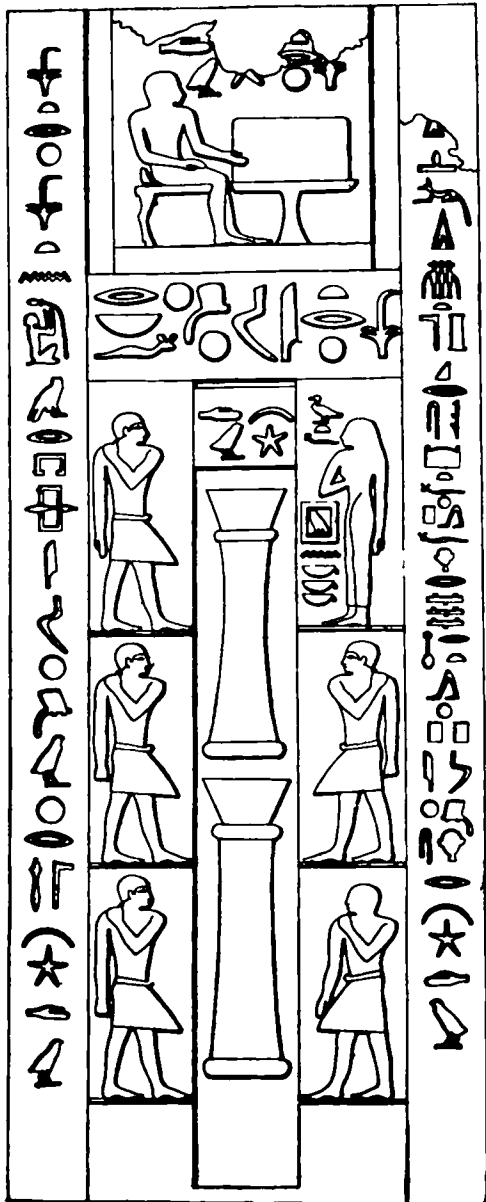
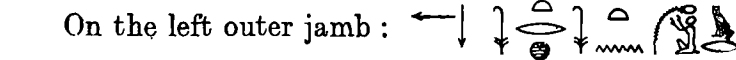
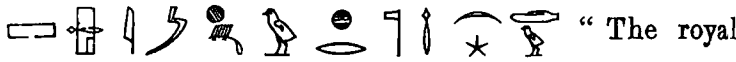
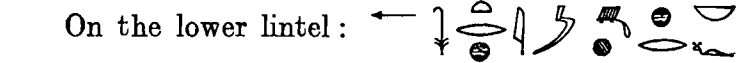
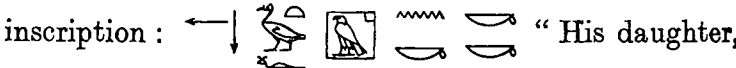


FIG. 62


On the left outer jamb : 
 " The royal acquaintance, the king's purificator, the director of the great palace, the honoured one by the great god, *šbdw*".

On the lower lintel : 
 "The royal acquaintance, the honoured by his lord".

On the right inner jamb we see three figures one above the other, the topmost of a woman with the inscription :  " His daughter, *Ni-ksw-ḥtḥr*".

The two other figures are of men without inscriptions to identify them.

On the left inner jamb we see also three imposed figures of men without inscriptions (to identify them).

On the drum the name of the owner of the tomb  "*šbdw*" is inscribed. Below it we find two superimposed stands for burning incense.

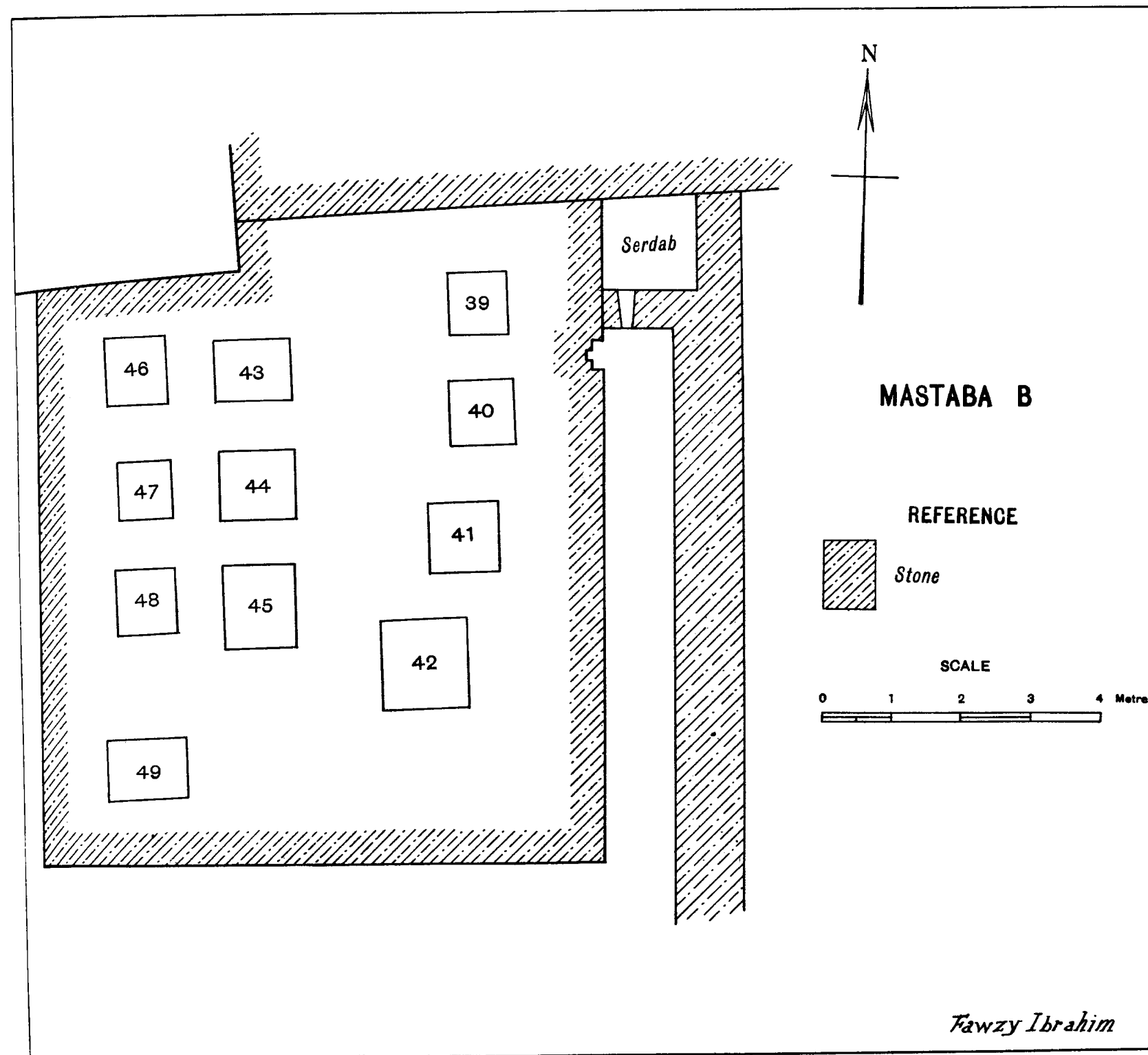


FIG. 63

UNINSCRIBED MASTABA "B"

This is an uninscribed mastaba of local limestone. It lies south of that of *šbdw* (see General Plan). The corridor, running along the eastern side, is reached by a passage running west-east between the southern side of this mastaba and the northern side of an unexcavated stone mastaba.

The mastaba is in a very bad state of preservation, most of its eastern portion being in ruins. The northern false-door is still in place and lies close to the serdab which is found at the northern end of the corridor. The false-door is a rough specimen of the usual type, and is uninscribed (Fig. 63).

The serdab adjoins the southern wall of the Mastaba of *šbdw*, and indeed the western tip of this wall serves as the northern wall of the serdab. It is square in shape ($1.20 \times 1.20 \times$ height about 1.50 metres) and was found opened containing fragments of rotten wood, apparently the remains of statues.

The Shafts : Nos. 39, 40, 41, 42, 43, 44, 45, 46, 47, 48, 49 (Figs. 64, 65, 66, 67).

There are eleven shafts disposed in three parallel rows. The main shaft is the southernmost in the first row to the western corridor No. 42. All the others are unfinished and also unused.

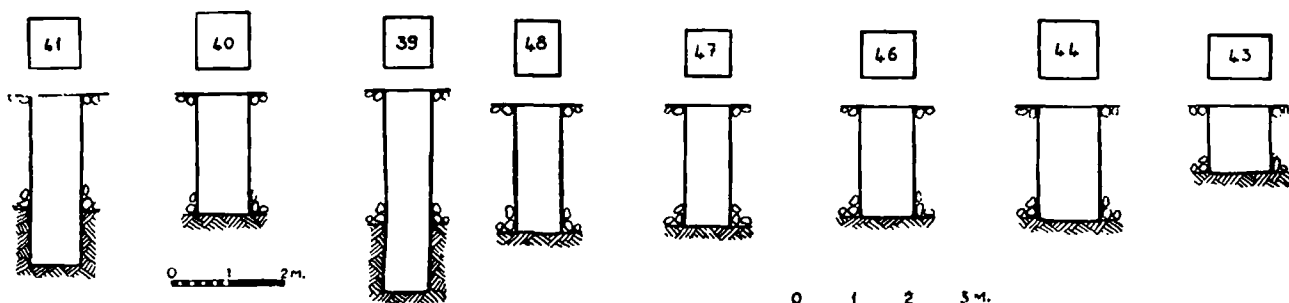


FIG. 64

FIG. 65

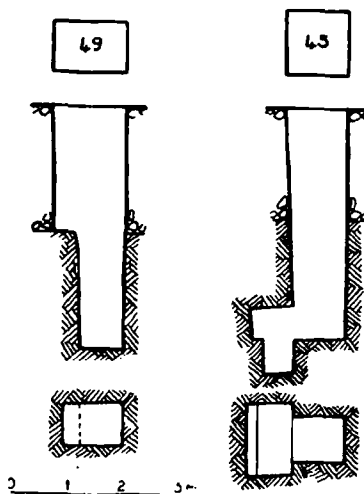


FIG. 66

SHAFT NO. 42 (FIG. 67) (WITH GOLD)

The shaft is entirely dug out of the rock, and the top, which was built in stone, has disappeared with the other ruined portions of the mastaba. At the bottom, on its eastern side, lies the burial-chamber: the entrance to this (1.30 metres) was blocked up by three horizontal rows of stones, the top and bottom rows consisting of large blocks, whilst the middle one was of small stones.

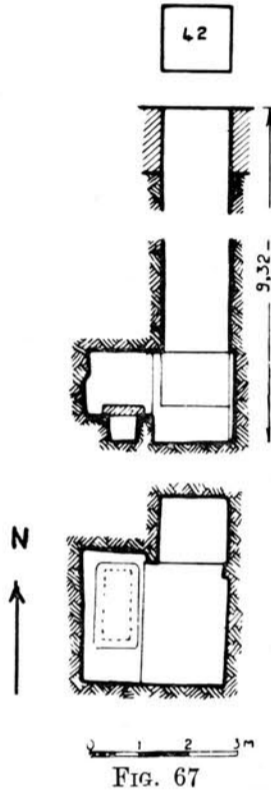


FIG. 67

The floor of the burial-chamber is hewn down to a level (60 cm.) higher than the floor of the shaft, except the southern side which consists of a sarcophagus carved out of the rock and having its upper surface on a level with the bottom of the shaft (Fig. 68).

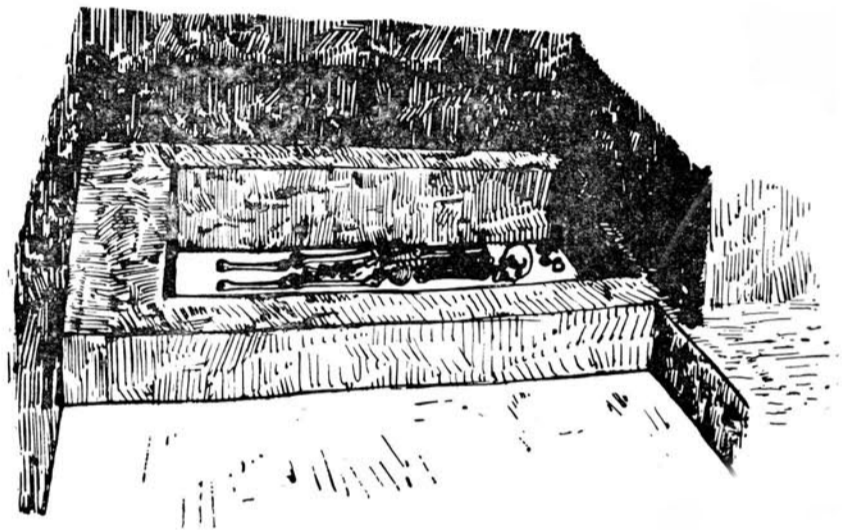


FIG. 68

The lid, consisting of one slab of the same local limestone, was found cemented down.

On the floor in front of the sarcophagus lay some bones of a sacrificial ox, and in the south-eastern corner of the chamber some mud-bricks were found.

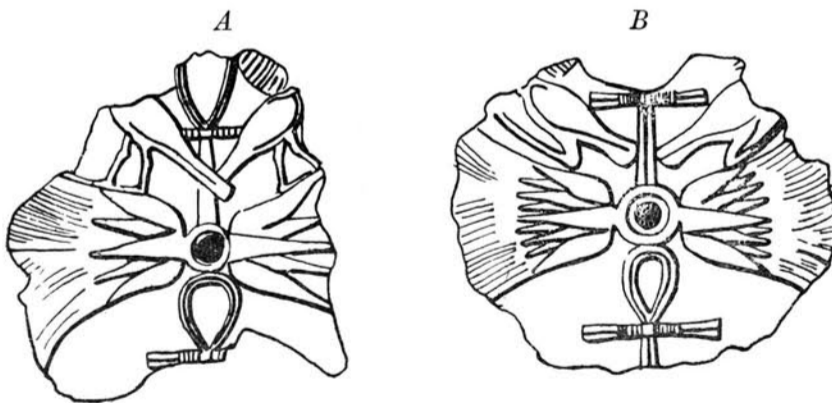


FIG. 69

Within the sarcophagus was a skeleton lying stretched out on its back with the face turned to the east (Fig. 68, Pl. XLII-A). The bottom of the sarcophagus is hewn down to the level of the floor of the chamber.

Underneath and around the skull were found remnants of a disintegrated head band made of stucco and coated with thin leaves of gold (Fig. 69).

It must have consisted of a band round the head surmounted by three round disks, two of which were found preserved. On one of them traces of drawings in black ink are still visible, and show two papyrus flowers, with the sign of life *'nh* between.

Near the fingers of the two hands were found some thin leaves of gold which presumably were used as coverings for the finger-tips. Similar objects were also found near the toes of both feet.

In addition there were some beads scattered along the eastern side of the sarcophagus. Owing to the smallness of their quantity, we can only assume that they come off bracelets and a necklace.

SKELETON FOUND IN SHAFT No. 42 OF THE UNINSCRIBED MASTABA "B"

By

DR. F. ABADIR

The skeleton belongs to a middle-aged male of a height about 1.60 metres. The long bones were quite normal but muscular impressions were not well marked. The articular surface of the heads of both femora was scalloped over the neck. The skull with a cephalic index of 80 was normal in shape. The mouth carried 28 teeth, the wisdom did not erupt. All the teeth showed signs of attrition, with the exception of the upper and lower molars.

The air sinuses in the skull are extensive and enlarged at the expense of the bone. The frontal air sinus extended into the roof of the two orbits as it sometimes does.

The interesting thing discovered in this skeleton is the wedge-shaped body of two vertebrae. Professor Hamada, who was kind enough to transfer this fragile skeleton carefully from its burial-place to the top, noticed the kyphotic condition of the spine, and consequently the present deformity of the two vertebrae.

On examining the vertebral column (Pls. XLIII and XLIV), it was found that the bodies of the 10th and 12th dorsal (thoracic) vertebrae exhibited a wedge-shaped appearance by virtue of compression from above downwards, the apex of the wedge being in front (Fig. 70, Pl. XLII-B). The intermediate vertebra (the 11th dorsal) showed very slight compression in front but most pronounced was the lipping of its upper and lower borders. The same condition of osteophytic changes was noticed in the vertebral column along the position of the anterior longitudinal ligament. No other abnormality was noticed.

Conclusion :

The enlargement of the air sinuses of the skull, the osteophytic changes of the vertebral column, suggests that a condition of chronic rarefaction has taken place, which leads to gradual compression of the 10th and 12th thoracic vertebrae, causing this wedge-shaped appearance and the kyphotic condition of the vertebral column as a whole.

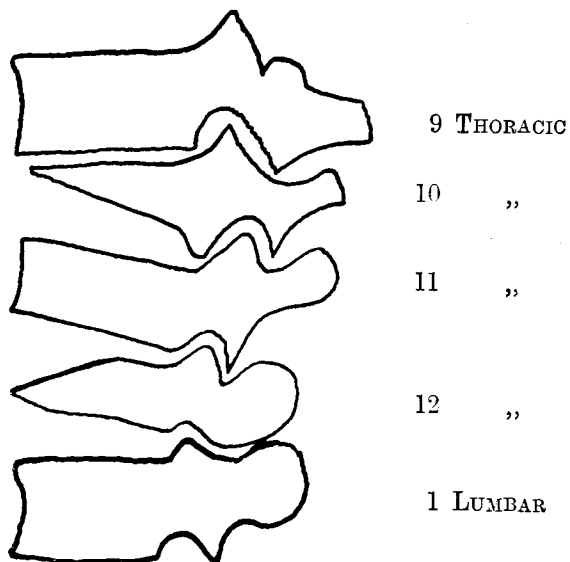
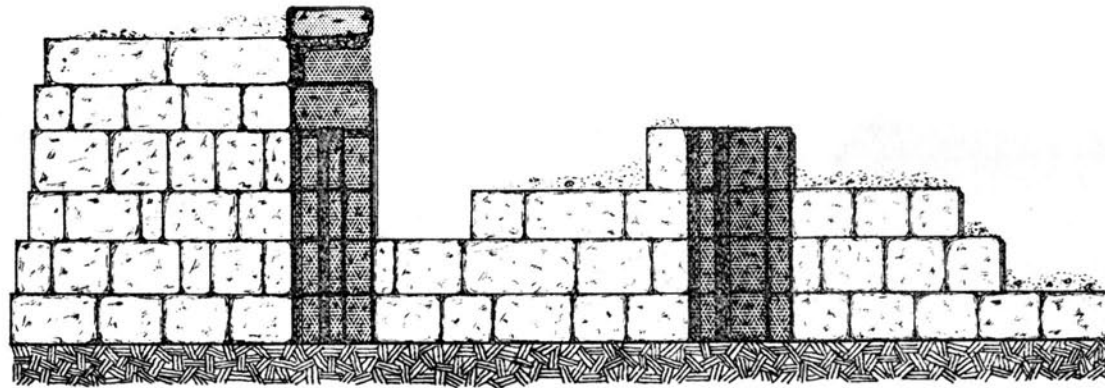


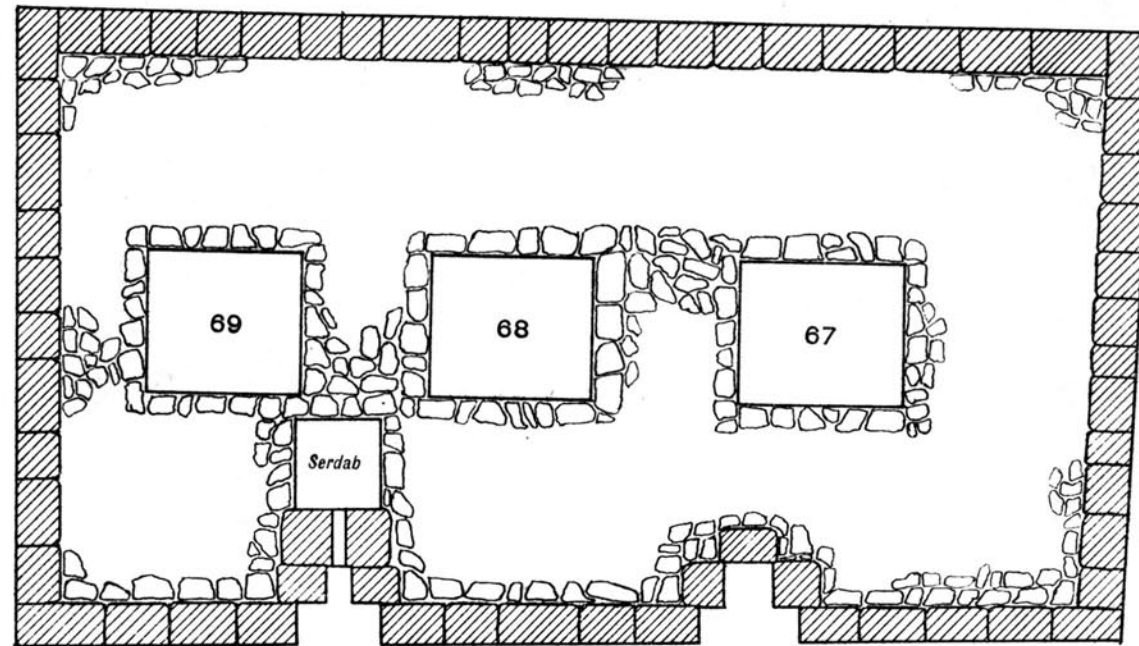
FIG. 70.—Part of vertebral column showing collapse of 10th and 12th vertebrae

To Professor Abu-Bakr I owe my deep respect and gratitude for all the facilities, which he willingly accorded towards examining this skeleton and presenting it to the anatomy department. My thanks also are due to Professor Assar for reading and correcting this note.

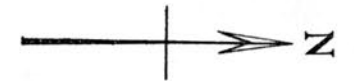
[This page is intentionally blank.]



West Elevation

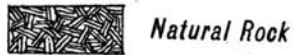


Plan

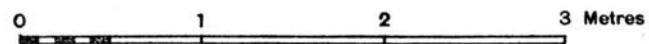


MASTABA OF
AKHW

REFERENCE



SCALE




Fawzy Ibrahim

FIG. 71

MASTABA OF 3HW


TITLE


 "The Overseer of the measurers".

To the west of Mastaba "D", there are two small limestone mastabas adjoining one another. There is no special importance in them, except that both give us some exceptional features (see General Plan).

The first one to the north is of a man called 3hw and has stepped superstructure (6.10 × 3.30 metres) built of small limestone blocks encasing a rough filling (Fig. 71).

There are two niches with false-doors on the eastern face. The southern one still has a lintel and a drum cut in one block.

The lintel has one line of hieroglyphs, running from right to left:  "Overseer . . . 3hw" (Fig. 72-A, Pls. XLV and XLVI-A).

On the drum:  "3hw" (Fig. 72-B).



FIG. 72-A

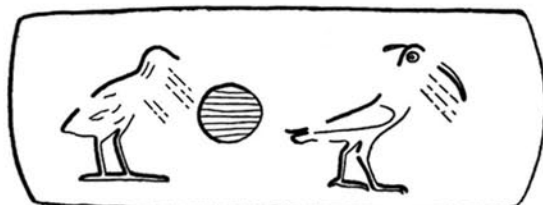


FIG. 72-B

The recess of the false-door is built in courses and plastered with thin layer of gypsum. At the top of it and behind the drum is a small vertical slit connected with the serdab, which is built behind the false-door and nearly in the axis of the slit (serdab: 0.50 × 0.50 × height 0.85 cm.). We had the luck of finding the serdab intact and containing the statues of 3hw and his wife Nfrt, with a small incense-pot of burned pottery with its lid in place, between the two statues and containing six pieces of charcoal (Pl. XLIX-B).

The serdab was roofed with three slabs of limestone and its walls were plastered with gypsum. In front and to the east of the southern false-door was a small uninscribed rectangular basin of limestone (20 × 18 cm.) (Pl. XLV).

The northern one is now partly destroyed and ought to have been dedicated to the wife Nfrt; because we found in the debris of the corridor two parts belonging to the northern false-door: (1) the upper lintel which is dedicated to 3hw, (Fig. 73-A, B); (2) the lower lintel

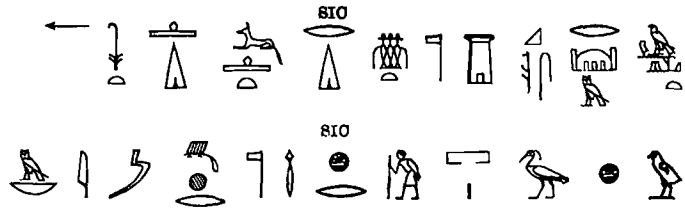
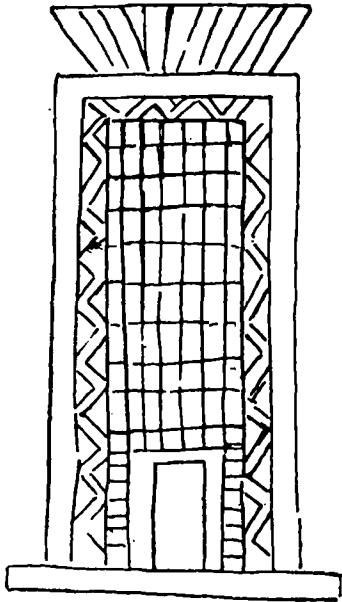


FIG. 73-A

0 5 cm

with the drum, both hewn in one block (Fig. 74, Pl. XLVI-B, C), whilst the lower lintel is dedicated to 3hw, we find the drum is written with the name of Nfrt.

The upper lintel is inscribed with one line of hieroglyphs, beautifully carved, which runs, from right to left, as follows:—



“May the King be favourable and give, may Anubis the foremost of the booth be favourable and give ⁽¹⁾, a burial in the west as possessor of honour with the great god and with the eldest of the house ⁽²⁾ *šhw* ⁽³⁾”.

FIG. 73-B.—Façade of shrine from the upper lintel of Akhw

The lower lintel and the drum are both hewn in one block and inscribed as follows (Fig. 74, Pl. XLVI-B):—

Lintel: “The overseer of the measurers (?) ⁽⁴⁾ *šhw*”.
 Drum: “His wife, Nfrt ⁽⁵⁾”.

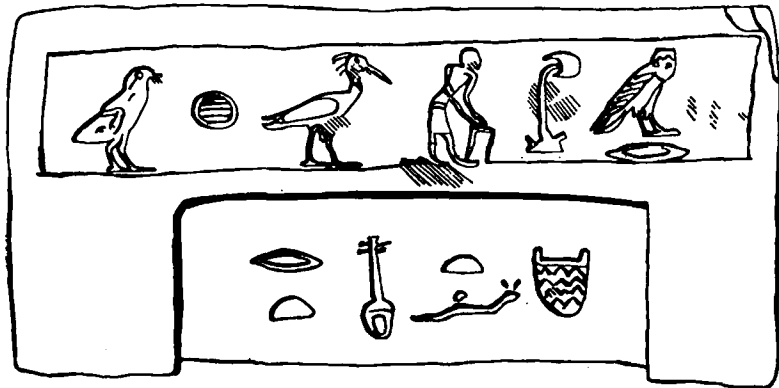


FIG. 74
 0 5 10 15 c.m.

⁽¹⁾ JUNKER, H., “Giza”, II, pp. 42-46.

⁽²⁾ The second may be a fault and in this case is the title of *šhw*. In the meantime, we know that *im im šhw* [*šhw-šr* may be connected with , , and , etc.; in our case he is *im šhw-šr-šmšw-pr*, cf. JUNKER, H, II, p. 55.

⁽³⁾ This name, written in this form, is unknown. The Berlin W.B., I, pp. 15, 16 speaks about “Bezeichnung bestimmter Dämonen”.

⁽⁴⁾ JUNKER, H., “Giza”, IX, p. 98.

⁽⁵⁾ RANKE, H., “Personennamen”, p. 201.

SHAFTS

This mastaba has three shafts (Fig. 75) :—

Shaft No. 67 : Unused burial-chamber and found empty ($0.90 \times 0.95 \times$ depth 3.00 metres and chamber : 1.30×1.60 metres).

Shaft No. 68 : Unused burial-chamber and found empty ($0.90 \times 0.95 \times$ depth 3.60 metres and chamber : 1.05×2.10 metres).

Shaft No. 69 : Unfinished small pit without burial-chamber ($0.90 \times 0.90 \times$ depth 1.60 metres).

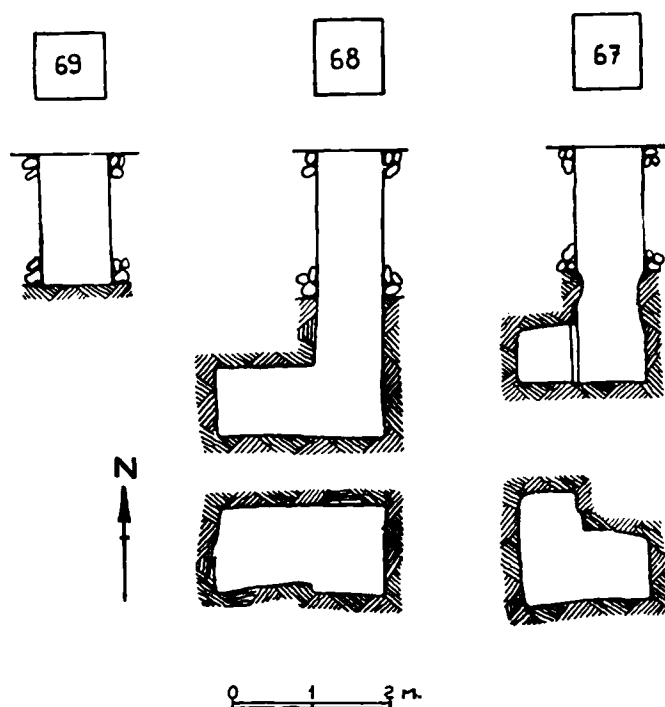


FIG. 75

THE STATUES OF *šhw* AND HIS WIFE *Nfrt*

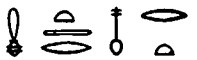
In the serdab, and buried in loose sand, we found the small statues of *šhw*, standing with his back leaning on the western wall of the cachet and gazing through the vertical slit, and that of his wife *Nfrt*, much smaller and placed on his left. Both retained most of their original bright colours (Pls. XLVII, XLVIII and XLIX-A).

The man is standing in the usual attitude, both arms hanging, with fists rounded about the symbolic kerchief. The basis is rectangular and rises at the back as a stela reaching to the level of the waist, connected also to a vertical partition wall left behind the left leg. He is clad in white skirt with *plissé*-work on the right triangular fold. He wears a broad necklace and a heavy black wig. The features of the face are peculiar and seem to show a successful attempt at portraiture. The large eyes widely gazing upwards, and heavily painted lids and eyebrows curved downwards towards the temples, the rather thin nose widening at the nostrils, the broad horizontal mouth with thick lips and finely shaped moustache, the round shape of the

face with high cheeks and pointed chin, all these features seem characteristic of a certain person. The modelling is detailed, although rather smoothed down to the conventional muscles. The beard is jutting somewhat forwards. This example illustrates the good workmanship of the capital at the end of the Vth Dynasty ⁽¹⁾ (Pls. I-A, B and LI).

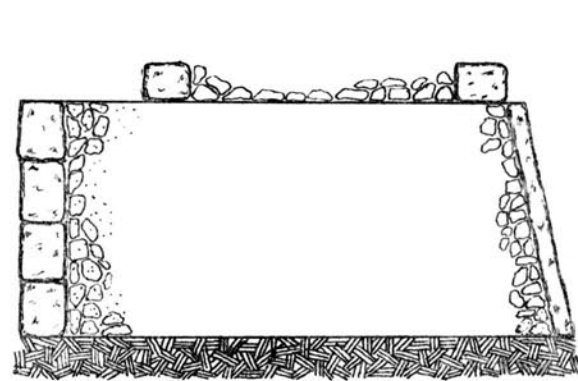
The statuette of the wife is of rather poorer quality, showing less realism and life. The attitude is conventional, the woman standing, both arms extended with hands open along the sides. Both feet rest side by side on a rectangular base, raising as a stela at the back. She is clad in long tunic hung on two broad braces in transparent *plissé*-stuff, over the breasts and shoulders. The main exceptional feature of this statuette is the way of representing the triangular bottom part of the basin, in detail, as if it were showing bare through a cut in the tunic. No reason can be proposed for such an accentuation of the sex of this woman.

The head is rather large firmly set on thick neck and wearing a small wig, with hair parted in the middle and showing the ears. The large eyes with large rounded iris and high drooping eyebrows, gaze in front of them in an expression of bewilderment. The nose is broadening at the base and the mouth is horizontally and widely cut with coarse lips. The general form of the face is square-shaped and the high cheeks and square chin together with the other features give an impression of a person of low extraction (Pl. LII).

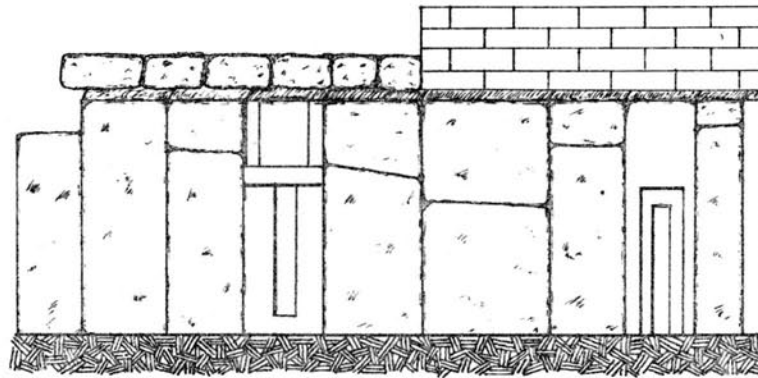
On the base of the statue and near the feet there is the following inscription : 

" Concubine, Nfrit ".

⁽¹⁾ cf. SMITH, W. S., "A History of Egyptian Sculpture and Painting in the Old Kingdom", 1946, p. 56, Pl. 22.

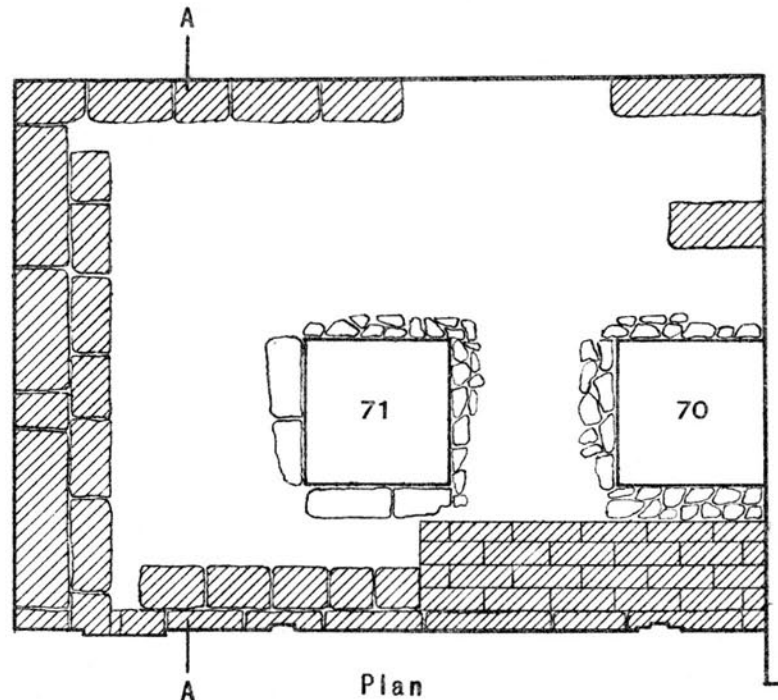


Section A-A



East Elevation


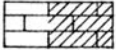


MASTABA - C



Plan



REFERENCE

-  *Natural Rock*
-  *Mud Brick*
-  *Stone*
-  *Gravel*

SCALE



Fawzy Ibrahim

FIG. 76

UNINSCRIBED MASTABA "C"

Adjoining the Mastaba of *shw*, on the south is this small uninscribed stone mastaba (see General Plan). The superstructure (4.20 × 3.12 metres) seems to have been originally of the stepped type with a rubble core, as is still visible on its western face, which is on the same line in plan as the western face of the Mastaba of *shw* (Fig. 76).

The southern face, however, was covered later with inclined casing of hammered blocks and connected at the south-eastern corner with an entrance whose two monolithic door-jambs are still in place. This entrance connects the corridor north-south between Mastaba "D" and this, with the passage to the south leading to another mastaba.

The eastern face has been lined with limestone slabs inclined and smoothed so as to imitate masonry of good limestone casing. This face has two false-doors indicated in low relief (Fig. 77). The southern one is larger than the northern and both of them are not inscribed (Pl. LIII).

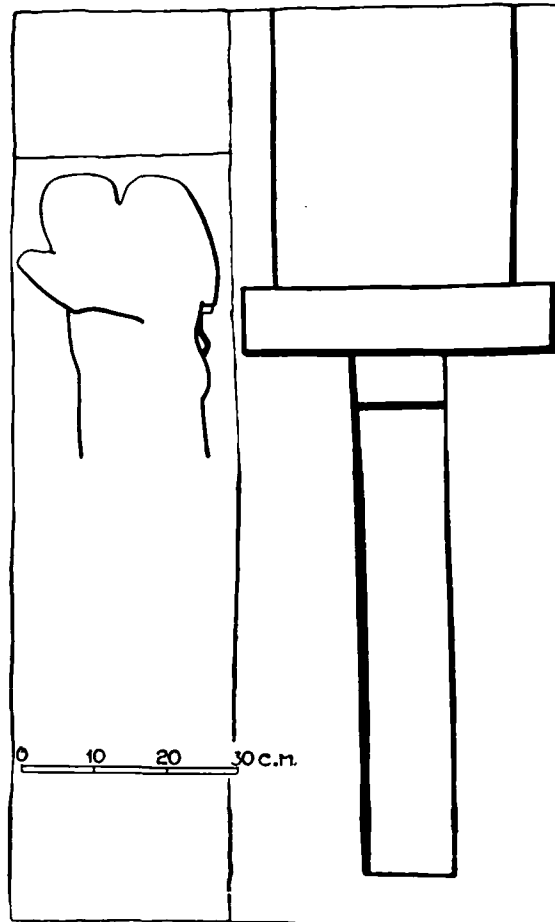


FIG. 77

At the southernmost part of the eastern face (the adjoining part of the wall), there is an unfinished low relief representing two persons, male and female, in the unusual posture of kissing each other. The relief is only indicated by one single contour-line cut with the chisel. The lower part of the scene is not indicated.

SHAFTS (Fig. 78)

Shaft No. 70: ($0.95 \times 0.95 \times$ depth 3.55 metres). Simple burial-chamber (1.20×1.90 metres), found empty and perhaps unused.

Shaft No. 71: ($0.90 \times 0.90 \times$ depth 4.10 metres). Burial-chamber (1.05×2.40 metres), found empty and robbed.

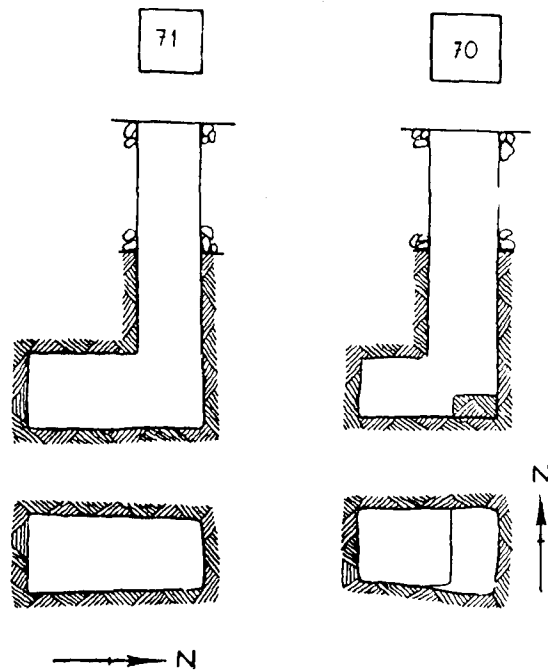
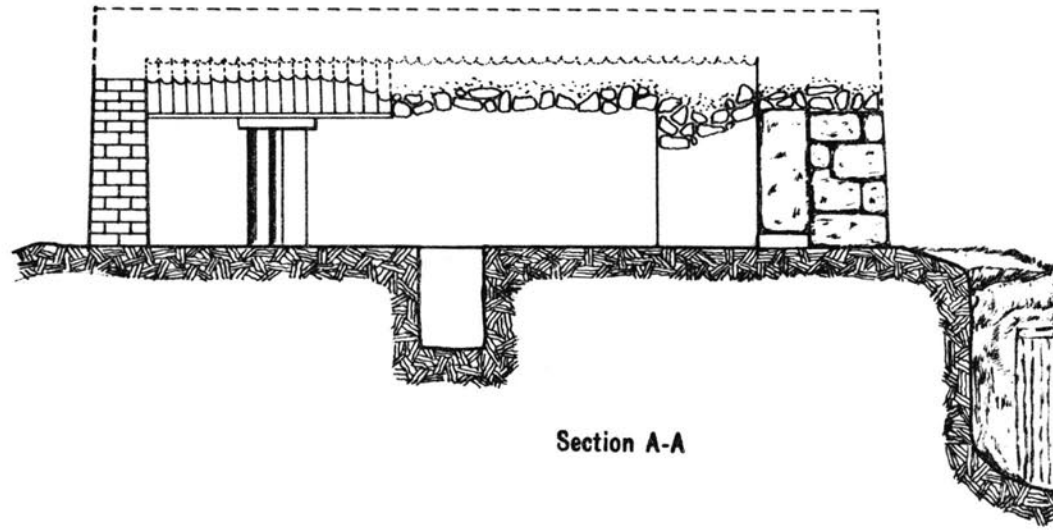
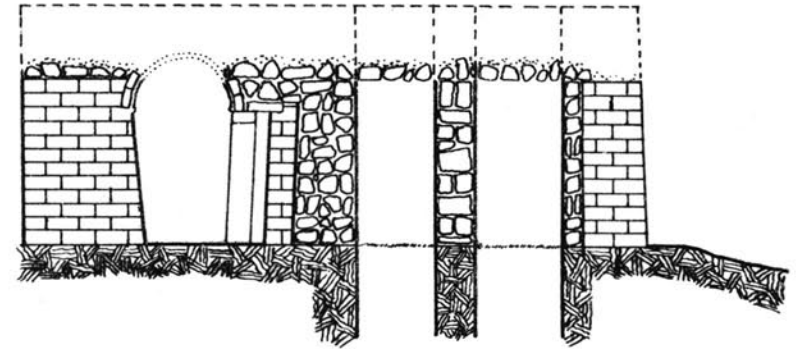


FIG. 78



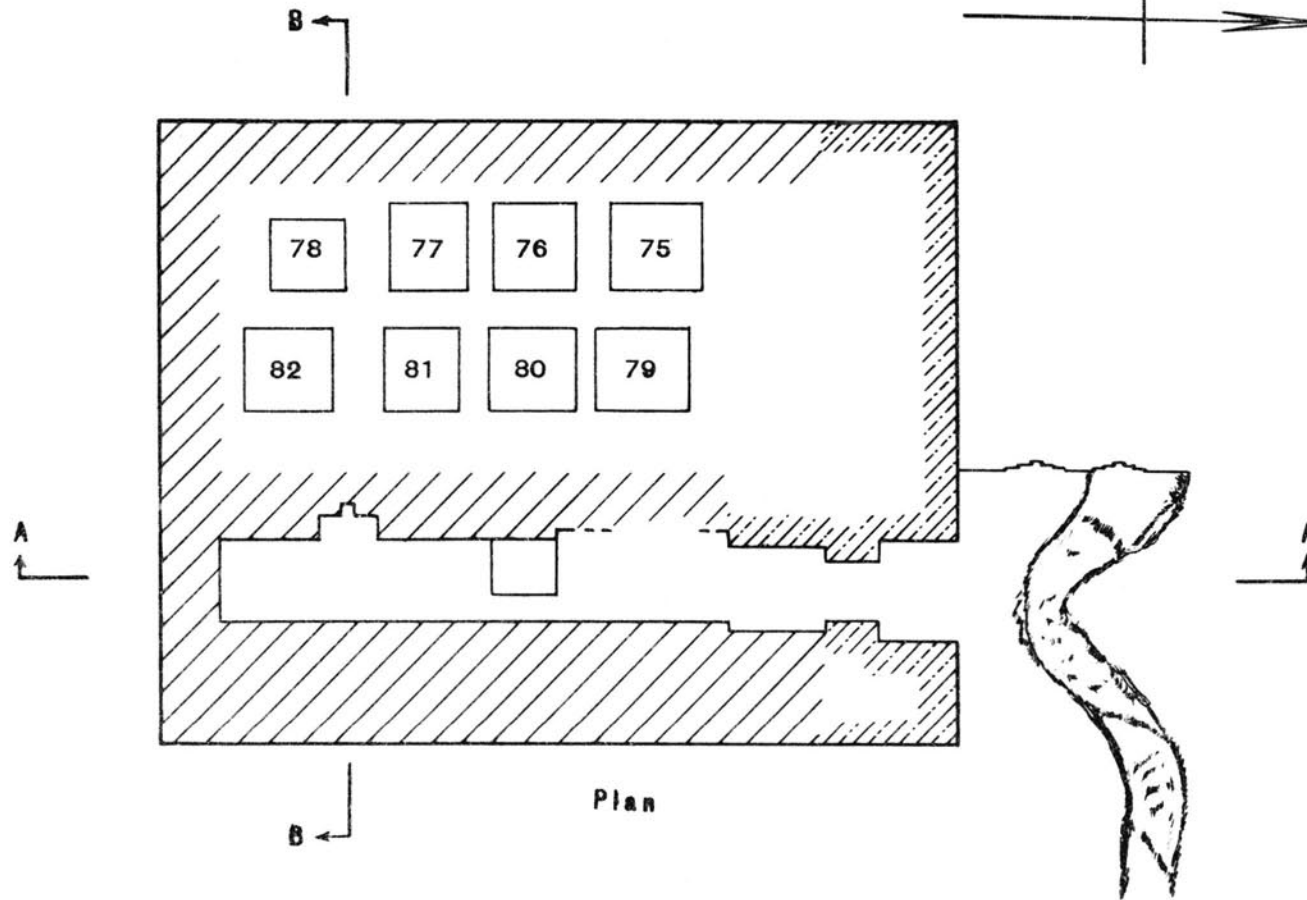
Section A-A



Section B-B







MASTABA D



Plan

REFERENCE

-  Mud Brick
-  Stone
-  Natural Rock
-  Gravel

Fawzy Ibrahim

FIG. 79

TOMB "D" WITH VAULTED CORRIDOR

Above the rock-tombs is another series of mastabas with superstructures on a higher level than the northern part of the district (*see* General Plan). The doors are facing north. Among them is a mastaba of small size. The superstructure is on a rectangular plan ($8.60 \times 6.70 \times$ height about 2.50 metres) (Fig. 79, Pl. LIV-A); its northern façade is in stone, whilst the remaining walls are in crude brick, reaching to the height of 2.50 metres. At the eastern end of the northern façade a recess is backed by the entrance door (68 cm. wide, 51 cm. deep) with monolithic limestone door-jambs. It opens at the northern end of a long and narrow corridor⁽¹⁾ directed north-west, the walls of which are in brick, daubed with mud and painted with a whitewash on rosy plaster. After 1.10 metres behind the door, the plan of the corridor is carried to the west for 13 cm. (left stone wall) and 18 cm. (right wall). The width at that point (95 cm.) increases farther to 1.16 metres but returns to the dimension 59 cm. at the middle of the corridor (6.78 metres in length). The left wall is vertical, the right one slightly baltering. At about 1.42 metres from the floor a horizontal rounded cornice, coloured red, runs along both walls. Out of these springs an Egyptian sacred vault with semi-circular ribs (Pl. LIV-B)⁽²⁾. These sprout almost vertically at the southern end of the corridor but their inclination increases as one goes farther towards the middle of the walls. The upper part of the vault has fallen and its springing is only preserved along the southern half of the corridor (20 ribs along the eastern wall). Each rib consists of two layers of bricks of special mould and is daubed with mud coated with plaster and red paint. Near the southern end of the corridor a false-door (65 cm. wide) is built in the western brick wall. It consists of a recess in which two wide door-jambs flank a second deep vertical cut. No drum or stone was found, apart from a rough lintel which probably was originally hidden behind the horizontal cornice.

A square shaft is hewn in the middle part of the corridor. Behind the western brick wall the rubble stone filling encloses 8 shafts in two parallel series (75, 76, 77, 78, 79, 80, 81 82). All are unfinished shafts and unused (Figs. 80 and 81).

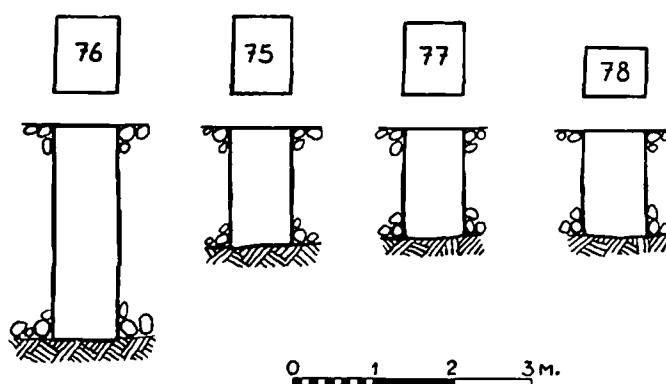


FIG. 80

⁽¹⁾ This is an exterior corridor-type chapel, *cf.* REISNER, G. A., "A History of the Giza Necropolis", Vol. I, p. 277, Figs. 168, 173.

⁽²⁾ *cf.* *infra* "Brick Vaults and Domes in the Giza Necropolis", Fig. 7, p. 4.

The bricks are of a small mould ($27 \times 13.5 \times 7$ cm.), set as courses of headers alternating with courses of stretchers. The vertical joints are thin but the horizontal ones sometimes reach to as much as 5 mm. The proportion of chipped straw in the mortar is low, although that of gravel and coarse sand is relatively high. The bricks contain chipped stone and potsherds.

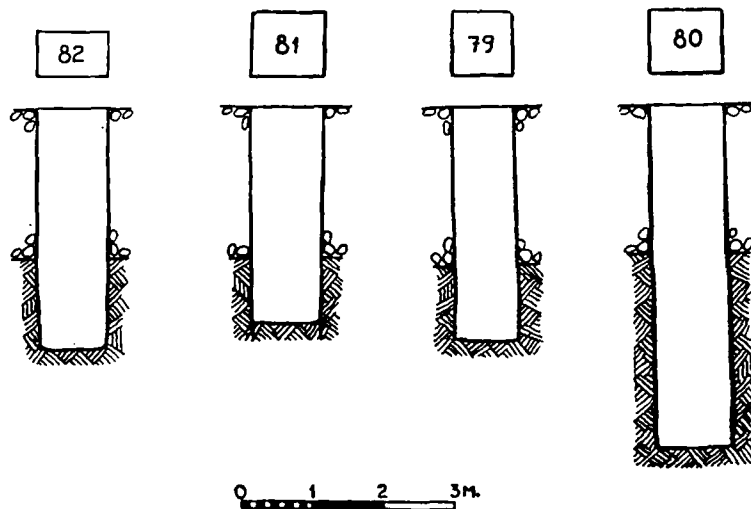
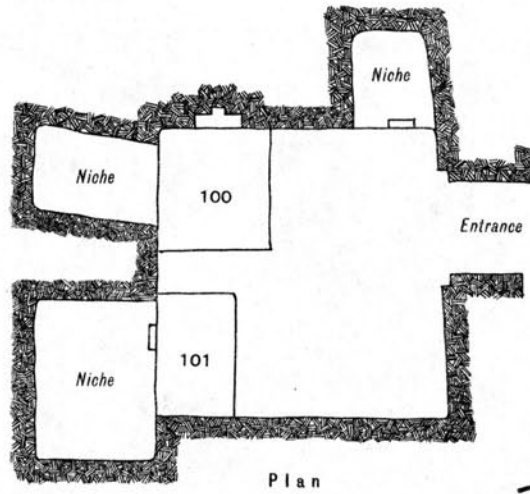
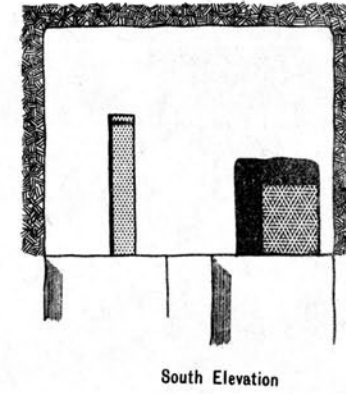
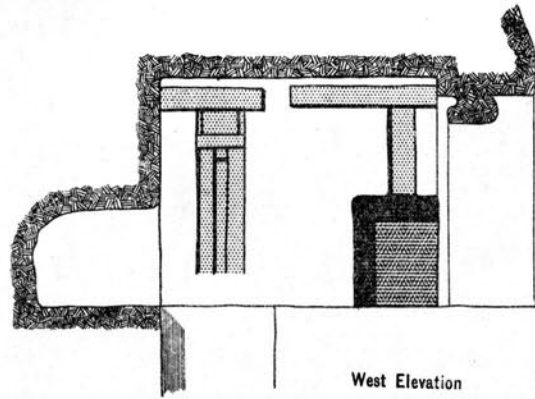


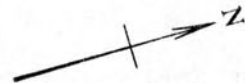
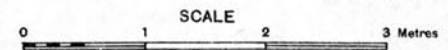
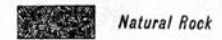
FIG. 81

The stones on the north façade are set in high courses (47-51 cm.), with only hammered faces of local nummulitic rock. There are level cuts in the faces of the recess.

ROCK TOMB OF ANKHW



REFERENCE

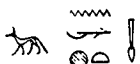



Fawzy Ibrahim

FIG. 82

ROCK-TOMB OF 'NHW


TITLES

1.  "Judge, powerful of voice".

2.  sh ?

In the same cliff and to the west of the Mastaba "D" and nearly underneath the Mastaba of *shw* (see General Plan) lies the Rock-Tomb of 'nhw with a small door opening (1.65 × 0.70 metres) leading to the chamber (Fig. 82).

Above the door opening is a drum hewn in the rock and inscribed (Fig. 83, Pl. LV):

→  "Judge, powerful of voice (1), sh (2) 'nhw (3)".

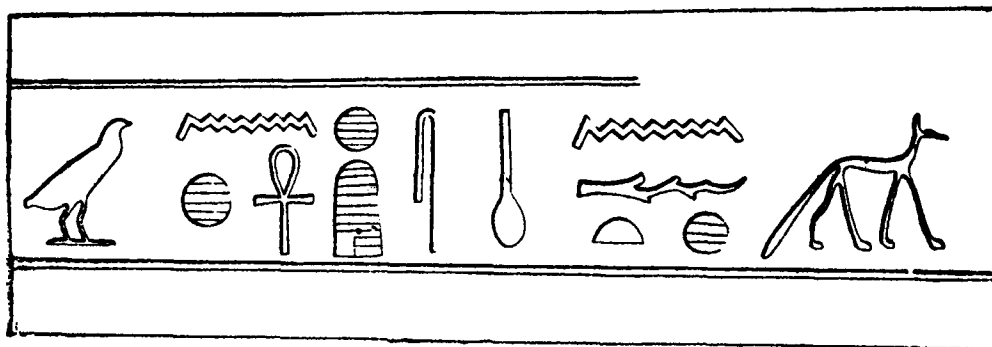





FIG. 83

 10 c.m.

The walls of the chamber (2.40 × 2.40 × height 1.95 metres) are roughly hammered, partly plastered with rosy gypsum and showing areas of red ochre dots. In the western wall are two false-doors, one only hammered out in part, with projecting lintels. A small cachet is hewn out under the unfinished false-door.

(1) This title was fully explained by "GRUNDELORF, B., " *Annales du Serv. Antiq.*", Tome, XLII, pp. 121, 122. He translates this title: (litt. "celui qui est fort de voix").

ensuite: (a) *Le préposé aux corvées,*
(b) *celui qui faisait travailler les serfs au jouet,*
(c) *celui qui dirigeait les corvéables.*

(2) The word  is difficult to join neither to the title nht-hrw nor to the name 'nhw. JUNKER (Giza, II, p. 169) explains it as a "granary". He says that the reading is unknown. In Giza, III, p. 82, JUNKER gives two variants with different pronunciations of the sign: (1) idnt , (2) . In our case there is no doubt that it reads sh.

(3) RANKE, H., " *Personennamen*", p. 68.

In the northern wall a plan was cut above the door-opening to provide for the wooden beam serving as lintel. In the southern wall a small recess plastered with gypsum and provided at the top with a rounded part; a drum was intended when finished as a false-door. Behind it is a small cachet in which we found a skeleton embedded in mud. In the western corner of the same wall, there is another small cachet which contained some loose bones.

In the floor of the room are two square openings, the eastern one (Shaft No. 100) (Fig. 84) being a false shallow pit, the other (Shaft 101) (Fig. 84) ($3.10 \times 1.00 \times 1.00$ metres) leads to a small burial cachet found closed by two courses of limestone blocks. It contained a skeleton embedded in mud.

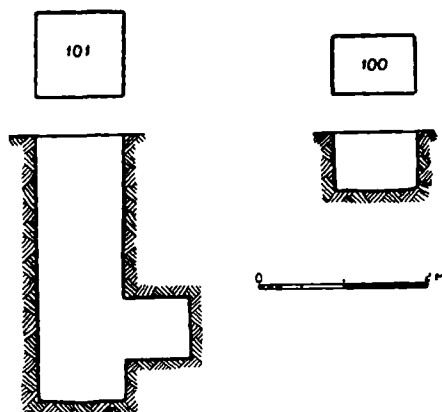
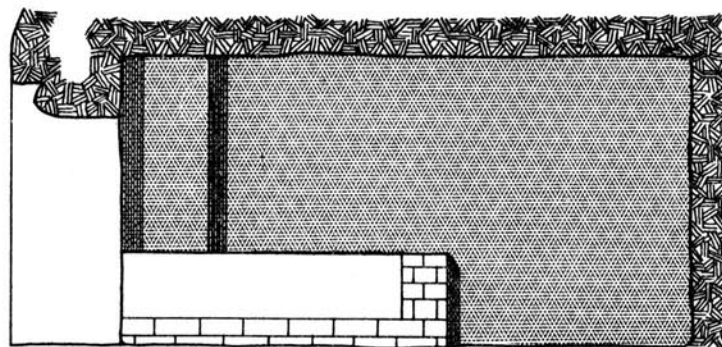
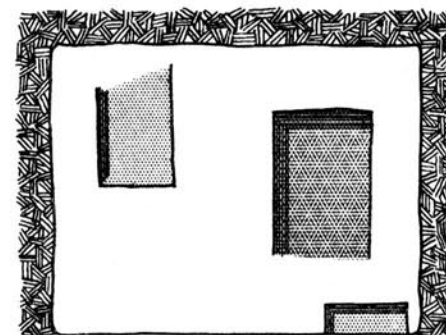


FIG. 84

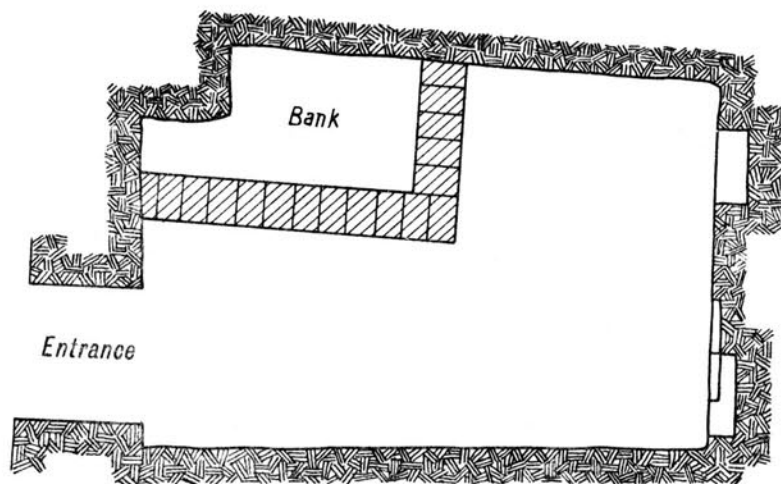
ROCK TOMB E



East Elevation



South Elevation



Plan

REFERENCE



Mud Brick



Natural Rock

SCALE



Fawzy Ibrahim

FIG. 85

ROCK-TOMB " E "

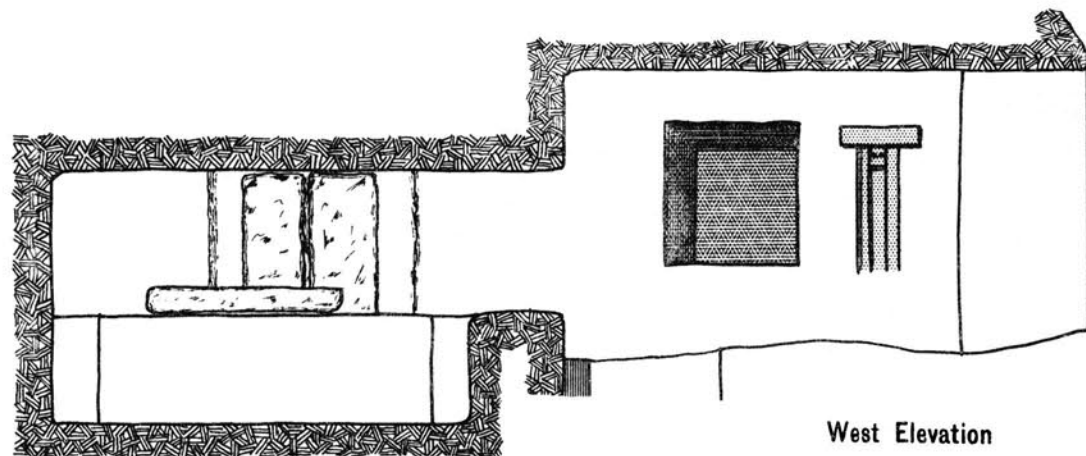
Between the Rock-Tomb of *'nhw* and that of *Nj-wd3-Pth*, there are three small rock-tombs which are marked as " E ", " F ", " G " (see General Plan). Burials were placed in square-shaped cachet like niches hewn in the walls (Fig. 85).

The entrance of the Rock-Tomb " E " measures 1.50 metres high \times 0.70 metre broad and 0.65 metre thick. It leads to a rectangular room, measuring $3.10 \times 2.10 \times$ height 1.60 metres. Attempts were tried to fill the breaks in the walls with yellowish mortar.

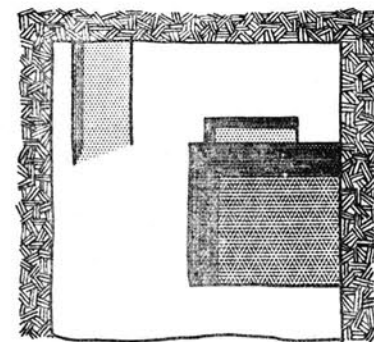
On the western wall a red-ochre line runs from the northern corner to the southern one on a height of 1.10 metres from the ground with a sign † marked, also in red near the northern corner.

The eastern part of this chapel is occupied by a rectangular bank (Pl. LVI-A) built of small stone blocks with mud mortar. The bank is smoothed from the outside with a thick mud layer and measures 0.50 metre high \times 1.50 metres long \times 1.00 metre broad. The bank was covering a small shaft, measuring $1.10 \times 1.00 \times 0.65$ metres, and contained a very primitive burial. The skeleton was dried and placed in the bottom of the pit in a contracted position. Nothing was found with the deceased (Pl. LVI-B).

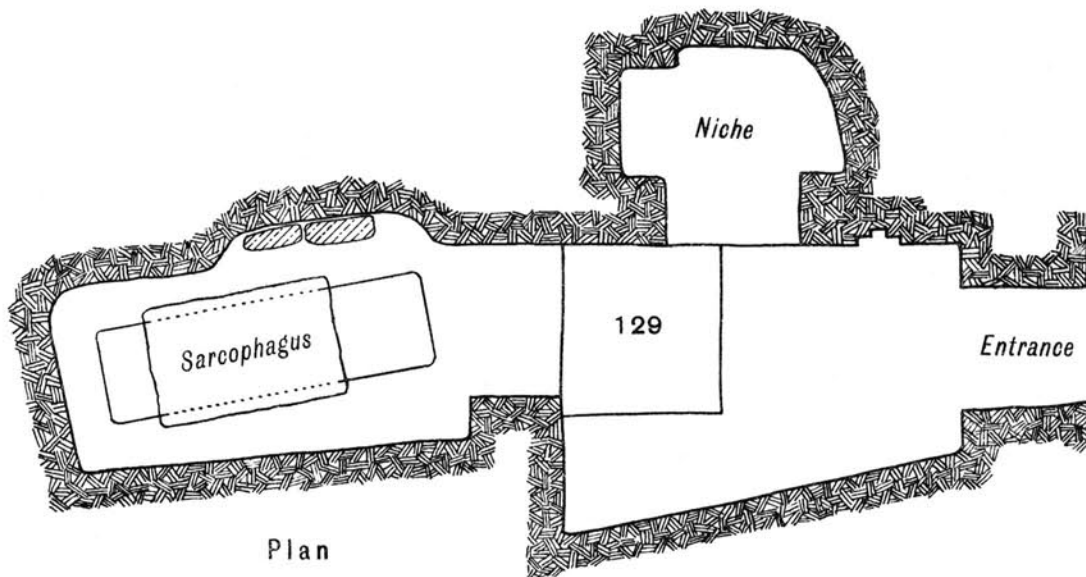
[This page is intentionally blank.]



West Elevation

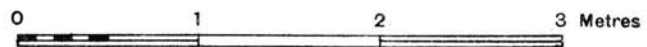


South Elevation



Plan

SCALE



ROCK TOMB F



REFERENCE



Stone



Natural Rock

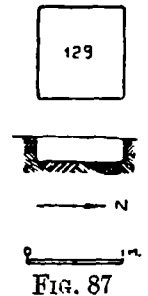
Fawzy Ibrahim

ROCK-TOMB "F"

This rock-tomb is situated to the east of Rock-Tomb "E" (*see* General Plan). Its entrance measures 1.60 metres high \times 0.60 metre broad \times 0.60 metre thick and leads to the small chapel, which measures 2.20 \times 1.30 \times height 1.60 metres. This chapel is roughly hewn in the rock with still unfinished parts (Fig. 86).

An attempt to dig a shaft (No. 129) (Fig. 87) was done in the southern part of the chapel but its mouth does not go deeper than 20 cm.

A small niche, measuring from inside 1.20 \times 0.65 metres, is sunk in the western wall on a height of 50 cm. from the ground. To the north of this niche, an unfinished false-door is cut in the rock.

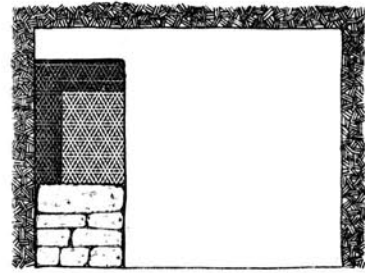


In the southern wall an opening (85 \times 85 cm.) leads to a long cachet (2.80 \times 1.00 \times height 0.85 metres) running north-south. In its ground is sunk a big recess (1.90 \times 0.50 \times depth 0.60 metres) serving as a sarcophagus. A big slab of limestone with curved outer face was used as a lid. In the sarcophagus a very damaged skeleton was found in no apparent order.

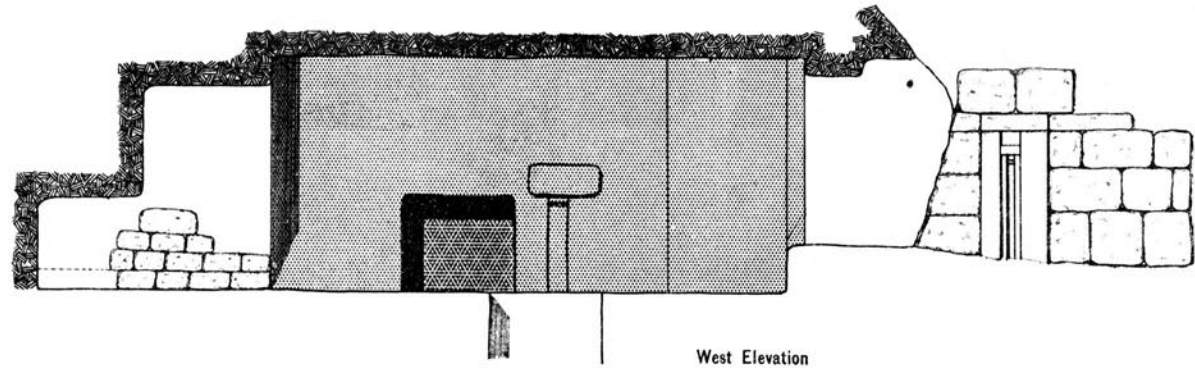
The eastern wall is unfinished and does not give any trace for a false-door.

[This page is intentionally blank.]

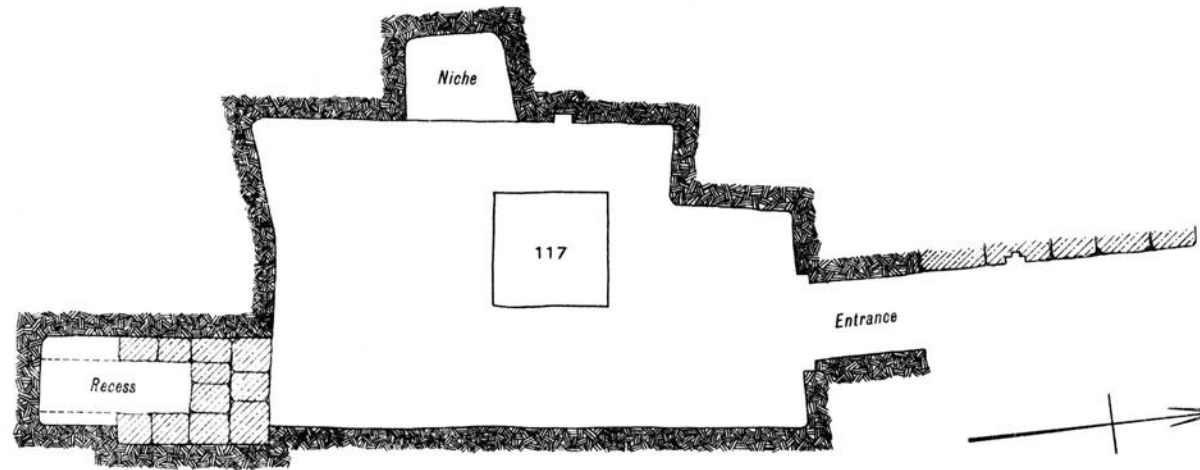
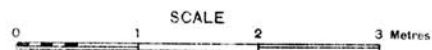
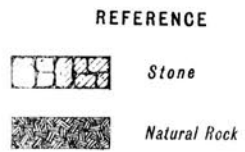
ROCK TOMB G



South Elevation



West Elevation



Plan



Fawzy Ibrahim

FIG. 88

ROCK-TOMB " G "

This rock-tomb is situated to the east of Rock-Tomb " F " and to the west of that of *Nj-wd 3-Pth* (see General Plan). The access to its entrance is bordered on its western side with a nearly rectangular building having on its eastern face a limestone unscribed false-door.

The entrance measures 1.50 metres high \times 0.60 metre broad (Fig. 88).

The chapel is very roughly hewn and is rectangular in plan and measures 4.10 \times 2.50 \times height 1.90 metres.

An unfinished shaft (No. 117) (Fig. 89) is dug in the middle of the chapel.

In the western wall there is an attempt to carve a false-door and to the south of it a small cachet, which measures 70 \times 90 \times height 90 cm. and does not contain any trace of burial.

The southern wall contains a recess (1.90 \times 0.90 \times 0.80 metres) built to a part with small slabs and hidden in a small cachet sunk in the wall. The cachet measures 1.75 metres high \times 0.90 metre broad \times 1.90 metres deep. Also in this recess no traces of burial were found.

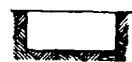
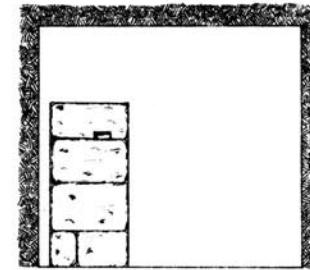
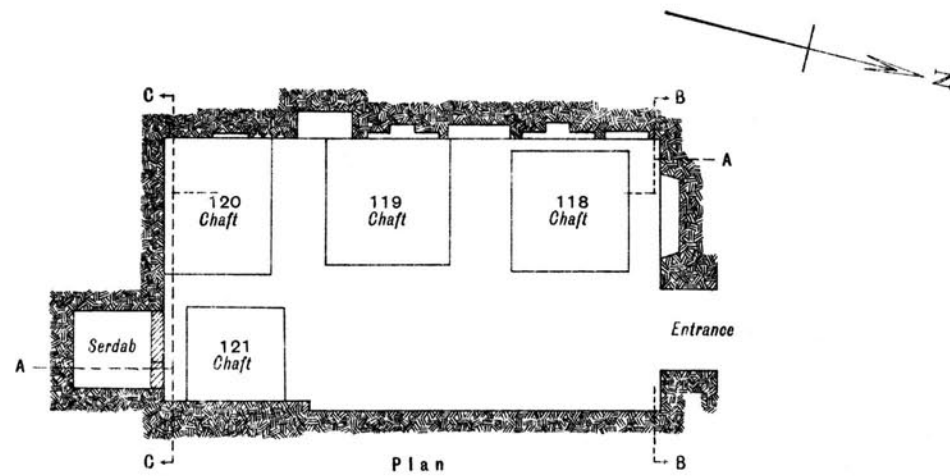
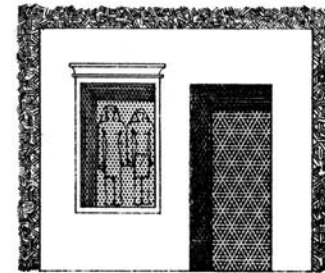
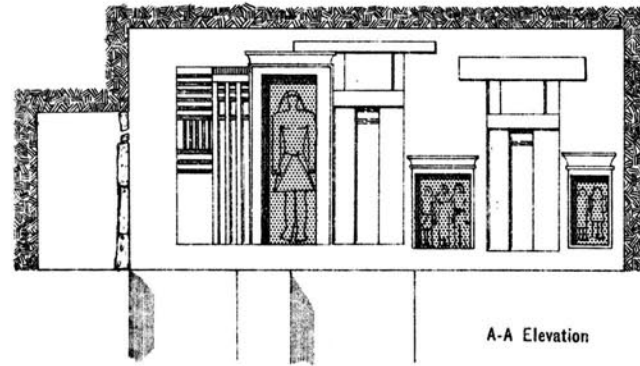


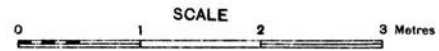
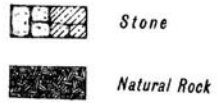
FIG. 89

[This page is intentionally blank.]

ROCK TOMB OF NI-WDA-PTAH



REFERENCE







Fawzy Ibrahim

FIG. 90

ROCK-TOMB OF NJ-WD3-PTH


TITLES


1.  "Ka-Priest".
2.  "Overseer of the Ka-Priests".
3.  "Possessor of Honour with the Great God".
4.  "Overseer of the House".

DESCRIPTION

This is the most important tomb of this group and is situated in the middle of the row (see General Plan). It can be compared with examples of type RC (IV): NS-hall, or corridor with entrance from the north ⁽¹⁾ (Fig. 90).

Access to it is gained through a small door (1.74 × 0.62 metres) opening in the dressed northern face of the cliff. Above the line, which the upper side of the lintel would have determined, if it were a built-up door, a vertical stone slab was fixed to the rock with mortar. It shows the deceased standing facing right, dressed in a pointed kilt, his left hand holding the long staff vertically along the axis of the figure and in the right hand he holds the *hrp*-sceptre (Fig. 91, Pl. LVII-A) ⁽²⁾. Above his head the following hieroglyphs are inscribed:

 "Overseer of the Ka-priests, *Nj-wd3-Pth* ⁽³⁾".

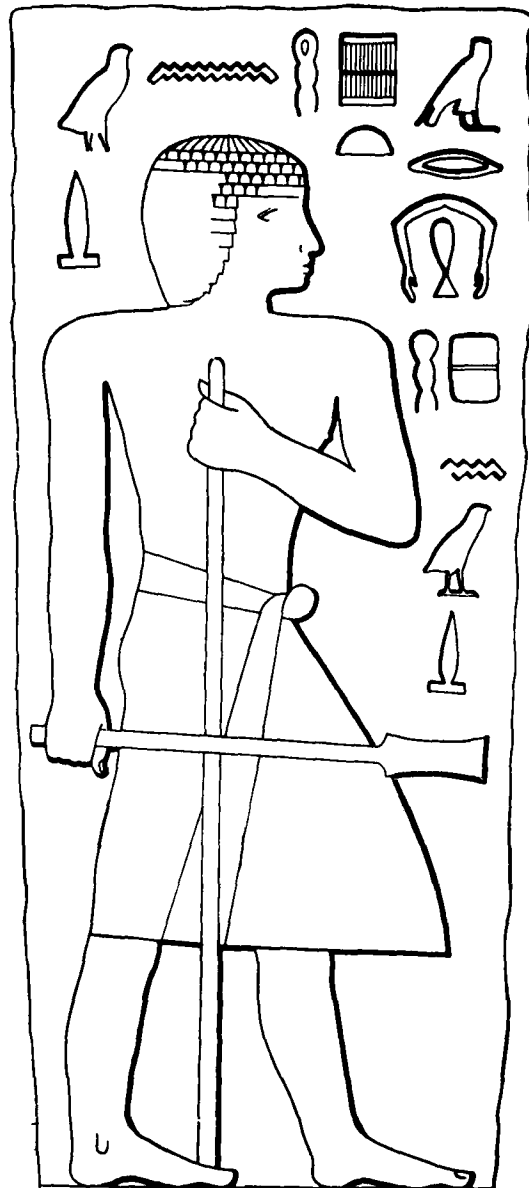
Beneath the horizontal edge of the door-opening, a drum, cut in a separate block, is inserted and inscribed with beautiful hieroglyphs in low relief, giving the name and titles of the deceased:  "Overseer of the Ka-priests, possessor of honour with the great god, *Nj-wd3-Pth*" (Fig. 92).

The door opens at the north-eastern corner of the chamber which is entirely hollowed out of the rock (4.20 × 2.28 metres). The inscriptions are also hammered into the rock about 2 mm. high and bear the traces of the tools used. Veins of weaker rock caused a

⁽¹⁾ REISNER, G. A., "A History of the Giza Necropolis", Vol. I, p. 241, Figs. 146, 147.

⁽²⁾ This characteristic view occurs already on one of *Hsj-R'* panels, on "the false-door of *Nfr-Sim* (Brussels) and on the entrance jambs of G. 7750 (cf. SMITH, N. S., "A History of Egyptian Sculpture and Painting in the Old Kingdom", 1941, pp. 277-8, Fig. 117). It occurs also in our Necropolis on the back panel and the left jamb of the false-door of *Ni-htp-hnmw*.

⁽³⁾ *Nj-wd3-Pth* "Possessor of health is *Ptaḥ*" (cf. RANKE, H., "Personennamen", I, p. 172.



0 5 10 15 c.m.

FIG. 91

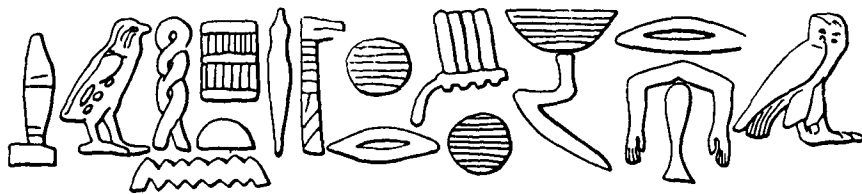


FIG. 92

0 5 10 15 c.m.

settlement in ancient times, probably during the dressing and they were patched with rosy plaster of the same quality as that which appears on the eastern and southern walls. Along the western side of the chamber three shafts opening in the floor Nos. 118, 119, 120 were found empty. A fourth unfinished shaft No. 121 is cut into the floor at the back of the chamber (Fig. 93).

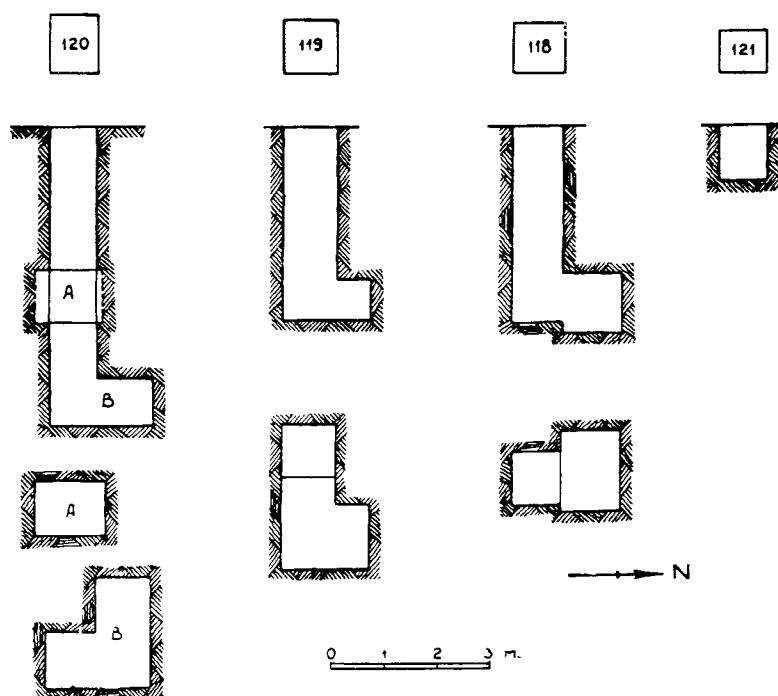
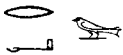


FIG. 93

In the back wall and above the unfinished shaft a cachet (height 1.30 × width 0.57 × depth 0.58 metres) was hollowed out of the rock to serve as a serdab for two statues (Pl. LVIII-C). It was closed up by 4 slabs of stone, laid horizontally one above the other. Along the horizontal joint between the upper slab and the one below it a slit (13 × 3 cm.) opens at the level of the head of the bigger statue, while another smaller slit (7 × 3 cm.) opens vertically lower to the left, in the third slab, and was in front of the face of the smaller statue (Pl. LVIII-A).

When we opened the serdab we found these two statues. On the left hand was a white limestone statue of the eldest son  *Wr-R'* (height 52 cm., width of the breast 14 cm., base length 23 cm., width 12 cm., height 5½ cm.). The colours are partly preserved. It represents *Wr-R'* in the walking attitude, both arms hanging down by the sides with fists clenched round the conventional filling. The features of the face are regular. He wears a short wig of the graded type and around the neck is a coloured necklace which is turned white. Around the waist is a short kilt with a triangular *plissé*-work on the right side. The muscles of the arms are rounded and unimportant, while those of the legs have been rendered mechanically in straight planes which do not correspond to the realistic featuring as one remarks, for example, in the panel at the northern end of the western wall (Pl. LIX-A, B).

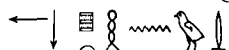
On the right hand a small statuette, of white limestone, was found, representing a woman-servant in the usual position for grinding corn (height 22 cm., length 26 cm.). It does not retain its original colours, except the black hair which appears from beneath the kerchief covering her head. The grinding-stone is coloured red with black posts; these two colours are representing red granite. The features are those of a commoner and are rendered in rough strokes. The handling of muscles is also, by means of plain, striping in the arms and legs (Pl. LX).

This statuette was found lying on its left side, buried in a heap of wooden debris and powder, which very likely were the remains of a decayed wooden statue representing *Nj-wd3-Pth* himself. To judge by the level of the higher slit in the serdab facing, which was presumably intended to serve as an opening in front of the face of this statue, its height would have reached to a little over one metre.

THE NORTHERN WALL

To the west of the door-opening, a group in high relief stands in a rectangular niche (height 1.11 × width 0.65 metres) recessed in the wall about 48 cm. above ground-level. A frame slightly protruding and about 9 cm. wide surrounds the recess. It is topped with cornice and torus (Pl. LXI-A). The two statues represent two men identical in stature, standing, with the legs on one line, slightly apart. The arms hang down by the sides and the hands close around the usual unidentified rounded butt. They are both dressed in the short kilt fastened by a belt and showing the triangular *plissé*-position on the right side. They wear a stripped wig reaching to the shoulders. The face of the right-hand man is finely treated, with regular features showing a beautiful flat-shaped specimen of the Old-Kingdom type. The eyes are wide and drawn in black ink over the sculpture. The face of the left-hand man is somewhat longer in size and less refined. It stands on a thicker neck, although the statue, most probably represents the same person (1).

THE EASTERN WALL

Near the corner of the door-opening a sculpture is cut in low relief. It begins just below the ceiling-line (17 cm.), is about 1.23 metres in height and stops 63 cm. above floor-level. It shows the owner of the tomb, together with his wife, facing curiously enough the interior of the chamber. *Nj-wd3-Pth* is represented in a walking attitude dressed in a long point kilt. His right hand holds horizontally the *hrp*-sceptre, and the left hand the long staff, rounded at the top. The face is finely worked and shows the characteristic features of the Old-Kingdom type: large eyes, long rounded nose and wide mouth with a protruding heavy upper lip. He wears a striped wig hiding the ears and reaching to the shoulders (Pl. LVII-B). His name is written in front of his face: ← ↓  *Nj-wd3-Pth*.

(1) cf. SMITH, W. S., "A History of Egyptian Sculpture and Painting in the Old Kingdom", Pl. 216.




Behind him, his wife stands dressed in a long robe. Her right hand is extended towards the right forearm of *Nj-wdꜣ-Pth*, the left one is rounded about his left shoulder. The face also shows features characteristic of the same type as her husband. She wears a long wig, leaving the ears free, and with its foreparts hanging down on the breast. Her name is written in front of her face:  (¹), *Kꜣ-j-m-nht* (Fig. 94).





FIG. 94

In the lower part of the scene, three small figures—those of the owner's sons—are shown in slight "relief en creux". The first, standing in front of his father and on the same ground-level, represents his eldest son in a walking attitude. His right arm hangs down with the fist closed, his left is put on his breast and the right leg is partly behind his father's left]foot. He wears no wig. His name is written behind him:  (²) *Wr-R'*.

(¹) RANKE, H., "op. cit.", p. 339, cf.  *Kꜣ.j.m.ꜣht*.

(²) RANKE, H., "Die Aegyptischen Personennamen", S 217, is read *R'.Wr* "Es ist gross".


The second figure is smaller and appears between the legs of *Nj-wd3-Pth* and the lower border of his kilt. He stands on the same ground level. The attitude is similar to that of the former one but the left arm is held up behind the left leg of the father. Behind him his name is inscribed :  *Rdi-Pth* (1).

The third figure is of the same size as the second but stands on a higher level between the father's right leg and the mother. His left arm is raised so that the hand rests on the right leg of *Nj-wd3-Pth*. His name is written above his head :  *Ni-hpt-Pth* (2).

The remaining area of this wall is left bare with elongated portions patched up with rosy plaster. Near the sculptured scene and at a lower level is a rectangular frame sketched in red ink. It consists of two horizontal lines above a framework of horizontal lines intersected by vertical ones. Could it be the preparatory sketch of a palace-façade ?

THE WESTERN WALL

It is the richest of all since it is wholly covered with no less than three false-doors, three statue-niches and two sculptured scenes. These seem at first glance to be set at random, but are in reality ruled by a certain composition. The wall is divided up into six sections, three false-doors alternating with three statue-niches.

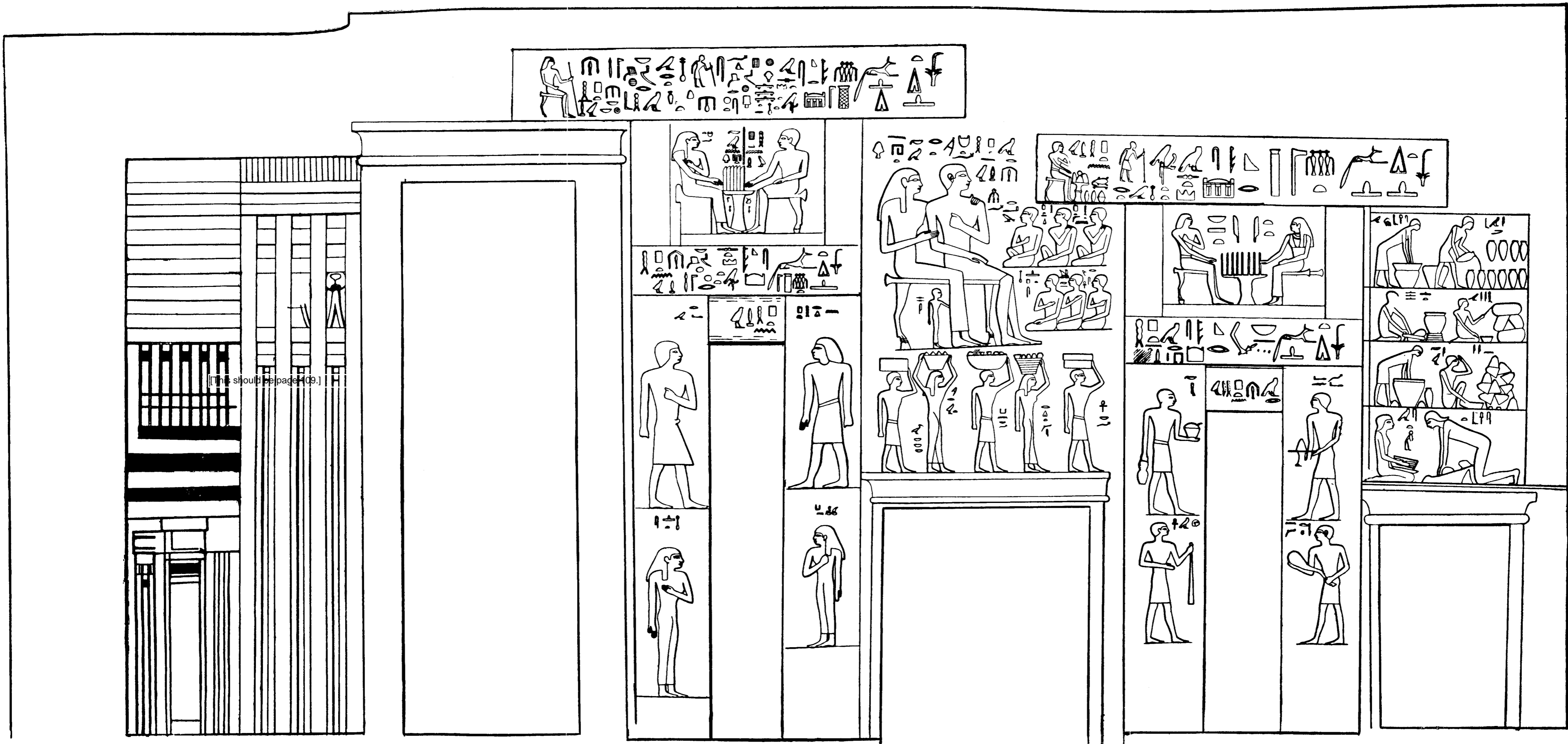
At the southern end of the wall, a false-door of the palace-façade type occupies nearly the whole height of the wall. Its sculpture was only partly finished and the rest (middle recess and right-hand jamb) is only in the form of drawings in red ochre. The left-hand jamb is quite bare. The outline of the middle recess shows the usual elements : small door at the bottom surmounted by the horizontal lines and the vertical niche-work pattern. At the top, however, there appears the unusual feature of six horizontal protruding bars, the two highest ones being carried over the right-hand jamb. This consists of three recessed niches, each surmounted by the  decoration and topped by the cornice with vertical elements (Pl. LXII-A).

The niche adjoining this palace-façade door to the north is slightly larger in height, topped with a cornice and surrounded by a frame (Fig. 95-A, Pl. LXII-B).

It is deeply recessed and contains the statue of a man standing with feet slightly apart. Both arms are hanging down along the sides, the fists closed round the usual butt-shaped object. He is dressed in a wide kilt with a triangular projecting apron-front fortunately a belt with a looped end. He wears a striped wig coloured black and hiding the upper parts of the ears. The features of the face are fine though not accentuated in the relief. The eyes are drawn in red, the upper lids are black. A line is still visible accentuating the edges of a collar. The workmanship, in general, is not of the first class, the left shoulder being higher than the right one.

(1) RANKE, H., *op. cit.*, S. 228.

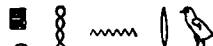
(2) RANKE, H., *op. cit.*, S. 173.




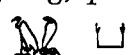
[This should be page 109.]


Fig. 95-A


[This page is intentionally blank.]

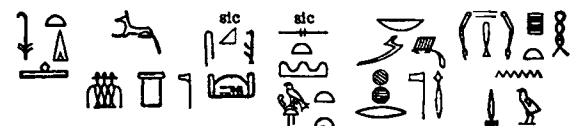
The second false-door is adjacent to this niche and to the north of it. It is of the simple type with a central recess flanked by jambs and surmounted by an offering scene between both lintels. The central recess is left bare, the rock having nearly been hammered out. The drum above it bears the name of the owner:  *Nj-wd₃-Pth*.

The right-hand jamb shows two figures in two registers, carved in low relief and facing the central recess. The upper one is that of a man in a walking attitude, wearing a short kilt and a long wig, both arms hanging down, the left hand closed, the right one open. Traces of the red outline are still to be seen on the wig. His name is written above his head:  *Rdi-n-Pth*⁽¹⁾ (Fig. 95-B, Pl. LXIV).

On the lower register, drawn to a smaller scale, a woman stands dressed in a long robe, her left arm with open hand hanging down, her right one with open hand bent over the breast. She wears a long wig, part of which hangs in front over her breast. Her name is written above her head:  *K3(j)-nj-nb.tj*⁽²⁾ (Fig. 95-B, Pl. LXIV).

On the left-hand jamb we find similarly two registers, the upper one showing a man walking, his right arm with closed fist hanging down, his left arm with closed fist bent over his breast. He wears a large triangular kilt with looped belt and a short round wig. Traces of black paint are still to be seen under his chin. The name is written above him:  *Wr-R*.

In the lower register stands a woman in the same attitude as the one facing her on the other jamb, but drawn to the normal scale; her name is given as:  *Nfr-htp-s*⁽³⁾.

The lintel is inscribed with the following text: 

“May the King be favourable and grant, may Anubis the foremost of the divine booth be favourable and grant a burial, (in) the west desert, (as) possessor of honour with the great god, (to) the overseer of the *Ka*-priests, *Nj-wd₃-Pth*” (Fig. 95-B, Pl. LXIV).

Above this lintel is the square tablet with a scene in low relief showing the owner and his wife seated opposite each other at a meal. Curiously enough *Nj-wd₃-Pth*, is shown seated to the right of the table instead of the usual way of representing the owner of the tomb sitting on the left side (of the offering-table). He is seated on a settee facing the table, dressed in a short kilt, his head bare, his right arm extended towards the offering-table where two of the vertically indicated loaves are missing, having probably already been eaten⁽⁴⁾. The left arm rests upon his left thigh, the hand, however, is wrongly depicted as a right hand. Only the back legs of

(1) RANKE, H., *op. cit.*, p. 228, “*Ptah gibt mir*”.

(2) RANKE, H., *op. cit.*, p. 340, “*mein K3 ist der des nb. tj*”

(3) RANKE, H., *op. cit.*, p. 198, “*Schon ist ihre Gnade*”.

(4) See below p. 9.

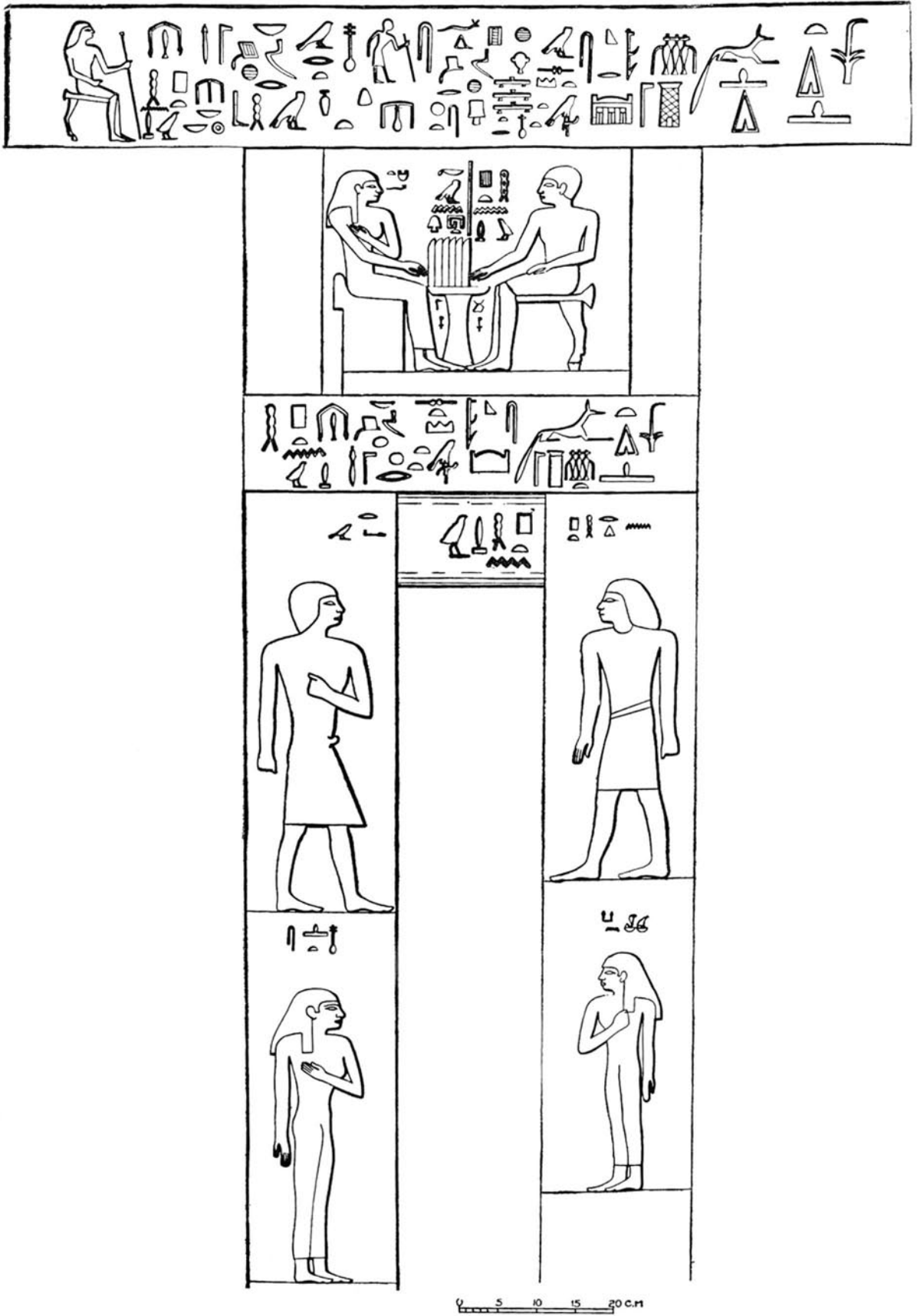
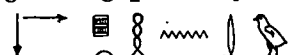
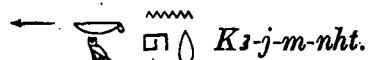
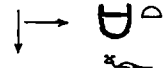
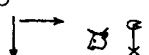



FIG. 95-B

the settee are shown, the front legs being probably hidden behind the man's legs. His name is written in front of his face:  Nj-wd₃-Pth.

On the left side his wife sits upon a massive chair, dressed in a long robe and wearing a long wig, the ear showing and part of the hair hanging down on her breast. Her right arm is extended towards the table, where the four loaves on her side are still in place, while the left arm is bent over the breast, with the outstretched hand correctly shown (1). In front of her face is her name:  Ks-j-m-nht.

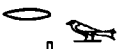
Above her head we find the word [her title]:  "his wife", which is lacking in the large scene beside the entrance-door. Under the offering-table and on the right of the stand:  and on the left: .

The upper lintel is relatively long and extends from both sides, over half of the scene to the right and the statue-niche to the left. The inscriptions are incised in disorder and there are even some words missing. The lintel ends on the left hand with a small scale representation of Nj-wd₃-Pth seated on a settee, with short kilt and long wig, with the right arm extending over his lap, and the left hand holding the long staff. Here again only the back legs of the settee are showing.

The inscriptions are as follows: 

"May the King be favourable and grant, may Anubis the foremost of the divine booth be favourable and grant a burial in the western cemetery and that he [may] walk on the beautiful ways upon which the honoured ones (walk), (after) a very good old age, and that offerings may come forth at every festival and every day (to him) as possessor of honour with the great god, to the Ka-priest, Nj-wd₃-Pth" (Fig. 95-B, Pl. LXIV).

THE SCENE AND THE SECOND STATUE-NICHE (Fig. 95-C, D, E, F)

To the north of the above-mentioned false-door a vertical strip of the wall is occupied at its bottom by a statue-niche which is surmounted by a scene divided into two registers. In front of it an earthenware stand was found in situ and a small offering-table was recessed in the ground with the name of  Wr-R (Fig. 95-G, Pl. LVIII-B).

The niche (Pl. LXI-B) is square-shaped and rather small, with a frame in red paint, topped with a torus carved in the face of the rock and a cornice partly hollowed and partly painted in

(1) This realistic feature intends to convey to the mind the idea of action and is known from other examples: of G. 1227, G. 4710, REISNER, G., "A History of Giza Necropolis", Vol. I, Pl. 20, 75. In one case the place has been cleared of loaves to show a trussed goose (SMITH, W. S., "A History of Egyptian Sculpture and Painting in the Old Kingdom", Pl. 45 b). That the clearance was to allow the outstretched hand to be shown distinctly is not the real reason, since the hand is sometimes shown over the loaves (JUNKER, H., "Giza", IX, Abb. 26).

red. Three standing statues are carved in weak high-relief. To the right is a man with short kilt, partly in *plissé-work*, both arms hanging down by his sides and fists clenched round the protruding butt, and wearing a short wig. The features of the face are regular, similar to those of the statues in the niche by the door or that in the large niche, the nose rather wide. To his right, stands a woman of nearly the same statue, with a long robe, long wig, her left arm hidden behind the man, with only the hand appearing round his left side ⁽¹⁾ and her right arm

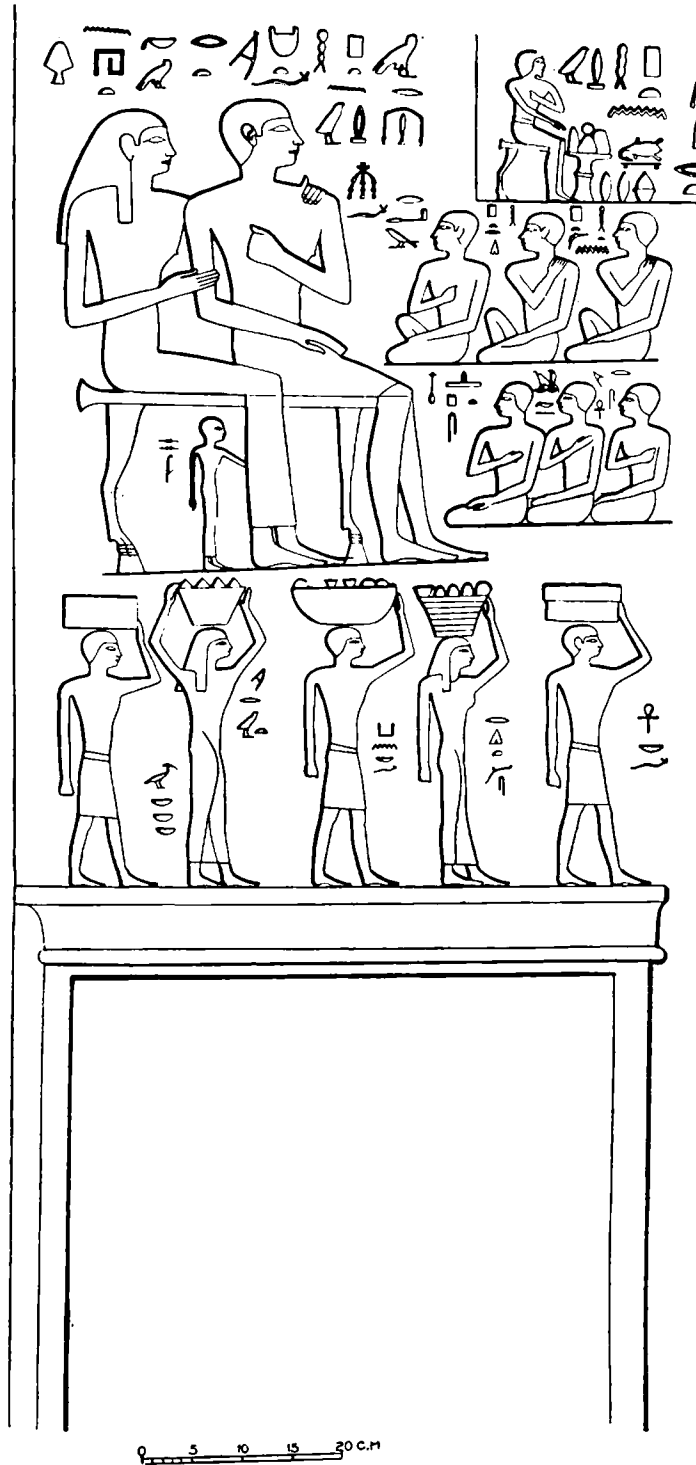


FIG. 95-C

(1) A common gesture at this period, cf. SMITH, W. S., *op. cit.*, Pl. 25, Fig. 24, 6; 21, a.

extended by her side, whilst her hand is held by the left one of the figure standing to her right. This latter figure is similar to the man already described, except the gesture of his left hand, which is correctly rendered. The three figures are entirely covered with a thin layer of rosy plaster. Very likely the group represents *NĜ-wdĜ-Pth* (on the right) his wife and on the left, their eldest son.

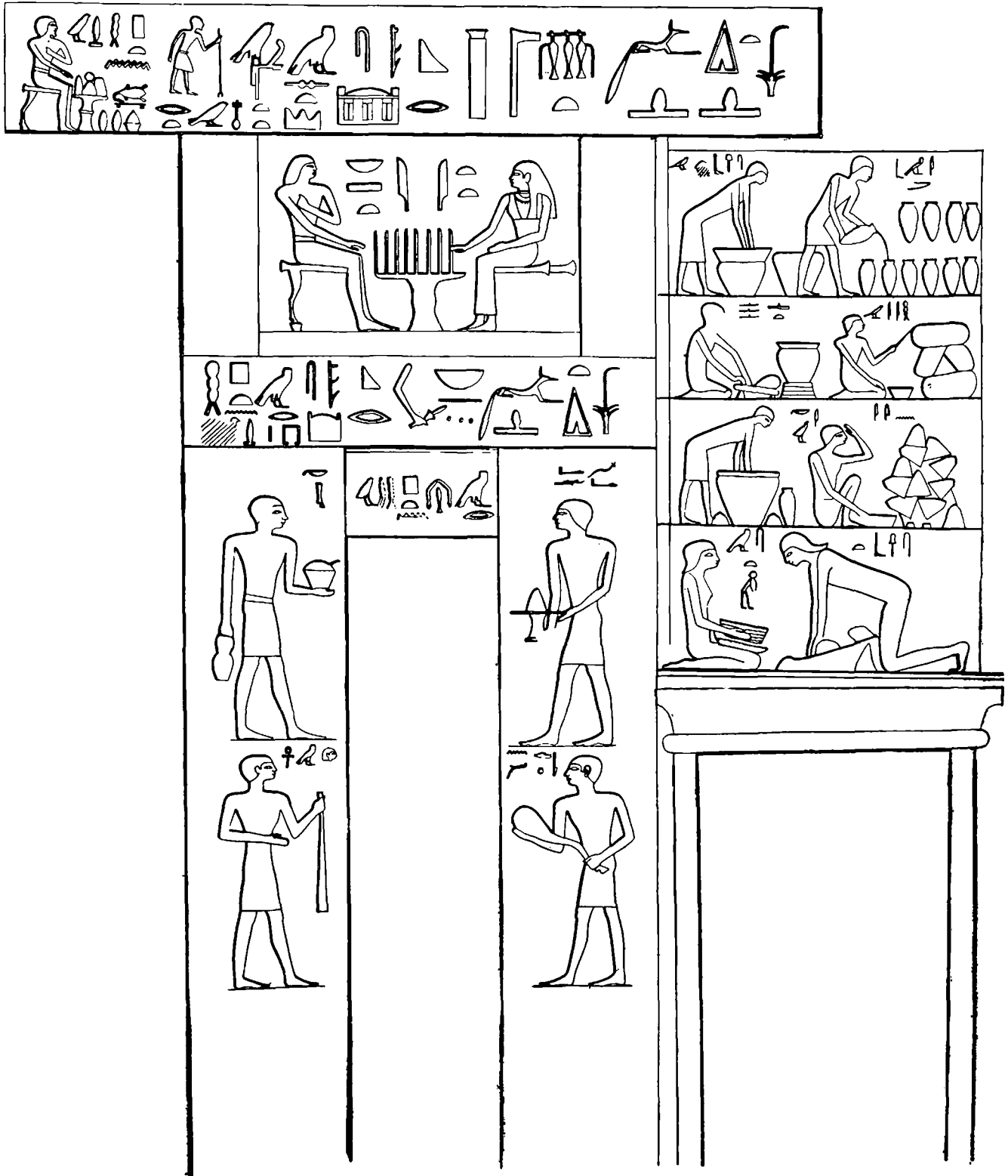


FIG. 95-D

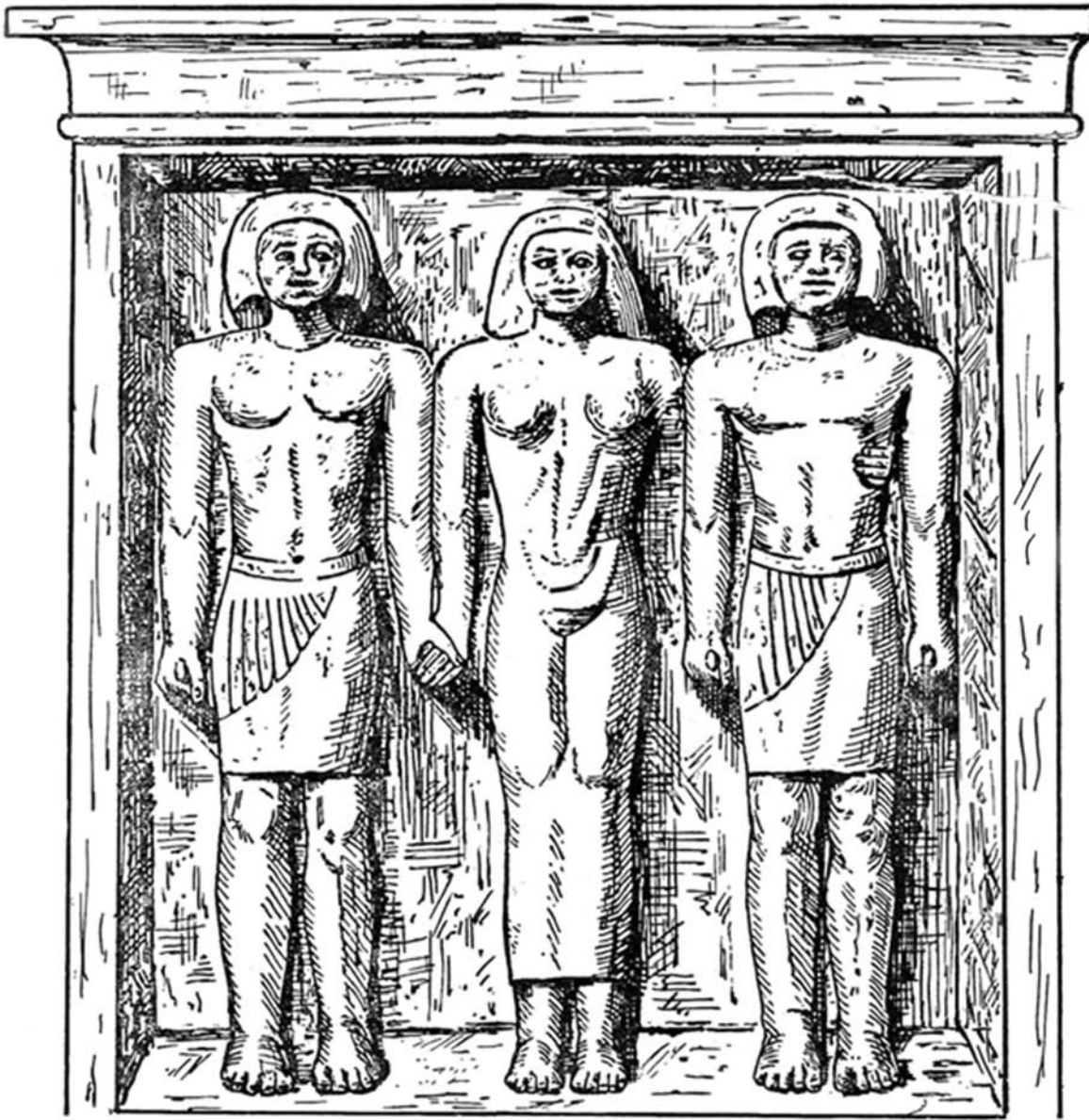
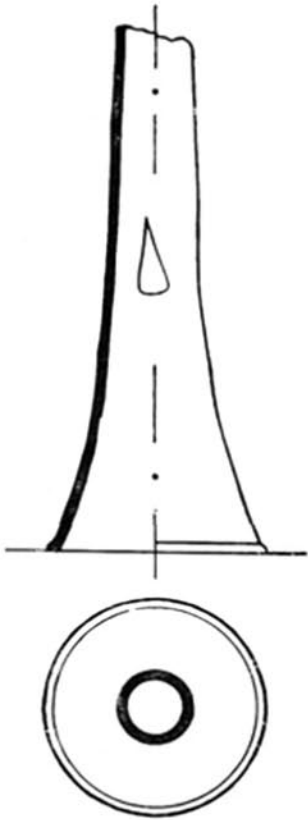
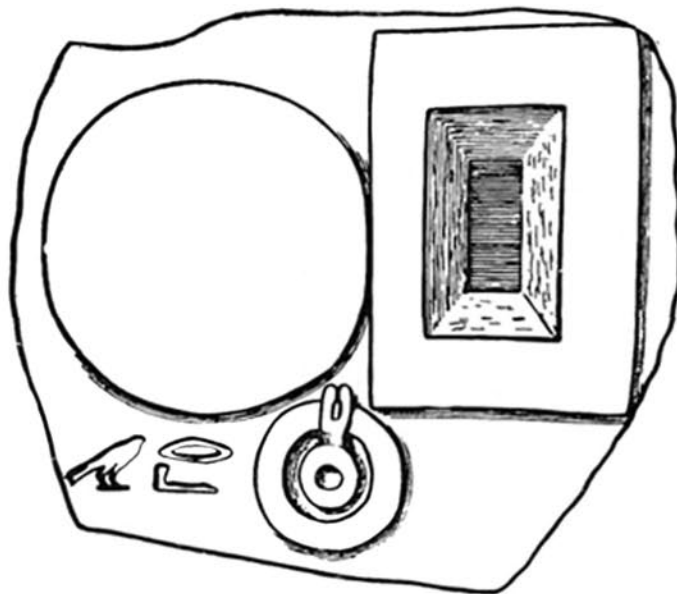


FIG. 95-E




10 0 10 20 c.m.


FIG. 95-F



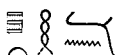





10 5 10 c.m.


FIG. 95-G



Below the settee stands a young boy, his left arm embracing the legs of his mother and his right one hanging down with the hand shown wrongly as an open left one. It is an error which occurs very often⁽¹⁾. Behind him his name reads:  *ssj*.

In front of the group and facing them we find six figures seated on the ground and drawn in two registers, the upper one showing three boys, the lower one three girls. It is remarkable that they are all squatting on the floor, each holding the left hand on the lap, the right open over the left breast, in the case of the three girls or round the left shoulder in the case of two of the boys. The foremost boy holds his right fist clenched over the middle of his breast. In front of every face, incised hieroglyphs give the names. These are introduced by the word:  "His children". The names are (Fig. 95-A, C, Pl. LXIII-A):—

- (1)  *Wr-R*.
 (2)  *Rdj-Pth*.
 (3)  *Ns-Pth* ⁽²⁾.
 (4)  *Nfr-htp-s* ⁽³⁾.
 (5)  *K3j-nj-Nbtj*.
 (6)  *Imj-r3-s'nh* ⁽⁴⁾.

The third false-door to the north (Fig. 95-D, Pl. LXIII-A) is of the same size and type as the middle one, with two jambs flanking the recess of the door, surmounted by the drum, the lintel and the meal-scene. The whole is topped with a long projecting lintel.

The drum is incised with:  "Overseer of the *Ka*-priests, *Nj-wd3-Pth*".



On the left jamb, two figures, one above the other, are incised, representing two offering-bearers. The top one holds a libation vase in his hanging right arm and a bowl and beaker in his left. He is dressed in a short kilt and his head is bare. In front of his face:  *K3j-whm* (-w) ⁽⁵⁾. The one in the lower register holds a long linen cloth in his left hand and a vessel in his right. In front of his face:  *tp-m'nh* ⁽⁶⁾.

⁽¹⁾ SMITH, W. S., *op. cit.*, p. 278, Figs. 114-117.

⁽²⁾ RANKE, H., *op. cit.*, p. 176.


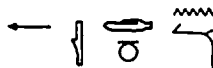
⁽³⁾ RANKE, H., *op. cit.*, p. 198.

⁽⁴⁾ Perhaps to be read "*mr-s'nh*", cf. RANKE H., *op. cit.*, p. 158, where the name

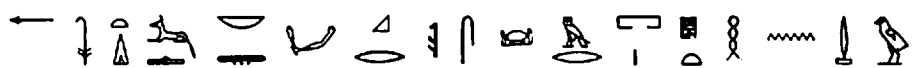
 also written .



⁽⁵⁾ RANKE, H., *op. cit.*, p. 339.

⁽⁶⁾ RANKE, H., *op. cit.*, p. 330.


On the right jamb, the upper figure carries with both hands a table with a loaf upon it. Above him his name is written :  d''⁽¹⁾. Below him a second man carries in both hands a haunch of beef. In front of his face his name :  nj-sw-Kd⁽²⁾.

The lower lintel is inscribed with the following line :—

 "May the King be favourable and grant, may Anubis lord of the sacred land, be favourable and grant, a burial, (to) the overseer of the house, *Nj-wd3-Pth*".

Above this lintel a squarish tablet is carved with the scene of the meal. On the left sits a man on a settee of which only the back legs are indicated ; his right arm stretched out towards the table, his left bent over his breast. His face is bearded and he wears a long wig. In front of his face his name :  nb-ist⁽³⁾. Opposite him sits a woman on a squarish seat, wearing a long wig and dressed in a long robe. She stretches her left arm out upon her lap and her right is extended over the offering-table. The realistic touch of the artist is here again characterized by his showing on the woman's side of the table only three loaves as against the five which appear, balancing them off, on the other side of the table. It is a feature similar to that appearing on the second false-door. In front of the woman's face is her name :  iti⁽⁴⁾.

The long lintel at the top of the door projects about 1.5 cm. from the surface of the rock and is incised with the following inscriptions (Fig. 95-D, Pl. LXIII-A) :—

 "May the King be favourable and grant, may Anubis the foremost of the divine booth be favourable and grant, a burial in the western cemetery, (after) a very good old age to *Nj-wd3-Pth*".

The lintel ends on the left side with a small figure of the owner sitting on the settee, the back legs of which appear ; in front of the owner is a table upon which loaves are piled.

Beside it are shown a trussed goose and three vessels (for drink).

The last panel at the northern end of this western wall is certainly the most interesting one, since it shows most clearly the realistic touch of the artist (Fig. 95-D, Pl. LXIII-A).



At the bottom a group of two statues is hammered out of a recessed niche framed with cornice and jamb ; setting sketched in outline with red ochre. The two figures, of a man and a woman, are left unfinished.



(1) RANKE, H., *op. cit.*, p. 405.



(2) RANKE, H., *op. cit.*, p. 179.

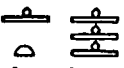
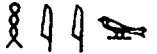
(3) RANKE, H., *op. cit.*, p. 183.


(4) It is to be noted that the signs  were first written and then cancelled to be replaced by the name : .


The last  is cut over by the bold  of the second name.

Above this niche there are four registers (Fig. 95-D, Pl. LXV) showing different scenes incised in "relief dans le creux". In the lower scene a woman is kneeling over a hand-mill and working the stone with both hands. Above her:  *s3bt* (1). Facing her, another woman is kneeling holding a sieve (?). In front of her:  *smwt* (2). Neither woman has a wig, and their natural unkempt hair is shown over their necks. Both women are seen in exact side-view projection without the formal rabatement of the bust dictated by the Egyptian frontality-law. Such exact profiles are known from many examples of figures at rest or in motion (3).

The register above this one is occupied by two men. The one on the left is kneading dough in a huge earthenware vessel, the base of which is surrounded by a retaining mud wall. A water jar provides the necessary water. In front of him:  *ikw* (4). The man on the right is shown sitting with both legs upwards: he is heating the earthenware pots to receive the dough. In these heated pots bread was baked. The man protects his face from the scorching heat with his uplifted left hand, in a neat realistic gesture. In front of him his name:  *pnj* (5). Here again, in this register, the man bending over the kneading-jar is seen in true side-view.

The register above this one shows two figures at work. On the left a seated woman (?) presses with both hands a piece of dough (?) set on a tray. In front of her a large vessel is set upon a low circular stand. In front of her:  *htprw* (6). On the right is a man seated on a low seat holding in both hands a stick, with which he seems to move the fire on which he cooks the large pastry (?). In front of him:  *hjj-wr* (7). In this register, the figure of the woman sitting on the left side is seen in true side-view.

In the top register, on the left side, a woman stands, bent over a large broad-rimmed vessel set upon a low stand and with both hands she stirs the mixture in it. Above her head:  *s3bt-wr* (8). In front of her, another large vessel is shown being placed behind the figure on the right.

This second figure is that of a man pouring the contents of a jar into another one set in the front row. In front of his face:  *imb* (9).

The woman bending over the vessel is again in true side-view, while the one holding the jar shows, in a realistic way, the movement of the uplifted shoulder. The whole panel is a most successful example of an informal, quick but lively sketch.

(1) RANKE, H., *op. cit.*, p. 299.

(2) RANKE, H., *op. cit.*, p. 307.

(3) SMITH, W. S., *op. cit.*, pp. 314-5, Fig. 179, 182 a.

(4) RANKE, H., *op. cit.*, p. 47.

(5) RANKE, H., *op. cit.*, p. 132.

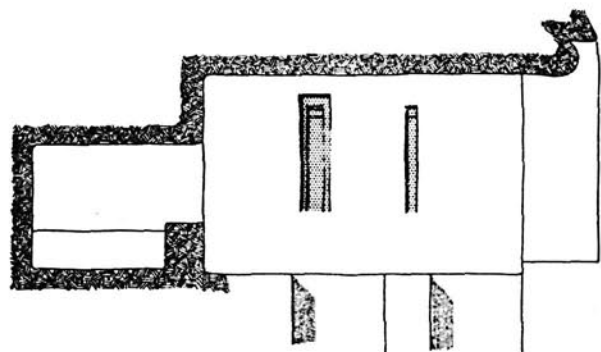
(6) RANKE, H., *op. cit.*, p. 233.

(7) RANKE, H., *op. cit.*, p. 260.

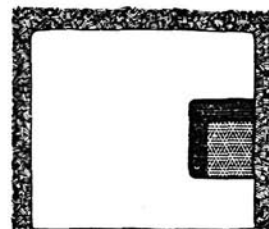
(8) RANKE, H., *op. cit.*, p. 299.

(9) RANKE, H., *op. cit.*, p. 26.

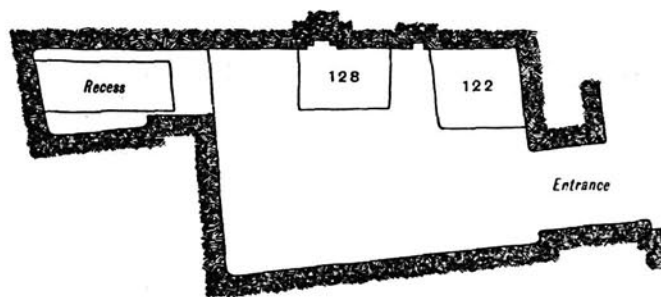
ROCK TOMB OF NEFER-HR-N-PTAH



West Elevation

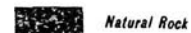


South Elevation

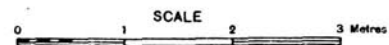


Plan

REFERENCE




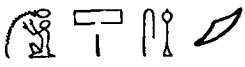

Natural Rock



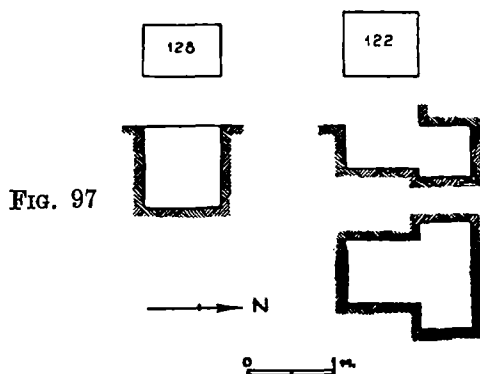
Fawzy Ibrahim

ROCK-TOMB OF NFR-HR-N-PTH

TITLES

1.  "Royal acquaintance"
2.  "Inspector of artisans of the *w'bt*-workshop".
3.  "Overseer of the carpenters".

It is an unfinished rock-tomb adjoining that of *Nj-wd3-Pth* and lying to the east of it ⁽¹⁾ (see General Plan). It consists of a small room (2·85 × 1·80 metres) cut in the face of the cliff, with a door 77 cm. wide (Fig. 96). The walls are simply hammered out of the rock, and the eastern and southern walls have been largely patched up with pinkish rose-coloured plaster, still retaining the mark of the workmen's fingers. The ceiling (about 1·70 metres in height) is not level and has a large cleft in the middle. A small opening (63 × 80 cm.) in the southern wall at the western corner leads to an irregular small cachet (1·60 × 0·90 × 1·15 metres) prepared for burial. Square graves are hollowed out of the floor. They are marked on the general plan as Shafts 122 and 128. They do not show any trace of burials (Fig. 97).



The chief interest of this tomb is afforded by the unfinished low-reliefs on the two jambs of the entrance-door and the drawings on the adjoining eastern wall. They show the different stages of preparation from a mere sketch in red ochre to the dressed surface in which the figures are hammered after a red ochre outline, supplemented with details in black line.

The sketch stage is illustrated by a scene drawn on the uneven, hammered, eastern wall of the room, close to the door. A rectangular frame of one line of red ochre pigment surrounds the scene (0·70 × 1·02 metres) (Fig. 98, Pl. LXVII-A).

Two figures are shown standing side by side in full front-view, a man to the right, both hands clenched by his side; and a woman beside him, her right hand hanging open while the left is passed round the man's shoulder. A small figure stands under her right

⁽¹⁾ It is of type R.C. IVa, cf. REISNER, G. A., "A History of the Giza Necropolis", Vol. I, p. 241, Fig. 147.

hand at the bottom of the scene. The features of the faces are identical: two parallel vertical lines for the nose reaching up to the level of the lower ridge of the wig, and even, in the case of the woman, to that of the upper ridge; two short parallel horizontal lines represent each eye and eyebrows, and two short horizontal lines the lips. The face is round, rather larger in width than in height, with a separate sharp curve for the chin. The wig is indicated by an outer curved line above the upper half of the face.

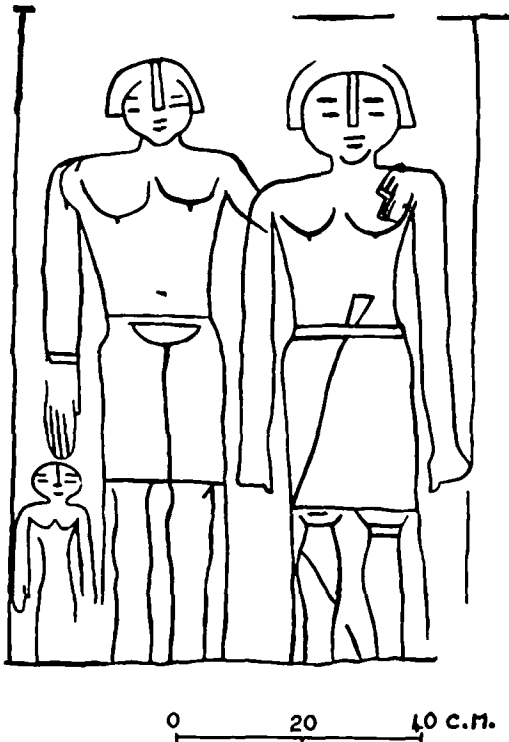


FIG. 98

The man's face is rather larger than the woman's. Apart from this point both can also be identified by the different dresses, and the positions of the hands. The breasts are shown pendant, as two curves with a nipple at their lowest point, very likely a rabatement of their view if projected from above, *viz.* plan-projection. The curves are more rounded in the woman, an indication of a deeper projection. Such a projection is used in the rarely found drawings of a woman where the breasts are shown in front-view⁽¹⁾. The leg is rendered by two vertical lines, slightly curved outside with an indication of the knee by two parallel horizontal curves. On either side of each figure, the outline of the apron is carried down vertically. Nothing indicates the feet. This is the preparatory free-hand sketch⁽²⁾ for a group of statues in high relief. The simple and efficient stylization of the lines reveals a high standard of draughtmanship.


On the left jamb adjoining this an outline of two figures of the same height as the above-mentioned statues are hammered out in a direct line in red ochre (Pl. LXVII-B). They represent a man in a walking attitude holding a long staff in his right hand and

(¹) SMITH, W. S., "A History of Egyptian Sculpture and Painting in the Old Kingdom", 1946, Fig. 198, p. 323.

(²) SMITH, W. S., *op. cit.*, p. 246.

a sceptre (?) in his left. He is dressed in a short projecting kilt and is followed by a woman, smaller in size and dressed in a long robe. She holds her right hand over her left shoulder, her left arm is hanging down by her side with open hand. The rock has been dressed to an approximately vertical and level surface. The relief stands about 1.5 cm. off the rock. The outline in red ochre remains in some parts. For secondary relief, showing different levels between the arms bent over the breast, or between the dress and the legs, it is sculptured at the original level area and therefore reaches deeper.

On the right jamb two smaller figures stand facing towards the interior (Pl. LXVI-B). The man is bearded and leaning upon a long staff, whose upper end is engaged under his left arm. With the right hand he holds the left hand of a woman standing behind him. She wears a long robe and a short wig. The original sketch was in red ochre and has been corrected in black round the wig, the eye, the nose and the chin (1). The first draught seems to have represented the left arm of the woman hanging by her side, and this appears to have been altered so that the left hand might be held by the right hand of the man. The surface is dressed to a vertical level plane and the relief is 1 cm. deep. The outline has been chiselled out after a bevelled cross-section, the strokes being at right angles to the outline (2).

On the western wall of the room four vertical rectangular recesses show the first stages of the sculpture of two false-doors, with an indication of the drum. Above the door and half-way between its deep jambs (Fig. 99, Pl. LXVI-A) a roughly hewn and inscribed drum spans the entrance, which seems to have been blocked up with a wall of large crude bricks. The inscriptions are surmounted by a rectangle roughly incised and coloured in alternate light green and red patches: ↓  "The royal acquaintance, (3) inspector of the artisans of the *W'bt*-workshop (4), overseer of the carpenters (5) *nfr-hr-n-ptḥ* (6). His beloved wife concubine (7), *tnt-it-s(?)*" (8).

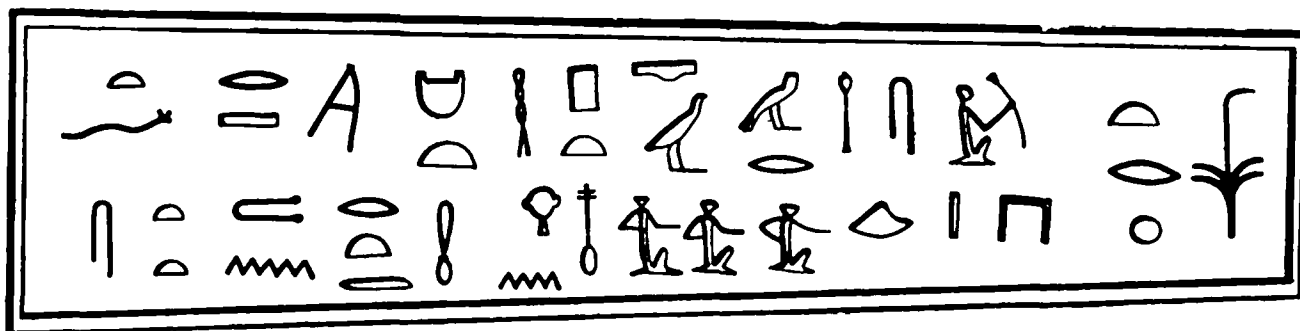


FIG. 99

0 5 10 c.m.

(1) For alterations in drawings and low reliefs, cf. SMITH, W. S., "A History of Egyptian Sculpture and Painting in the Old Kingdom", 1946, p. 252.

(2) cf. SMITH, W. S., *op. cit.*, pp. 247-248.

(3) W. B., II, 446.

(4) S. HASSAN, "Excavations at Giza", 1930-31, p. 9.

(5) W.B., II, 190.

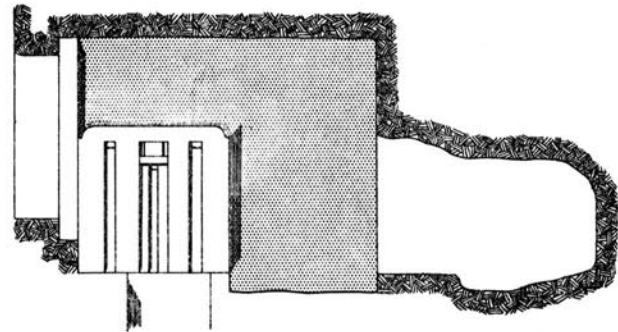
(6) RANKE, H., *op. cit.*, p. 198.

(7) JUNKEB, H., "Giza", V, 141, 146.

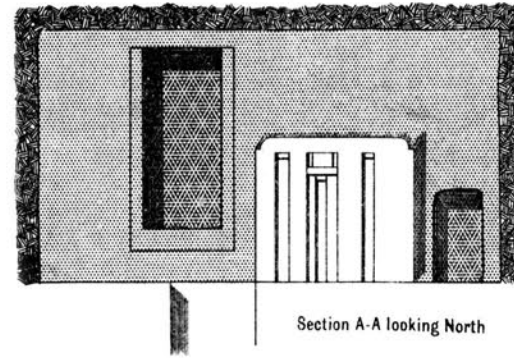
(8) "The one who belongs to her father", cf. RANKE, H., *op. cit.*, p. 358. The name may also be read (*tn-it-s*), cf. RANKE, H., *op. cit.*, p. 392.

[This page is intentionally blank.]

ROCK TOMB H



Section B-B looking East

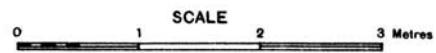


Section A-A looking North

REFERENCE

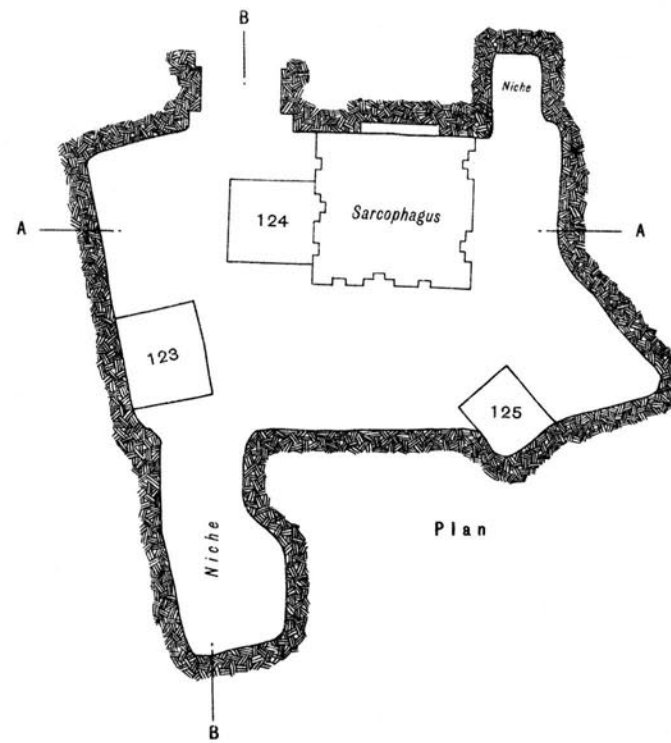


Natural Rock



SCALE

3 Metres



Plan



Fawzy Ibrahim

FIG. 100

SARCOPHAGUS ROCK-TOMB "H"

This rock-tomb lies to the east of the tomb with the unfinished sculptures, and seems to be the last to the east in the row of rock-hewn tombs (*see* General Plan). Its level is lower than that of the rock bed. It opens through a door narrow jambs (1·60 × 0·65 metres). On both sides of the entrance two short walls (0·90–1·10 wide and 0·22 metres deep) abut, leaving a passage as wide as the door itself but slightly higher. Above the door is a drum without inscriptions. The tomb consists of a single room, irregular in plan and unfinished ⁽¹⁾ (Fig. 100, Pl. LXVIII).

The height of the ceiling (1·80 × 2·05 × 2·18 metres) roughly levelled, varies according to the level of the rock floor which presents several stepped areas. The walls are only roughly hammered out vertically and clearly show the marks of chisels. On the ceiling there are round traces of picks.

The main feature of the room is a rock-hewn sarcophagus adjoining the northern wall to the left of the entrance door (Fig. 101-A, B).

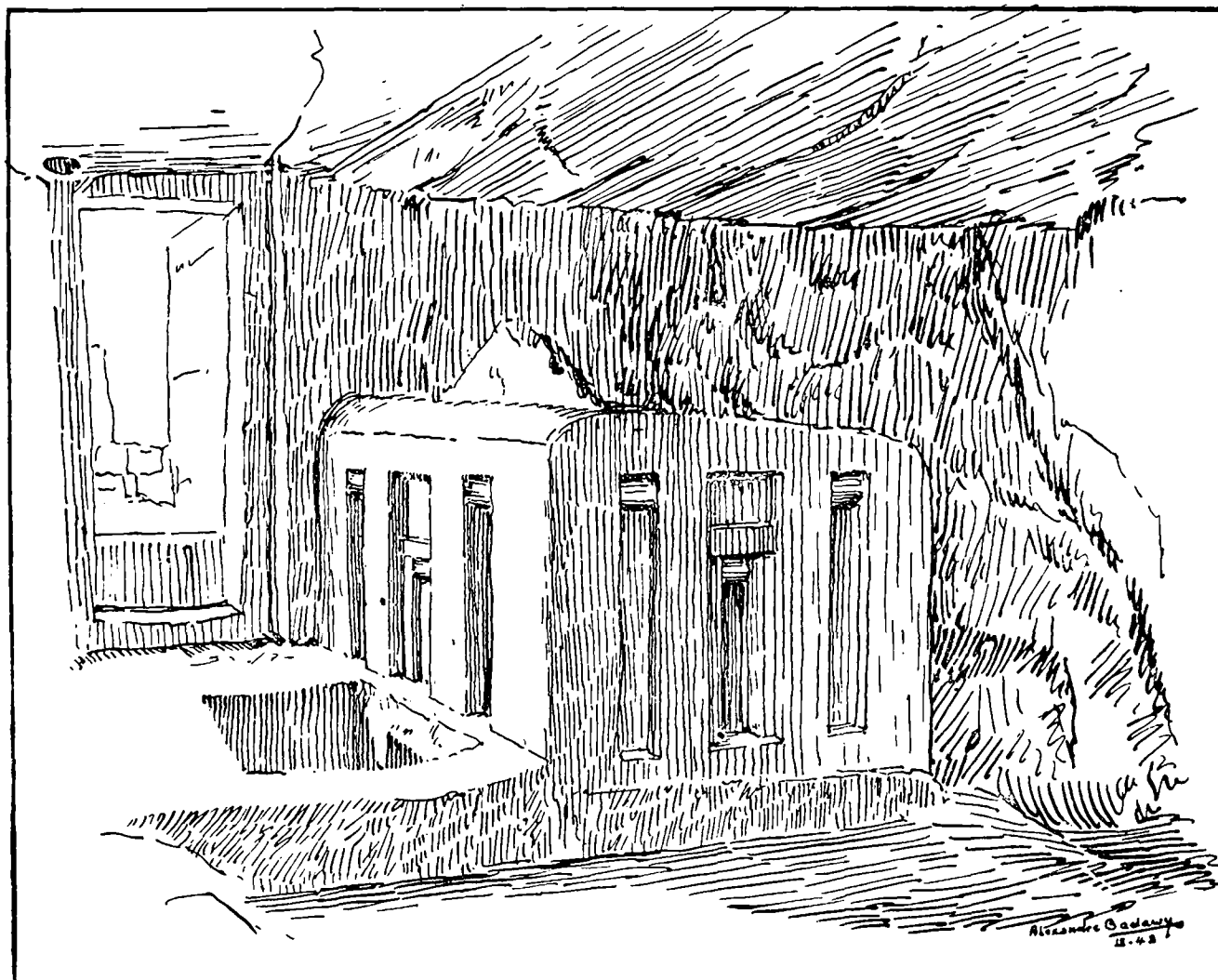


FIG. 101-A

(1) It could be classified under R.C. IV b; cf REISNER, "A History of Giza Necropolis", Vol. I, p. 242, Fig. 148.

It is square in plan (1.25 metres N.S. \times 1.30 metres E.W.). The three faces are vertical (75 cm. in height). The western and southern faces show a motif consisting of a false-door recess flanked on either side by a simple recess with drum. The central false-door has recessed jambs and a drum topped with a lintel above which appears the squarish panel of the offering-list

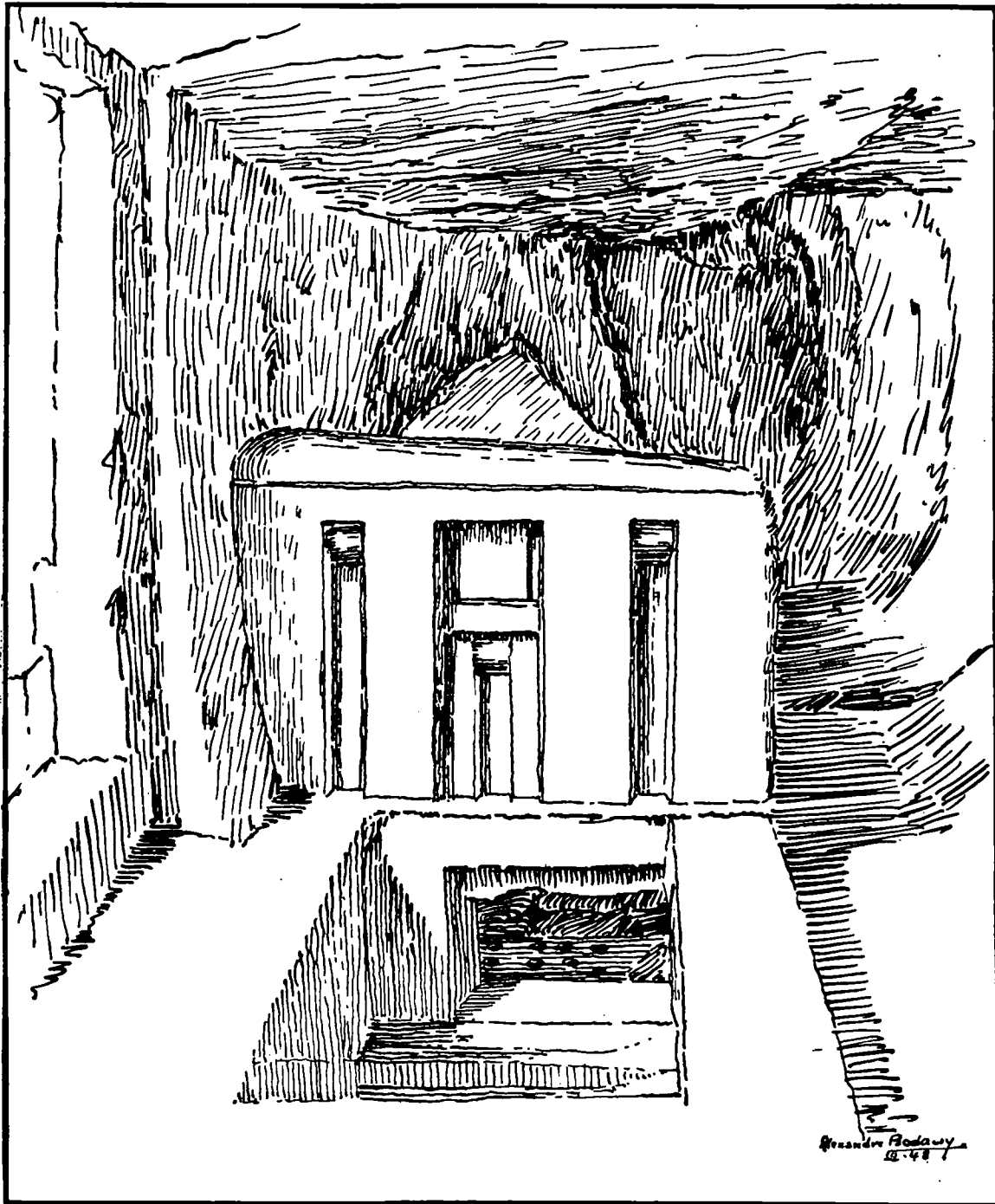


FIG. 101-B

The eastern face has two false-doors similar to the central one of the two other faces. These sculptures are simply dressed, without inscriptions. Plaster seems to have been used to patch up certain rock failures. The top part shows a rectangular opening (1.10 N.S. - 0.70 metres E.W.) with a ledge (11 cm.) on its eastern and western sides. This was covered with a flat stone roughly

hammered, which was set as part of a flat curved top, whose eastern and western corners round down on the sides of the sarcophagus. The interior walls slope inwards so that the bottom is wider than the opening. It contained the skeleton of a man. No funeral furniture was found.

Outside and along the western side a square Shaft No. 124 (Fig. 102) is cut in the rock floor ($70 \times 70 \times 80$ cm. deep); on its eastern wall an opening, closed with a flat stone set in it, leads to a square hole under the sarcophagus itself. It (also) contained bones of a child's skeleton.

124

The floor here is a stone flag pierced with nine round holes in two rows and covers another burial which contained bones of a small skeleton.

Another shaft is cut in the south-western corner of the room No. 123 leading to an excavation under the western wall. A second shaft opens also in the south-eastern corner No. 125. Both are unfinished and unused (Fig. 103).

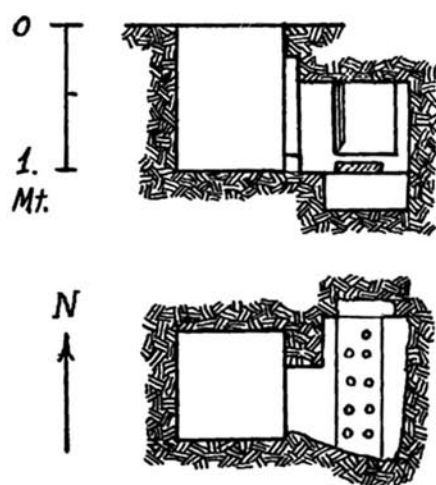


FIG. 102

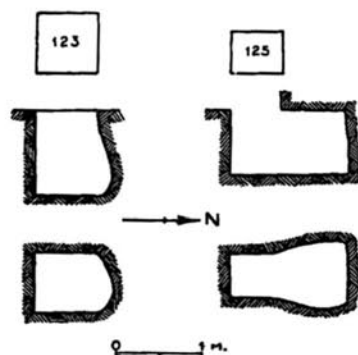


FIG. 103

In the northern wall a square opening, adjacent to the eastern side of the sarcophagus, leads to a squarish cachet, level with the floor of the room.

[This page is intentionally blank.]

BRICK VAULTS AND DOMES IN THE GIZA NECROPOLIS

by

DR. ALEXANDER BADAWY

Excavations of the University of Alexandria in the Giza Necropolis during the 1949-50 season have brought to light interesting architectural elements, the most important of which are the vaults and domes. These elements, although mostly known before, present special features which make them invaluable documents for the study of the evolution of early architecture in Egypt.

FLAT VAULTS

Between the open court and the vestibule (?) of the Mastaba of *Nfri*, an archway in excellent state of preservation is covered with a flat vault resembling the three-centred arch of Gothic architecture (Fig. 104).

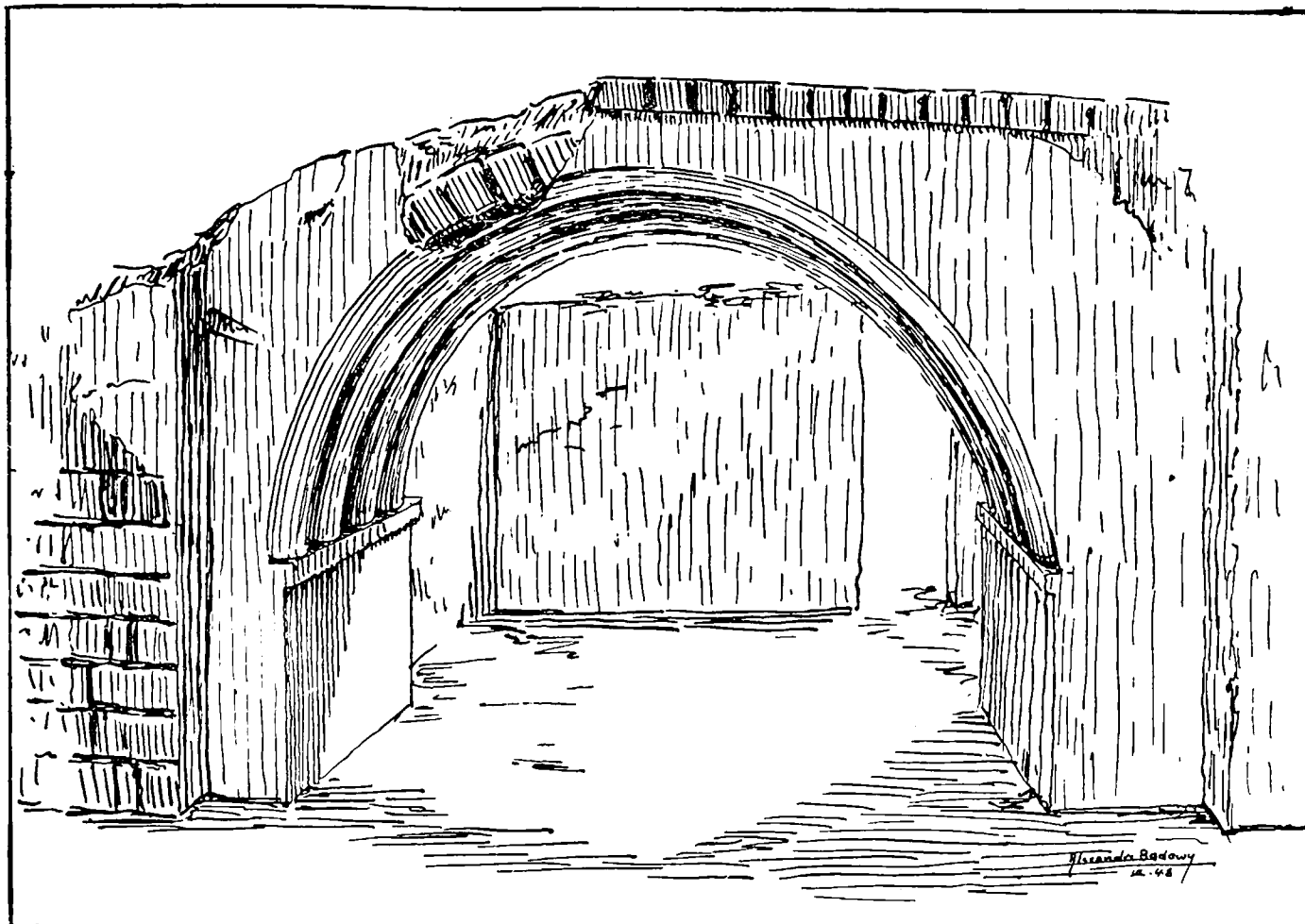
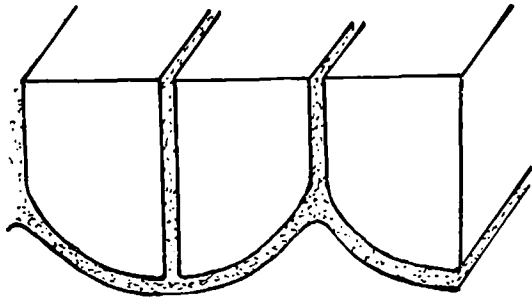


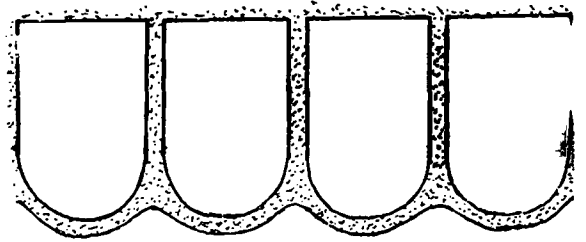
FIG. 104.—Flat ribbed archway as seen from the court of *Nfri*'s chapel

From a flat string moulding at 73 cm. above ground springs the vault with span 2.50 metres, height 96 cm. and depth 65 cm. A flat arch of the same type forms the front of an alcove or recess in the chapel of the Mastaba of *Sib.f* (1) in the Minor Cemetery at Giza (Fig. 105).

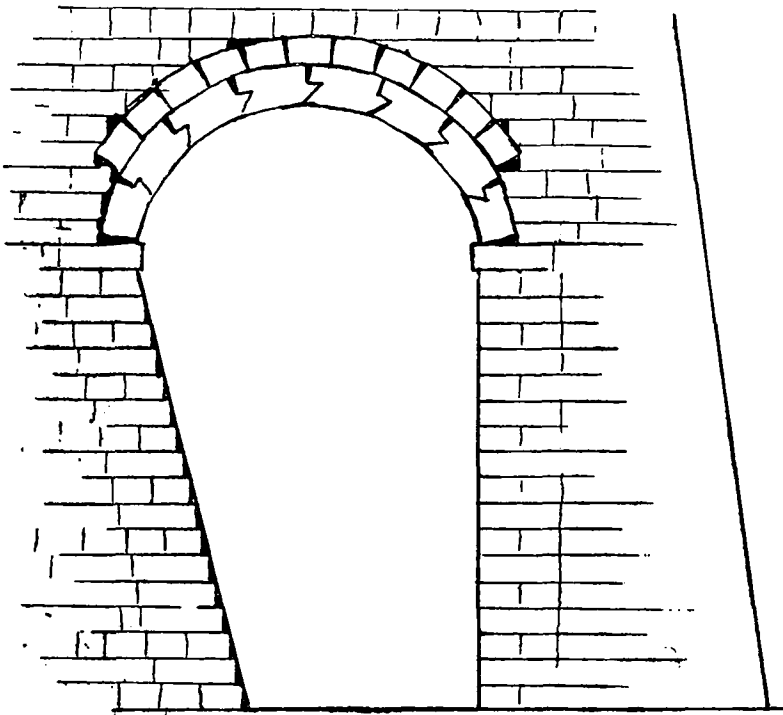
(1) G. 3033. cf. FISHER, Cl. S., "The Minor Cemetery at Giza" Philadelphia, 1924, p. 115, Pl. 19.



G 2098



G 3024



G 3033

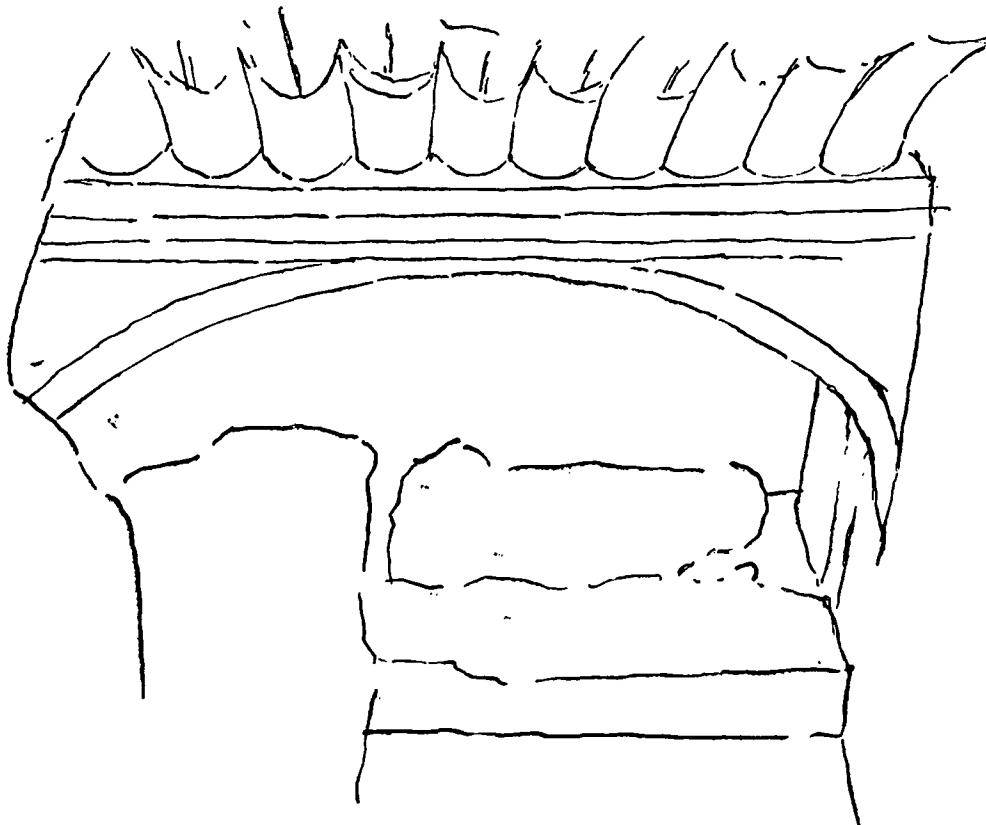
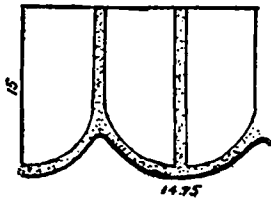
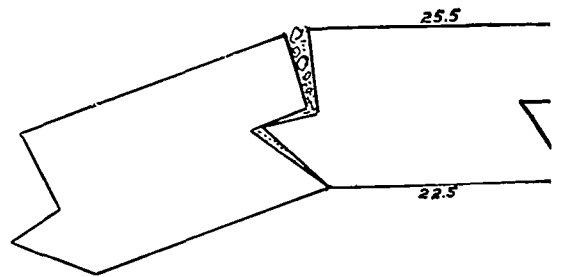


FIG. 105.—Ribbed vaults in Minor Cemetery at Giza

(Cf. FISHER, Cl. S., "The Minor Cemetery at Giza", 1924, Figs. 52, 96, 107, 198. Pl. 18.)

This one of *Nfri*¹ however, differs slightly, being opened through and presenting the rare feature of ribs. These are adjacent elements, semi-circular in section, running transversely to the archway axis, from one jamb to the other. The vault shows four ribs and is two bricks deep between the external and internal faces. The bricks are radiating, placed as headers, with their longer side parallel to the axis of the opening. They are of peculiar shape. A special mould had to be used, with one of the long sides (32 cm.) shaped into two adjacent semi-circles (Fig. 106).

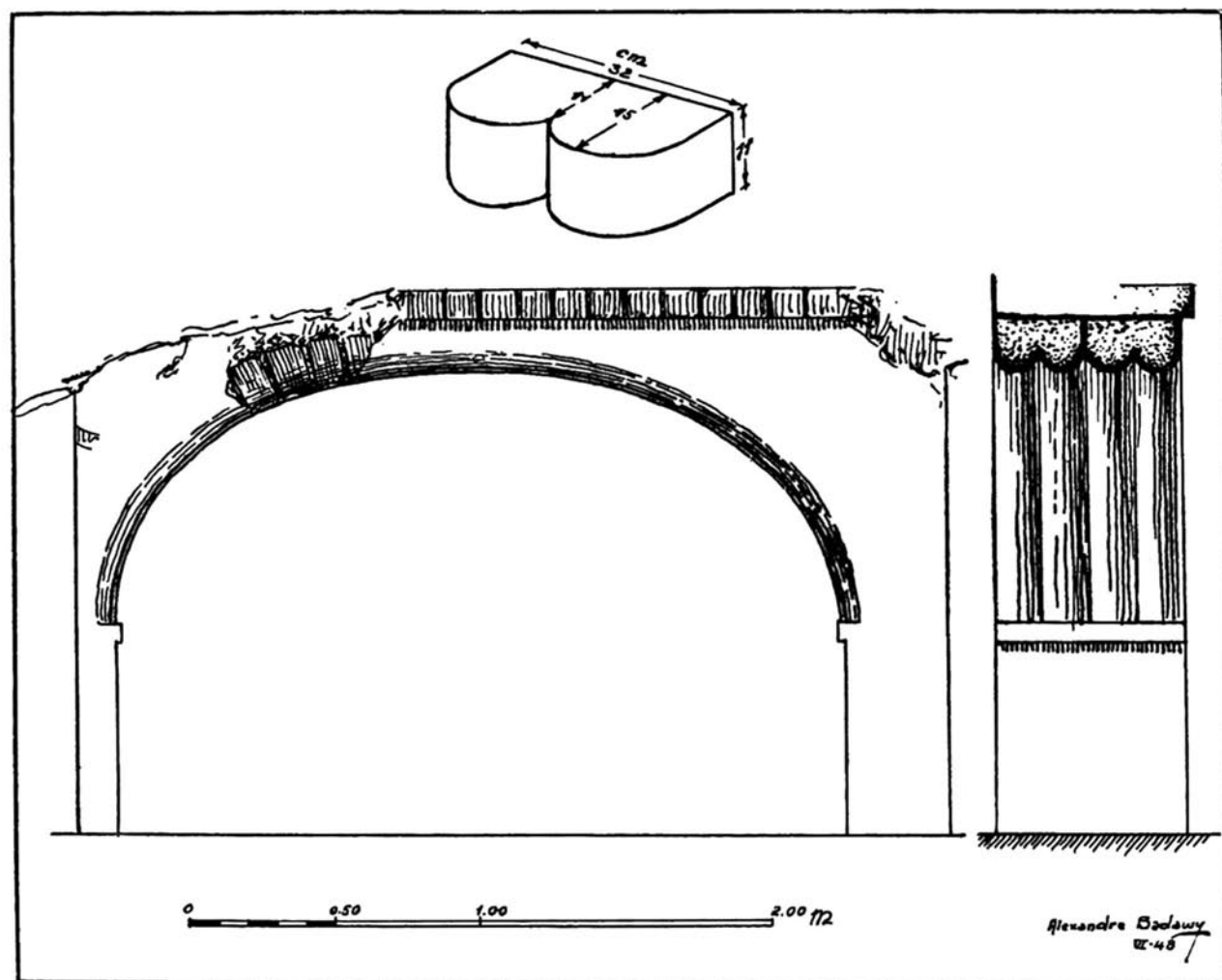


FIG. 106.—Elevation from the court and section of flat-ribbed archway in *Nfri*'s chapel


The arch is only one brick thick (15 cm.). The ribs are plastered over with a thick layer of mud and a coat of mortar, painted in Pompeian red. The plinth is topped with the projecting white flat string and the external and internal faces are covered with whitewash.

Similar ribbed vaults had been found near-by in the Minor Cemetery (¹), showing the same external features as to shape, size and colour, but quite different in construction. Fisher, who discovered them, called them "reeded vaults", a name which indicates the origin of their design. Nothing could have led the architect to use such curious features but the wish to

(¹) G. 2098, 3024, cf. FISHER, *Cl. S.*, *op. cit.*, pp. 65, 106, 115.

transpose the characteristic aspect of the interior of reed vaults and arches into brick architecture. For some reason, which may be related to artistic conservatism or more probably to religious tradition, such elements of design, originating purely out of the forms of vegetable materials, were considered worth retaining, and adapted to the new material used: crude brick.

The extremely rare occurrence of flat vaults in excavations does not imply their restricted use. In reed architecture we find them widely used ever since the remotest times (Fig. 107).

Archaic drawings have preserved for us the aspect of such diverse constructions as boat-cabins, huts, sanctuaries, carrying chairs, covered with flat vaults, and arches of bent and pliable materials such as reeds, palms, or papyrus stalks. We know of such vaults in the hieroglyphs showing façades of pavilions,  coloured red. One is justified in speculating whether the upper portion of the hieroglyph represents the structure of curved stems in the façade or is an attempt to indicate the ribs along the vault, with vanishing decrease of size due to perspectival deformation. Such ribs are represented on the outer face of an archaic boat model. The façade of a Hathor temple, similar to those of the North and South buildings of the Deser pyramid complex, is shown in detail at Deir el-Bahari (1).

Archaic flat arches in brick are known. Among the earliest examples (2) are the brick arches of the IIIrd Dynasty at Beit Khallaf, in the Deser complex at Saqqara, in the Tomb of Idu (VIth Dynasty) at Dendara, in a passage of Ra'hotep's tomb, and in Kanofer's chapel (3) at Giza. Superstructures of tombs imitate such vaults on their exterior, and show coloured ribs transversal to the tunnel. Later pictured (Fig. 108) data add to this list, by showing us the use of wooden doors, mobile tanks, sarcophagi and, transposed in brick or stone, doorways, silos, magazines and superstructures of tombs represented with flat arches or vaults as coverings. Chapels and kiosks of the New Kingdom and later periods seem to have been covered with flat vaults of wood (4).

Flat arches and vaults were actually imitated in stone in the funeral chamber of the Sesostri II Pyramid at Illahun, in a Middle Kingdom mastaba at Dahshur, in a subterranean passage cut in the rock and propped up with sandstone arches in two halves at Deir el-Bahari (5) and in the chapels of Seti I Temple at Abydos. Rock-cut tombs and temples exhibit the same features at Beni-Hassan (Amenemhat, Khnumhotep), Aswan (Sarenput), in the sanctuary of the Ra'mses II Temple at Wadi es-Sebu'a (XIXth Dynasty) and in the vaults of the Serapeum. It is quite significant that both vaults in the Khnumhotep II and Amenemhat rock-tombs at Beni-Hassan are decorated with an imitation of matwork hung from the head purlin.

(1) NAVILLE, E., "Deir el-Bahari", IV, Pl. CIII.

(2) CAPART, J., "L'Architecture", Pl. 8, 14, 57.

(3) REISNER, G. A., "A History of the Giza Necropolis", 1942: G. 1203, Pl. 12 b, Fig. 94 b; G. 1457, Fig. 12, 228., p. 50.

(4) BORCHARDT, L., "Tempel mit Umgang".

(5) NAVILLE, F., "The XIth Dynasty Temple at Deir el-Bahari", II, 1910, p. 3, Pl. XXII; cf. CAPART J., "Etudes et Histoire", p. 273.

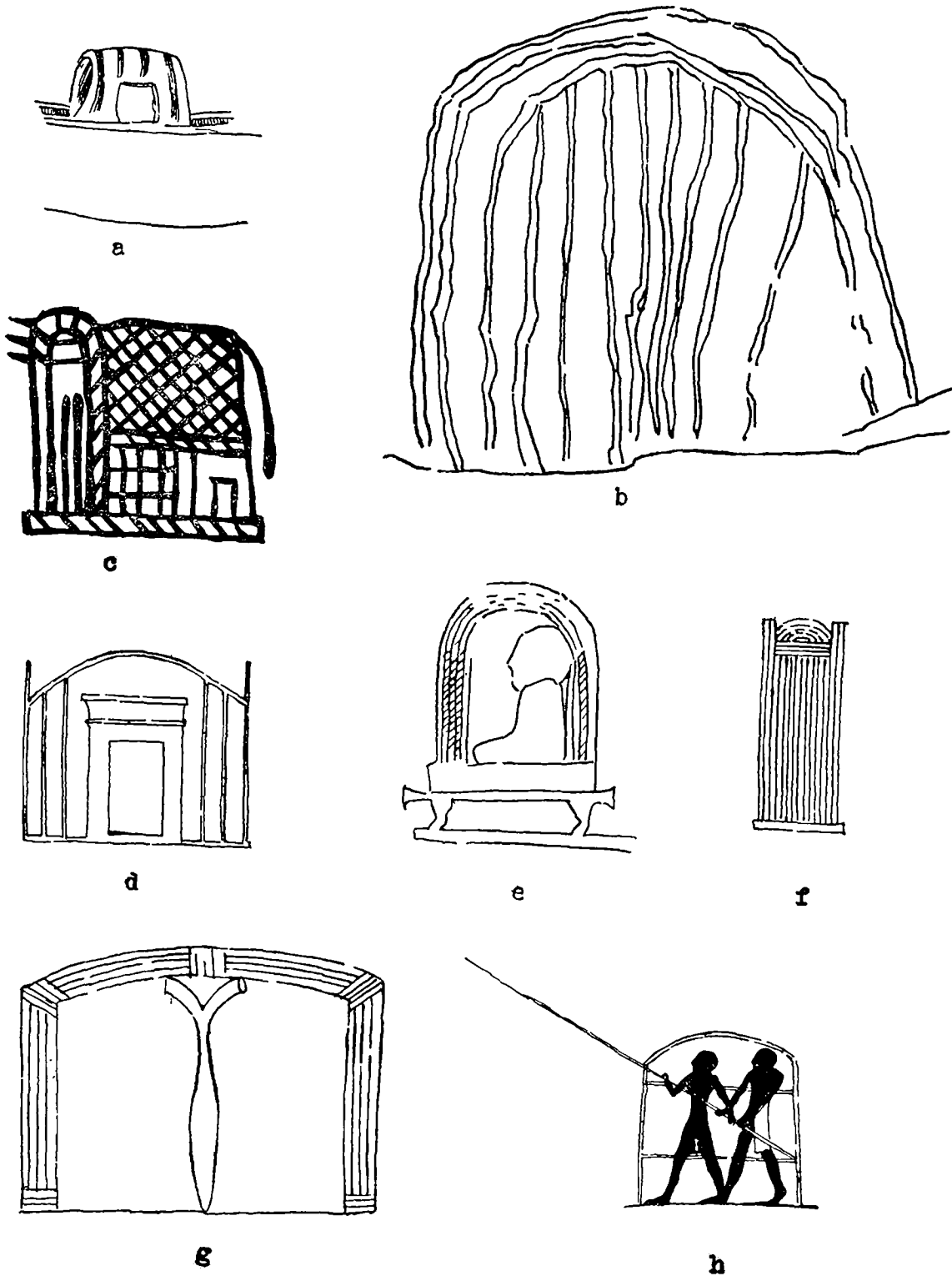


FIG. 107.—Representations of flat arches of reeds:

- (a) Archaic model of boat (BOREUX, Ch., *Études de nautique égyptienne*, M.I.F.A.O.L., Fig. 28).
 (b) Rock engraving of hut (WINKLER, A., *Volk und Völkerbewegungen*, 1937, Abb. 48).
 (c) Animal-shaped sanctuary (EMERY-SAAD, *Hor-Aha*, p. 99, No. 47).
 (d) Rock engraving of façade of building (BORCHARDT, L., *Tempel mit Umgang*).
 (e) Archaic carrying chair from Na'rmer's mace head (QUIBELL, J. E., *Hierakonpolis*, Pl. XXVI-B).
 (f) Hieroglyph of light materials sanctuary (BORCHARDT, L., *Sahure*, 19).
 (g) Hieroglyph of *sh*-building (GRIFFITH, F. Ll.: *Hieroglyphs*, Fig. 9).
 (h) Mobile tank of light materials (NEWBERRY, P., *Beni-Hassan*, I, Pl. XIV).

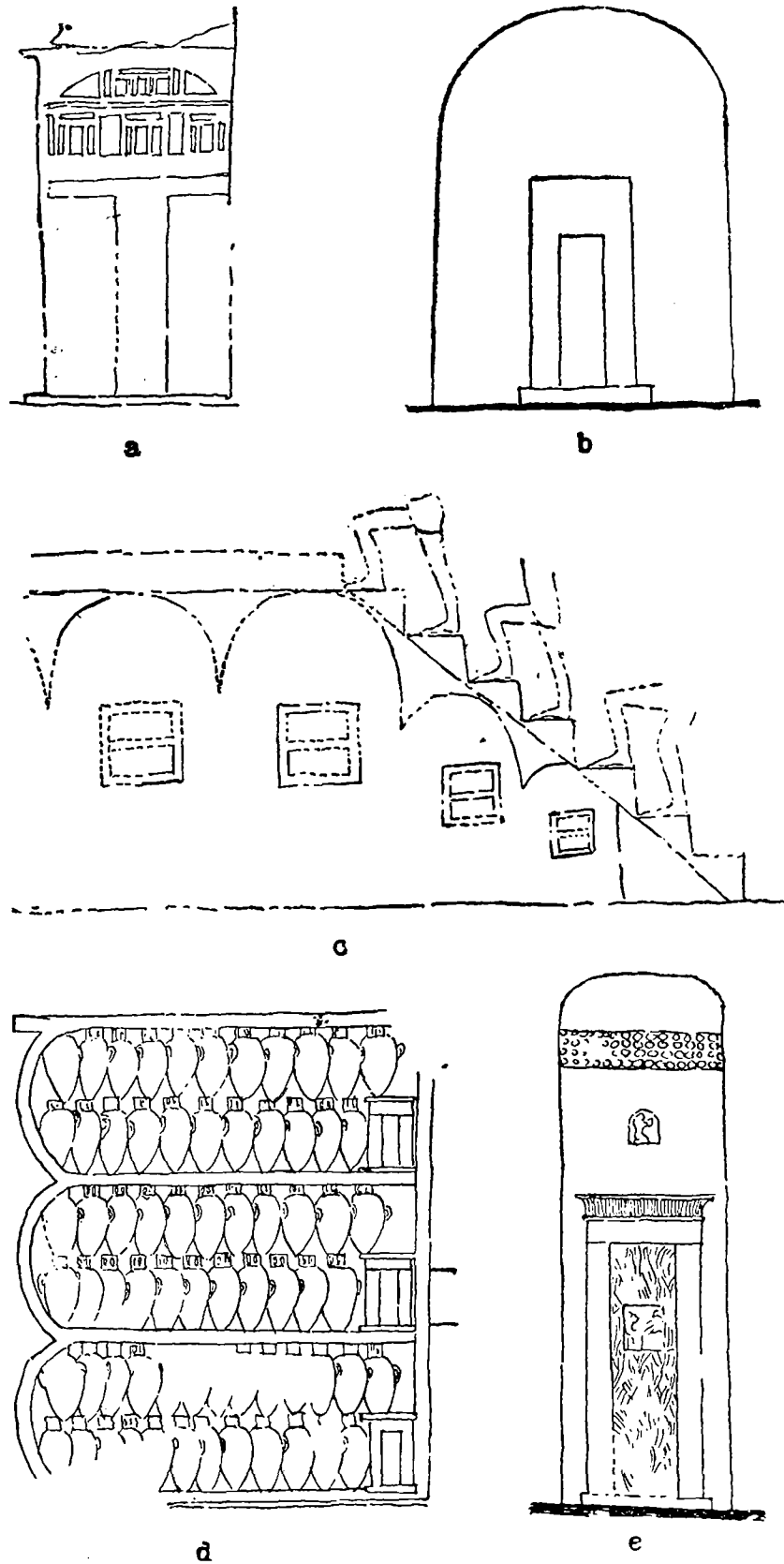


FIG. 108.—Representations of flat vaults in brickwork :

(a) Doorway (DAVIES, N. de G., "*The Townhouse in Ancient Egypt*", Fig. 1).

(b) Magazines in Amun Temple (NEWBERRY, P., "*Rekhmara*," Pl. XIV).

(c) Silos (DAVIES-GARDINER, "*The Tomb of Antefoker*", Pl. XV).

(d) Plan and section of magazines (DAVIES, N. de G., "*The Tombs of Menkheperasonb, Amenmose and another*", Pl. VIII).

(e) Tomb superstructure in the shape of a rounded stela (DAVIES, N. de G., "*The Tomb of Two Sculptors at Thebes*", Pl. XIX)

Besides, various Middle Kingdom models of brick houses show flat vaults and arches used in roofs and mulqafs⁽¹⁾. One of these has even ribs similar to those described (Fig. 109).

Flat brick vaults were used in Hellenistic times as is shown by beautifully preserved examples in the chapels at Hermopolis-West and Karanis⁽²⁾. The courses are inclined and the thickness is of two bricks, the lower placed as stretcher in the direction transversal to the axis of the vault, carrying a course of headers.



FIG. 109.—Model showing the ribs on the inside of the vault (PETRIE, W. F., "Gizeh and Rifeh", Pl. XX)

Coptic architecture⁽³⁾ and even modern local building craft⁽⁴⁾ exhibit a free use of the flat vault.

One may surmise that flat arches and vaults were as extensively used as barrel or catenary-curve ones, but being rather weaker they have survived only sporadically.

CATENARY-CURVE VAULTS

Vaults of the catenary or "sacred" curve occurred also in the excavations, not as beautifully intact as the flat vault of *Nfri*², but having interesting features, one being of the ribbed type, another with a reinforcing arch.

A long room was found covered with a partly preserved tunnel vault with ribs, similar to those of the archway of *Nfri*² in size, colour, and the feature of flat string at the springing of the curve. Structurally, however, the vault is quite different, the bricks being placed as stretchers with their long side transversal to the axis of the tunnel (Fig. 110).

This requires a different shape of the bricks. In fact, every semi-circular thickness of rib is formed of two adjacent bricks having their smallest side moulded into a quarter of a cylinder. The courses are inclined, the initial one leaning against the back wall of the tunnel, a method used to avoid centring in the ordinary simple catenary-curve vault. Such a disposition is known from other examples in the Minor Cemetery⁽⁵⁾. In *Sib.f's* tomb a barrel vault had such bricks interlocking. In another mastaba the rib is moulded in one of the medium sides of the brick⁽⁶⁾, shaped into a semi-circle.

All these sporadic ways of representing the same inner aspect of a ribbed vault point to the important fact that the architect knew no settled structural rule for the execution, but used his own creative ability. The aspect of the reeded roof was important, the method of obtaining it subsidiary.

(1) PETRIE, W. F., "Gizeh and Rifeh", 1907, Pls. XVI, XVII.

(2) BOACK-PATERSON, "Karanis", 1931.

(3) CLARKE, S., "Christian Antiquities in the Nile Valley", 1912.

(4) PETRIE, W. F., "Roman Ehnasya", 1905, Pl. LXXI, showing a modern cemetery surrounded with a wall having brick arches and false-doors.

(5) G. 2098, 3033, cf. FISHER, Cl. S., *op. cit.*, p. 65, Fig. 52; p. 106, Figs. 107-108.

(6) G. 3024, cf. FISHER, Cl. S., *op. cit.*, Figs. 105, 106.



FIG. 110.—Ribbed catenary vault at Giza

The excavations in the Mastaba of *Nfr-ihii* adjoining that of *Nfri* have brought to light the remains of a catenary-curved vault (Fig. 111). in the vestibule of the chapel. It displays the feature of a reinforcing arch in the middle of its length, springing flush from the wall, at about the same height as the vault itself, but being very likely of a lower curve, probably round or even flat. This arch shows a moulding semi-circular in section, beginning a little above the springing, from a rounded end. The aspect would have reproduced that of a curved reed projecting from the inner face of the arch. Here again only a direct transposition from a reed prototype could have led to this unique feature.

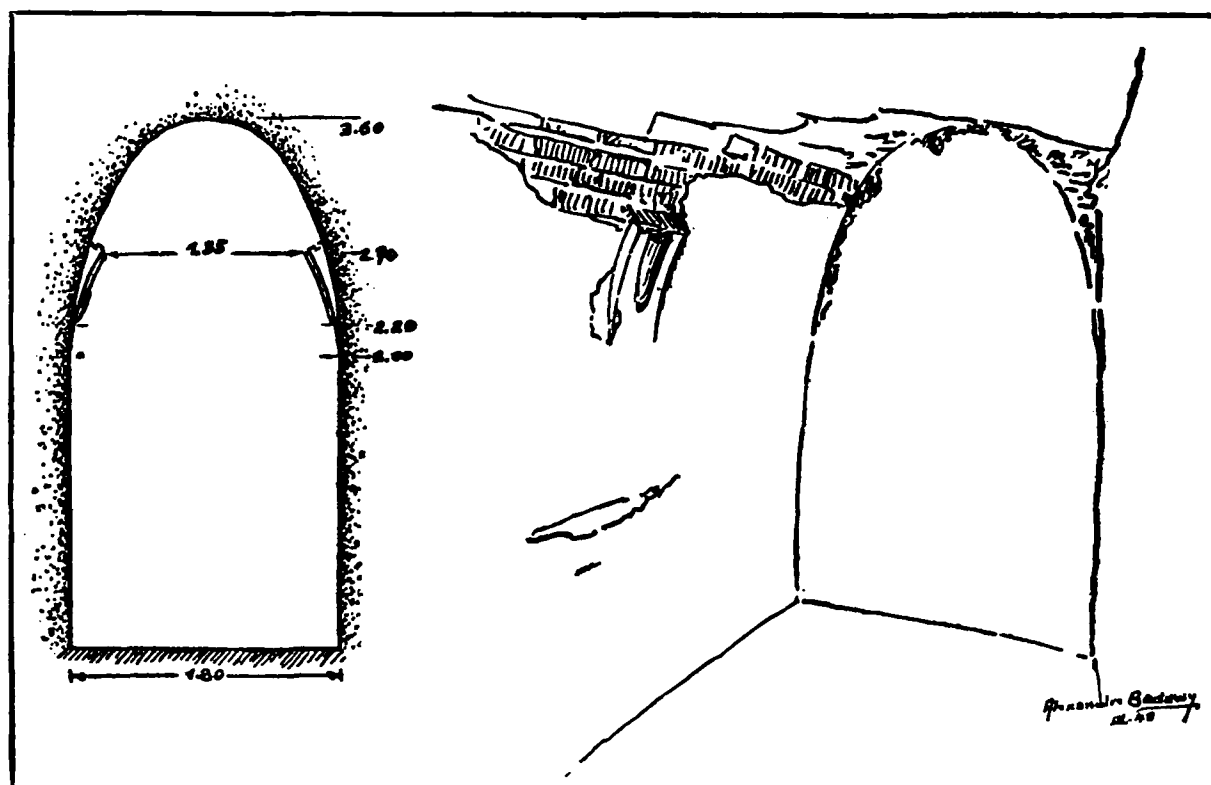


FIG. 111.—Catenary vault with reinforcing arch in the *Nfr-ihii* chapel

It is worth pointing out that the catenary-curve arch or vault is much less frequent in surviving buildings than the semi-circular or barrel ones, both in the representations and in the imitations in stone or rock-hewn constructions. Are we entitled by this to assure that the same infrequency applied to the total number of arches and vaults that were built? The flat curve could surely cover larger spans with a much more economical head. Thus we find a Middle Kingdom model representing a flat vault in the ground floor and a catenary-curve one on the first floor⁽¹⁾. Being more stable on account of less inner tension stresses, this type has survived more easily in existing examples in the Giza Necropolis (Tombs of *shij-htpw*) (Fig. 112); Seneb, . . . (Fig. 113) and elsewhere.

(1) PETRIE, W. F., "Gizeh and Bifeh", Pl. XX, No. 64.

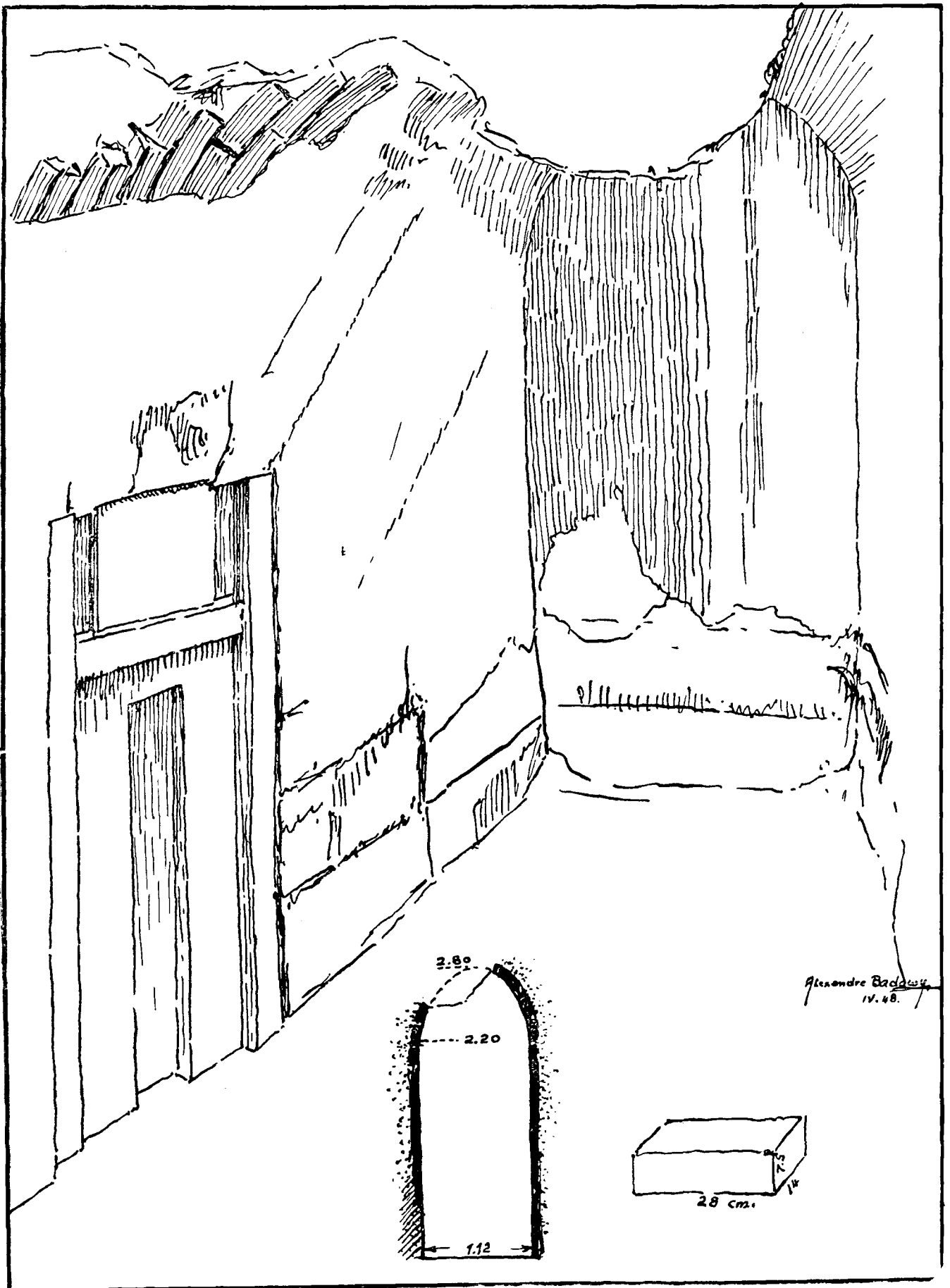


FIG. 112.—Simple catenary vault of *3htj-htpw*

DOMES

No intact brick dome was discovered this season, but only what appears very probably to be the springing of such a covering. This occurs over a small room (serdab ?), square in plan, in the shape of small roundings corbelling at the corners of the walls. More substantial remains

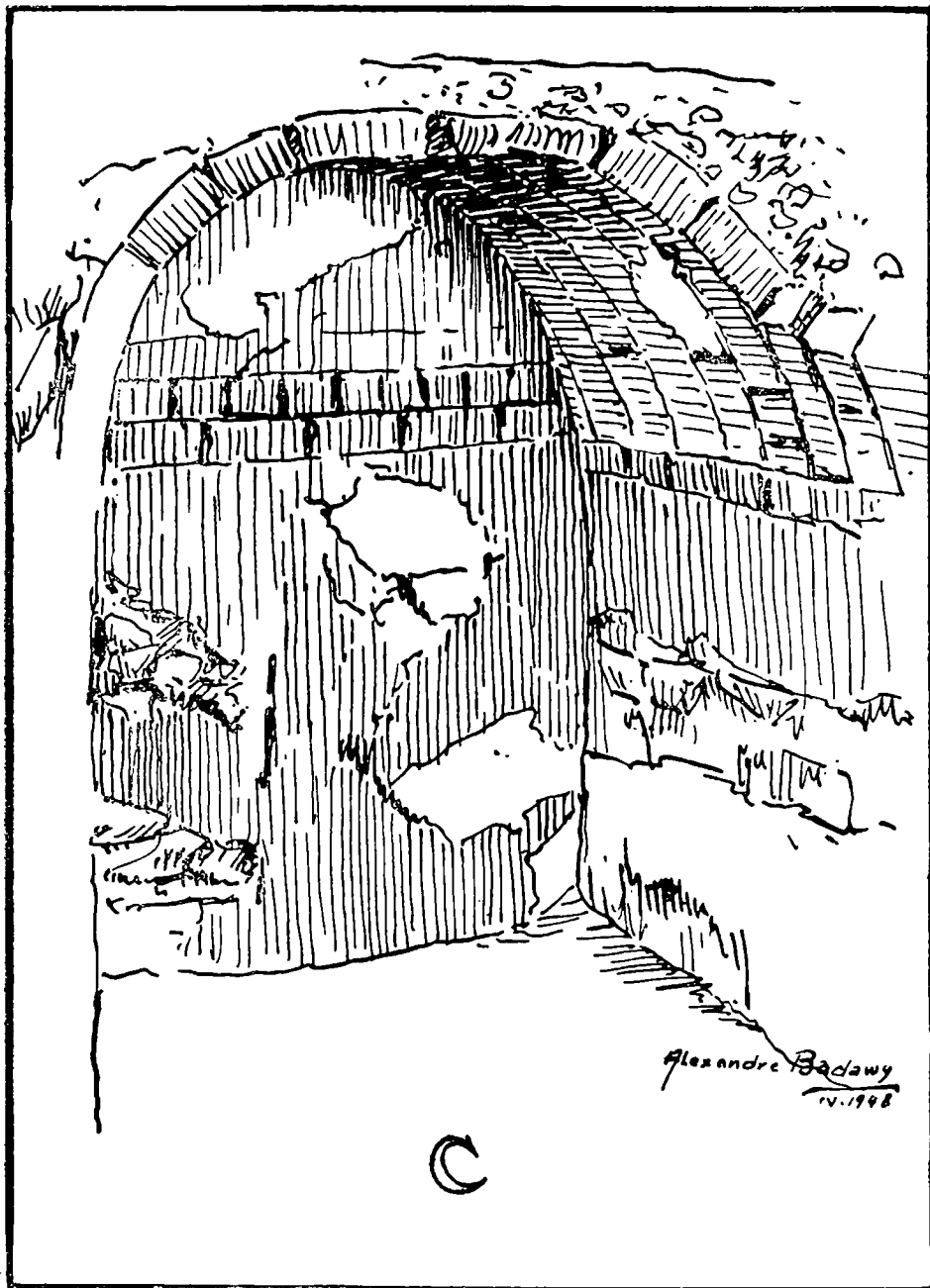


FIG. 113.—Simple catenary vault of Seneb

are known in Seneb's tomb (Fig. 114) at Giza, discovered some time ago by Professor H. Junker. The method of construction is not clear: it seems that the courses of stretchers are somewhat tilted and grow in narrower circles as the height increases, forming corbelling courses. The section of the dome appears to be a flat semi-circle.

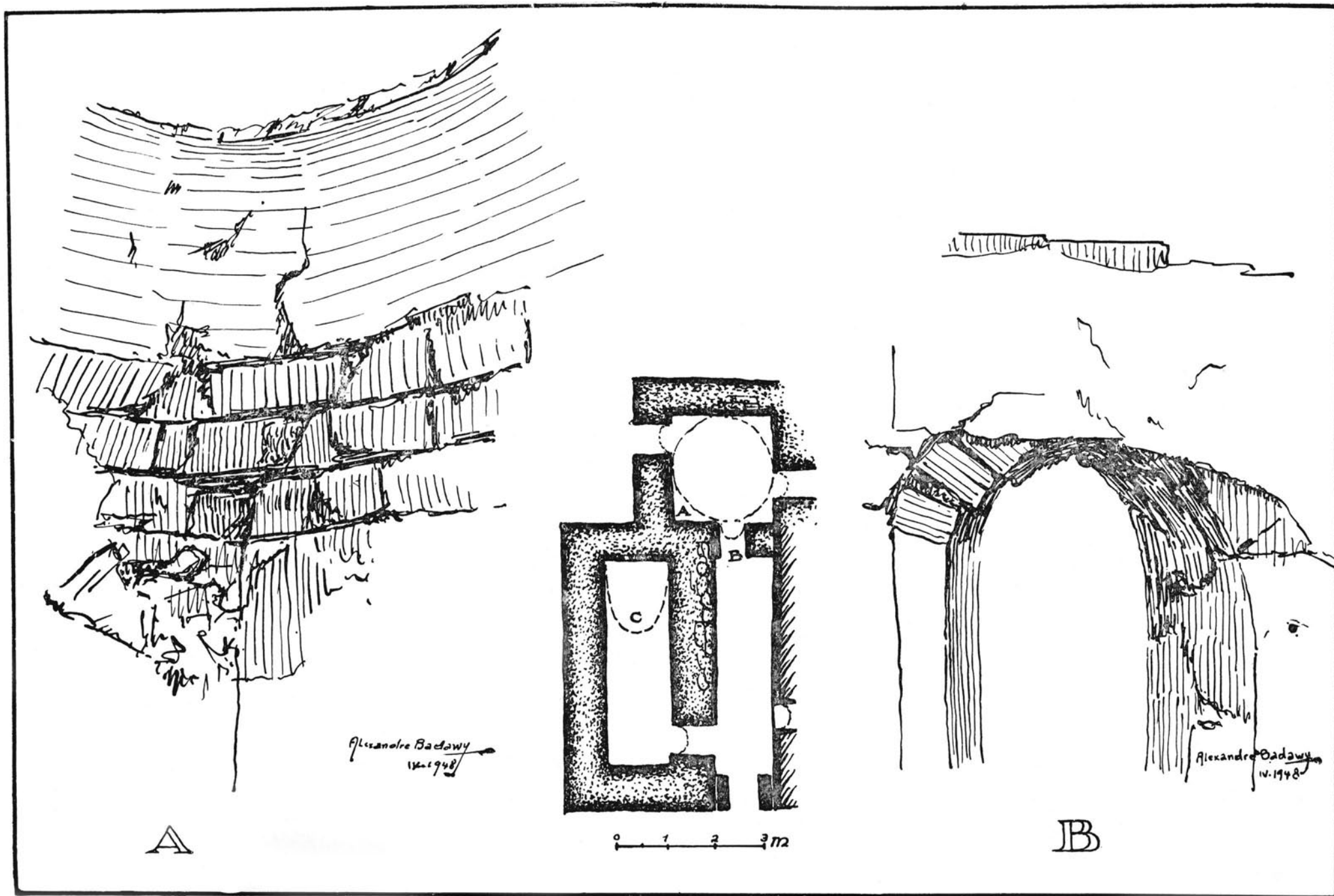


FIG. 114.—Sketch-plan of Seneb's chapel, north-eastern pendentive of the cupola and arched doorway (B)

Representations of reed domes are known from the earliest times (Fig. 115). They are shown covering huts, sanctuaries or silos and are flat-shaped. Later these structures were copied in brickwork as is shown by scenes of silos and in the superstructures of tombs, as coverings of doorways or of pylon towers (Fig. 116).

Models of Middle Kingdom houses illustrate the use of brickwork domes or cupolas (¹). Such elements appear also inside the superstructures of Middle Kingdom tombs and in the Meroitic pyramids.

Small cupolas were found over small chambers or kilns (²). Tombs at Abydos and Deir el-Bahari made use in the interior rooms of their superstructures of domes of ogival section built of horizontal rings corbelling one above the other (³).

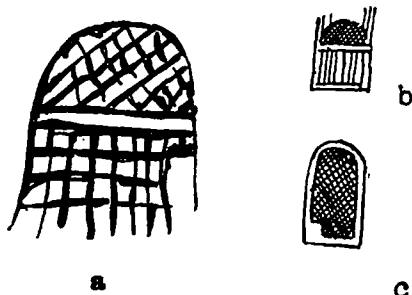


FIG. 115.—Representations of domes :

- (a) Archaic round hut (PETRIE, W. F., "*Royal Tombs*", II, Pl. IV, 11),
 (b) Archaic hut with four corner-posts (LEGGE, "*The carved slates from Hierakonpolis*", P.S.B.A., XXII, Pl. II).
 (c) Hieroglyph showing the elevation of a silo in light materials (JUNKER, H., "*Giza*", III).

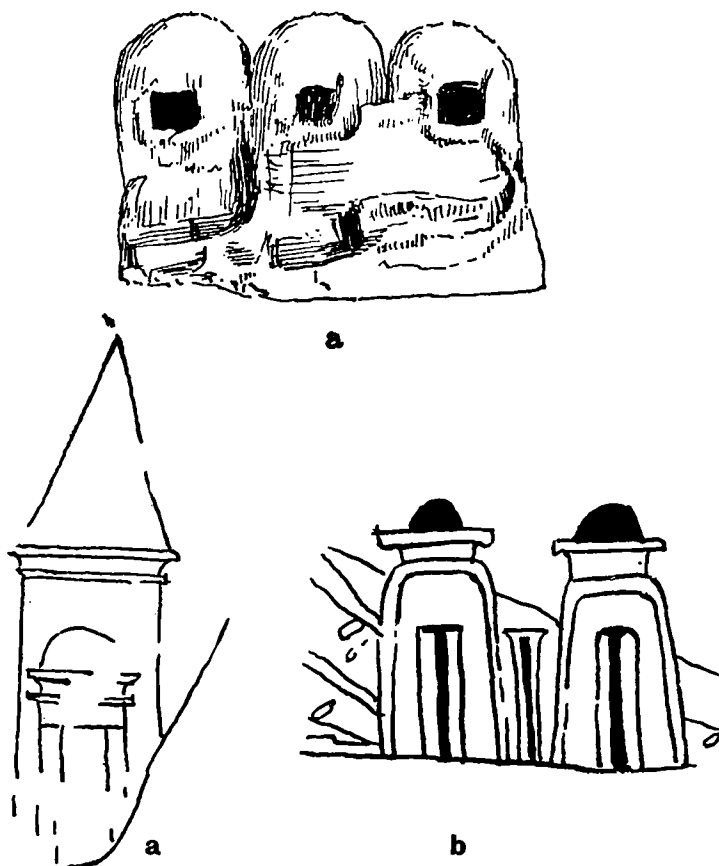


FIG. 116.—Representations of brick cupolas :

- (a) Model of domed silos (WRZSZINSKI, W., "*Atlas*", 60 b).
 (b) Cupola on porch (DAVIES, N. M., *J.E.A.*, XXIV, p. 39, No. 30).
 (c) Cupolas on pylon towers (WRZSZINSKI, W., "*Atlas*", I, 417).

The remains of the covering over the small quadrangular room in *Nfri's* mastaba, together with the well-preserved dome of Seneb, appear to be the only surviving Old Kingdom attempts to cover a square plan with a cupola, using (pendentives ?) (⁴). A tomb of the New Kingdom offers an example of similar elements.

(¹) PETRIE, W. F., *op cit.*, Pl. XVIII.

(²) CLARKE-ENGELBACH, "*Ancient Egyptian Masonry*", 1930, pp. 184-185.

(³) CHOISY, A., "*L'Art de bâtir chez les Egyptiens*", 1904, pp. 49-50.

(⁴) PIERON, H., "*Un tombeau égyptien à coupole sur pendentif*". Also PETRIE, W. F., "*Egyptian Architecture*", 1938, p. 73.

The Hellenistic necropolis of Hermopolis-West has a number of cupolas starting at the corners with inclined courses which form a kind of pendentive. Inclined courses rising from the four corners meet along the axes of the room, at right angles (1).



This seems to be the same method of construction adopted by the Copts in the flat cupolas covering their earliest buildings (Deir el-Ahmar at Sohâg) (2).

* * *

This brief survey of the occurrence of brick vaults and domes since the earliest times in reed architecture and their transposition into brickwork, later copied in stonework, shows the precedence of this kind of covering over others using wooden logs or beams.

The flat-curved arch and vault represented in archaic drawings is now known to have survived in Old Kingdom architecture on a scale hitherto unsuspected. The curve occurred in nature: it is the one shown by a papyrus stalk bending under the combined weight of a bird's nest and a predatory ichneumon, by bundles of reeds carried by dwellers in the marshes or imitated in papyrus boats (3).

The method of tracing the curve as stylized by architects seems to have been very close to that for a three-centred arch. In the arch or vault of *Nfri*, some kind of centring must have been used, both internal and external faces being open and the span being rather extensive.

That the architects of the Old Kingdom should have attached such importance to the reproductions of features unrelated to brickwork and by no means only decorative, shows that those had been outstanding in the original architecture. These ribs are clearly transposed from bundles of reeds or pliable stalks. Pompeian red must have reproduced the colour of such materials when dry. Similar "ribs" were known in flat stone ceilings of the earliest period, as in the tombs of Hemaka, Hor-Aha, the Deser pyramid complex at Saqqara and a tomb at Helwan-North. They are coloured the same red as the curved ribs of the Giza vaults. There is accordingly no ground for surmising a wooden origin for the so-called imitations of "logs" or "beams" in stone ceilings. There is much more likelihood that they too are imitations of bundles of reeds, used in horizontal coverings, either in flat ceilings or in the irregular vault peculiar to Egyptian architecture , evolved out of the animal-shaped hut of archaic times  (4). Such a light ceiling of bundles of reeds would have been quite adequate to a light structure of reeds and mats (5), which formed the usual type of early archaic architecture.

(1) BADAWY, ALEXANDRE, "L'architecture et la décoration Hellénistiques à Hermoupolis-Ouest", 1940, Fig. 22, p. 34. *du manuscrit (non publié)*.

(2) PETRIE, W. F., "Egyptian Architecture", 1938, Fig. 122.

(3) DAVIES, N. de G., "The Rock Tombs of Sheikh Said", 1901, Pls. XI, XII.

(4) BADAWY, ALEXANDRE, "Le dessin architectural chez les Anciens Egyptiens", 1948, pp. 18-22, 33-37.

(5) This solves the difficulty encountered by LAUER, PH., "Etudes complémentaires sur les monuments du roi Zoser à Saqqarah", *Supplément aux A.S.A.*, 1938, pp. 41, 66.

The Pompeian red colouring, which has been considered as denoting a wooden origin for the "fluted" columns of the Deser pyramid complex, is now known for certain to be a rendering of the colour of dried pliable stalks.

The theory that these columns imitated a wooden prototype, either directly or through an intermediate wooden stage ⁽¹⁾, is deprived of its strongest support. Such an intermediate stage is henceforth not to be taken into account. The colouring of the fluted columns of Deser can be understood as reproducing that of the prototype: black for a lower plinth of mud daub, white for a string fillet of binding, either cord or leather, and the upper red for the natural hue of dried stalks.

Wooden architecture seems rather to be receding into the background. So is the theory of a sedentary architecture of mud and brick in Lower Egypt and Upper Egypt (?) a nomad architecture using light wood and wattle-and-daub materials ⁽²⁾. Such a view would suppose an abnormal evolution of architecture in this country, regardless of the natural influences of soil and climate, both vital in the history of any architecture. Upper Egypt must have dried up long before Lower Egypt, which was still in historical times covered with marshes. One would have more readily understood an inverse development, of sedentary architecture, featured by stable structures of brick on the dry soil of Upper Egypt, and nomad or light buildings made of stalks of plants growing freely in the Delta marshes. Such was at any rate the case in the earliest period at Ur.

According to the documentary evidence reviewed, vaults and domes were copied directly from structures in light materials: pictures show types of flat and catenary-curve vaults, and domes on circular or square plans, while the ever growing corpus of archaic and Old Kingdom remains give reproductions of these featuring elements of vaults such as reed ribs, which have lost their original structural value and are rather difficult to transpose into brick or stone.

The miracle that was Egyptian architecture seems to have had only restricted recourse to wood and its style as well as its elements were mostly directly inspired from the early use of light plant materials.

⁽¹⁾ cf. LAUBER, PH.: *op. cit.*, pp. 41-42,69, citing RICKE, H., "*Bemerkungen zur ägyptische Baukunst des Alten Reiches*", I 1944
But see: BADAWY, ALEXANDRE. "*La première architecture en Égypte*", A.S.A., T. LI, 1951, pp. 1-28.

⁽²⁾ Propounded by R.

[This page is intentionally blank.]

INDEX OF TITLES

Q i



imshw-hr-ntr-'s

The Honoured by the Great God,
pp. 1, 69

imshw-hr-nb-f

The Honoured by his Lord, p. 69

imshyt hr hjj-s

The Honoured by her Husband,
p. 69

imshw

The Honoured One, p. 69

imj-rs-sr.w

Overseer of the (Judicial) Officials
p. 1

imj-rs-pr.w-msw-njswt

Overseer of the Houses of the Royal
Children, p. 31

imj-rs-gs-pr-rsw

Director of the Mercenary Guard,
p. 39

imj-rs-pr

The Director of the House, pp. 69, 103

imj-rs ht-'s.t

The Director of the Great House,
p. 69

imj-rs hs

Overseer of the Measurers, p. 87

imj-rs-hm.w-ks

Overseer of the *Ka*-priests, p. 103

imj-rs-hmw

Overseer of the Carpenters, p. 121

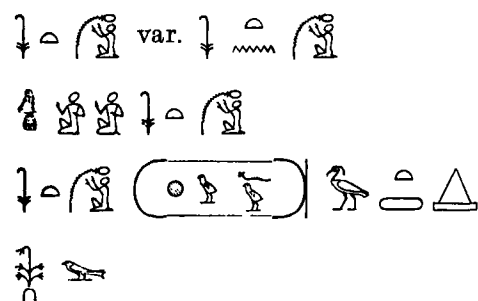
irj-ht-pr-'s

The Overseer of the Property of the
Palace, p. 39

rh-njswt

Royal Acquaintance, pp. 1, 11, 31,
39, 69, 121, etc.

W w



w'b-njswt

Royal *W'b*-priest, pp. 12, 31, 39, 69

w'b-msw-njswt

The *W'b*-priest of the King's Sons,
p. 31

w'b-njswtsh-Hwfw

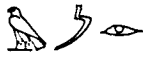
King's *W'b*-priest of the Pyramid
sh-Hwfw, p. 39

wr-md-'s'm'

The Great One of the Ten of Upper
Egypt, p. 1

 **m**
*mītrt*

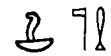

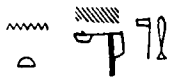
Concubine, p. 11

*mss-Hr*

The One who sees the King (?), p. 39

 **n**
*nb. i'msh-hr-ntr*Possessor of Honour with the God,
p. 39*nb. i'mshw-hr-ntr-'s*Possessor of Honour with the Great
God, pp. 11, 31, 103*nb.t i'msh hr ntr*Possessor of Honour with the God,
p. 31
 **h**
*hm-k3*

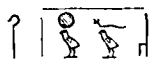
Ka-priest, pp. 12, 103

*hm-ntr-Hwfw*Priest of *Hwfw*, p. 1*hm-ntr-Hnt-šht-Hwfw*Priest of the (vestibule) of the Pyramid
šht-Hwfw, p. 11*hm-ntr-Wadjt*Priest of the Goddess *Wadjt*, p. 39,
var. , p. 66*hm.t-ntr-Neith*Priestess of *Neith*, p. 69*hm.t-ntr-Ht.Hr*Priestess of *Hathor*, p. 69*hk3-ht*

Regent of the Castle, pp. 1, 39

*hk3-ht.'s.t*

Regent of the Great Castle, p. 39

*hk3-Ht-Hwfw*Regent of the Castle of *Hwfw*, p. 11

⊖ h
⊖ h

hrp-m-s3

hntj-nst

hrp-'prw

hrp-'prw-nfrw

Director of the Members of a Phyle,
p. 1

The One in Front of the Throne, p. 1

Commander of a Company, p. 39

Commander of a Company of Recruits,
p. 39

∩ s

shd-w'bw-3ht-hwfw

shd-hmw-ntr

shd-w'bw

shd-wi3

shd-Pr-'3

shd-hm w-pr-w'b

sm3w-pr

ss'

s3b-nht-hrw

s3b-hrj-skr

ss'-ht-'st

ss'-njwt-m3wt-Ht 'st

sh

Inspector of *W'b*-priests of the
Pyramid *3ht-Hwfw*, p. 1

Inspector of the Priests, p. 1

Inspector of *W'b*-priests, p. 11

Inspector of the (Royal) Boat, p. 39

Inspector of the Great Palace, p. 39

Inspector of Artisans of the *W'bt*-
workshop, p. 121

Elder of the House, p. 12

Scribe, pp. 11, 69

Judge, Powerful of Voice, p. 95

Judge and Chief of Police, p. 39

The Scribe of the Great House, p. 69

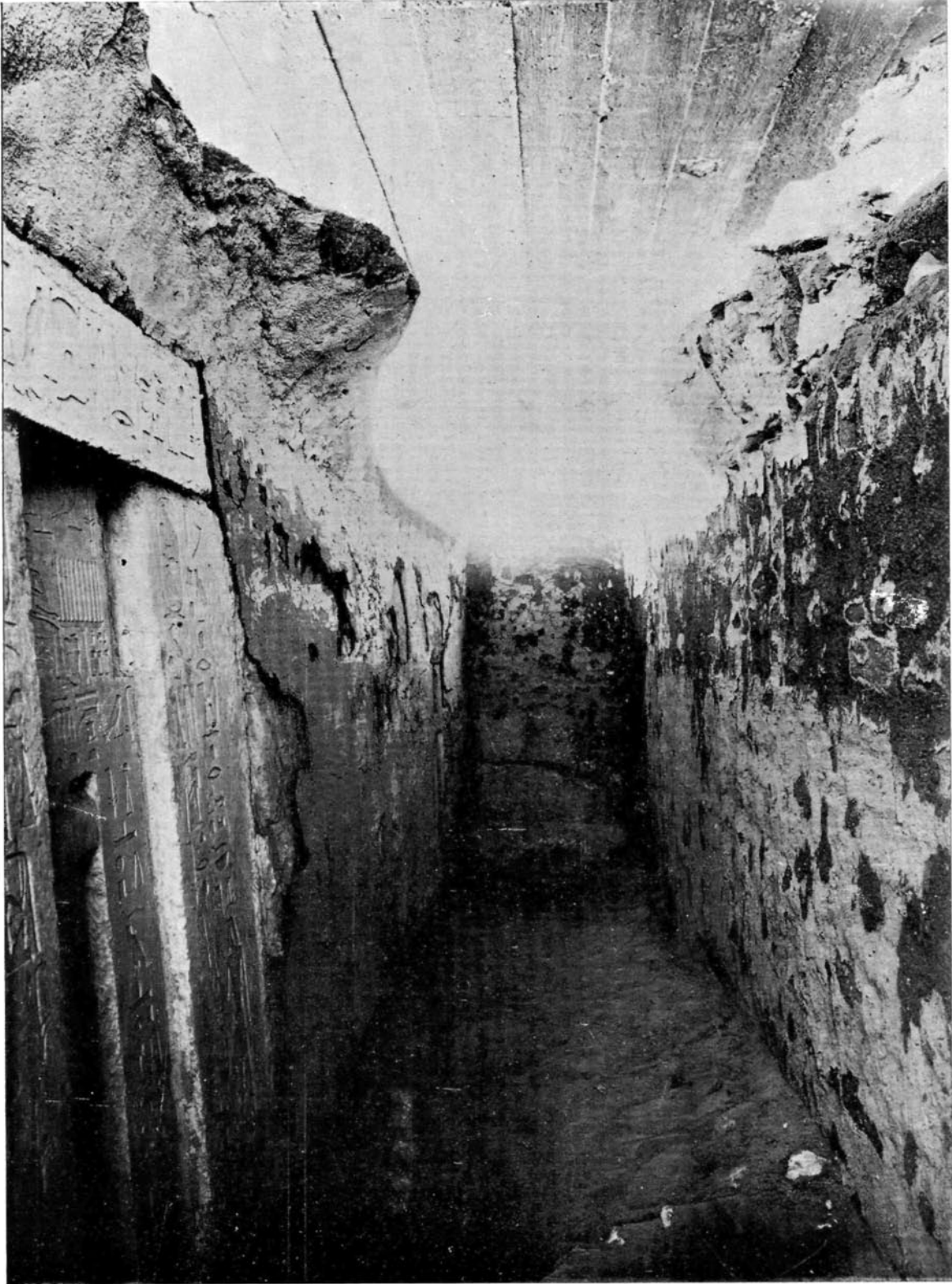
The Scribe of the New Cities of the
Great House, p. 69

(?), p. 95

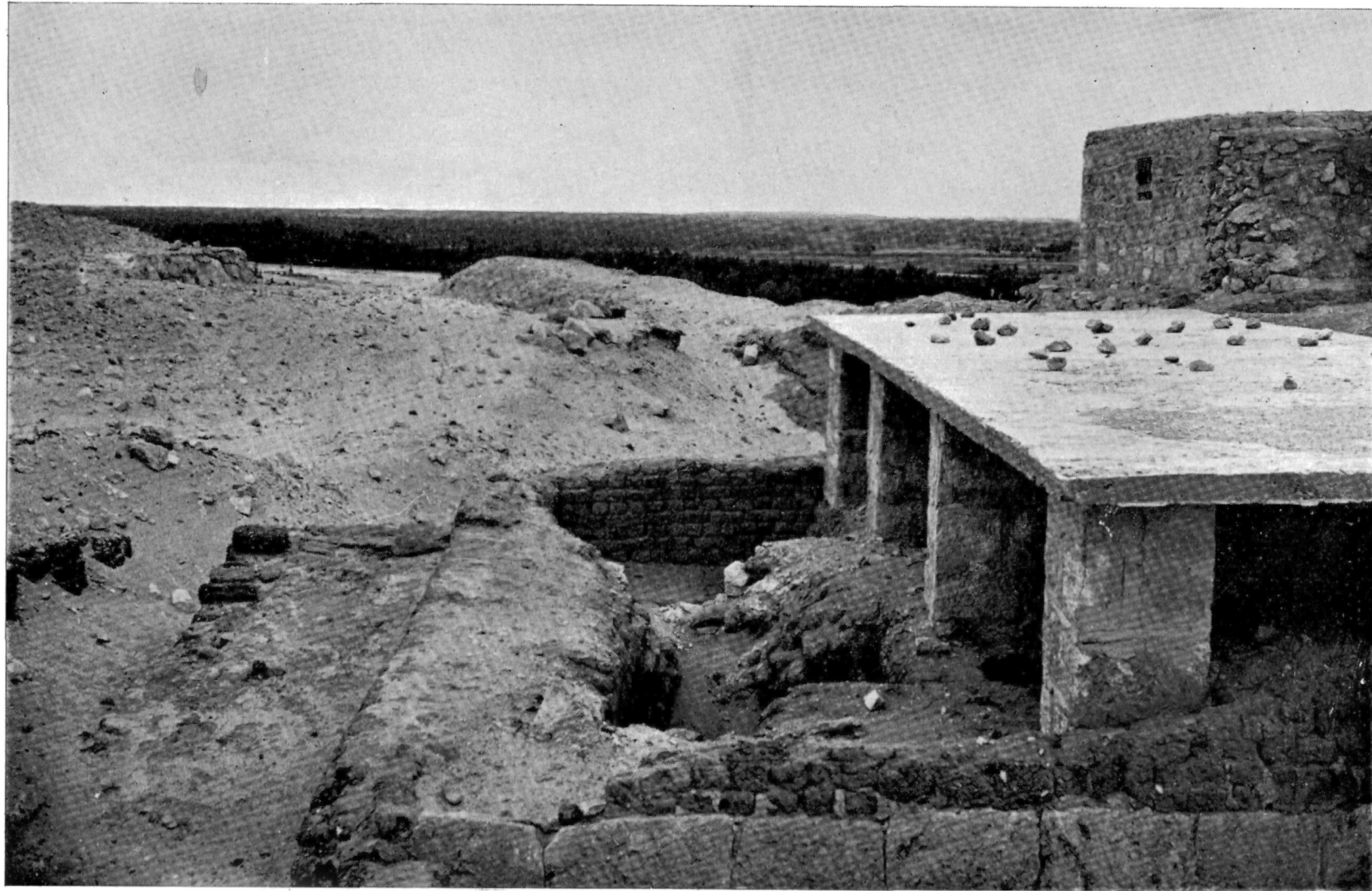
PLATES



Steps, court and entrance to the chapel



Chapel with the remaining parts of the vault



The western side of the mastaba with the ramp



Southern false-door

B



A



Two canopic jars found in Shaft No. 1

Northern false-door



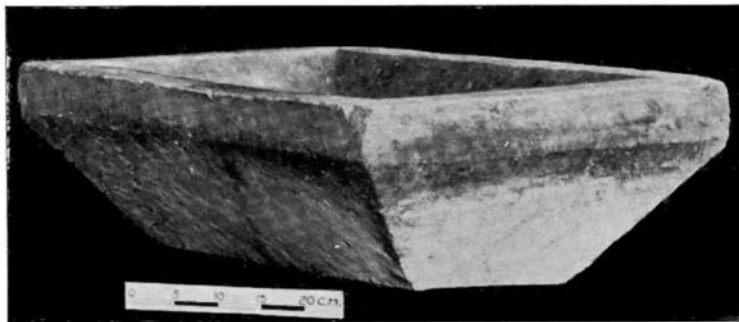
General view—east side

A



Drum above the entrance

B



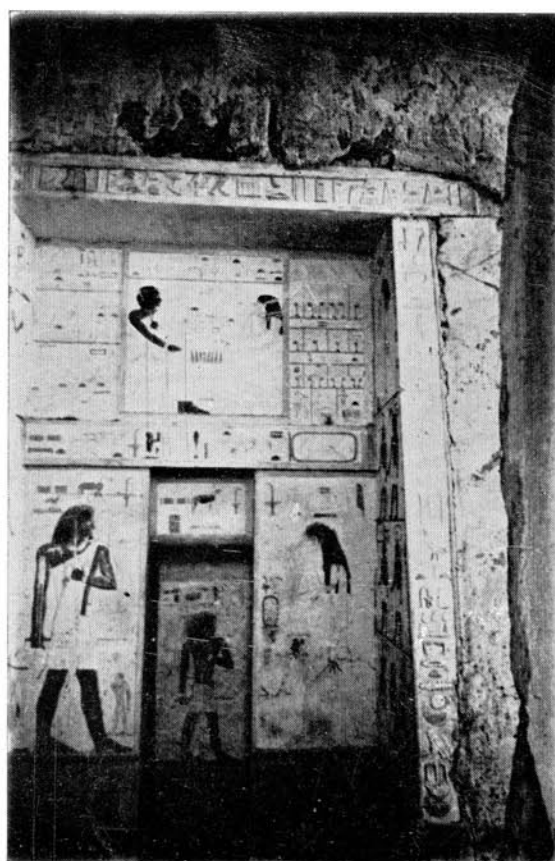
Offering-table in front of the false door

A



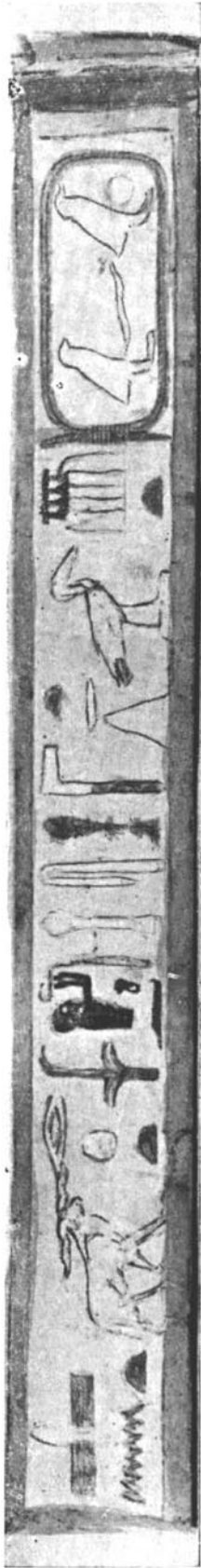
Upper part of the false-door

B



False-door

A

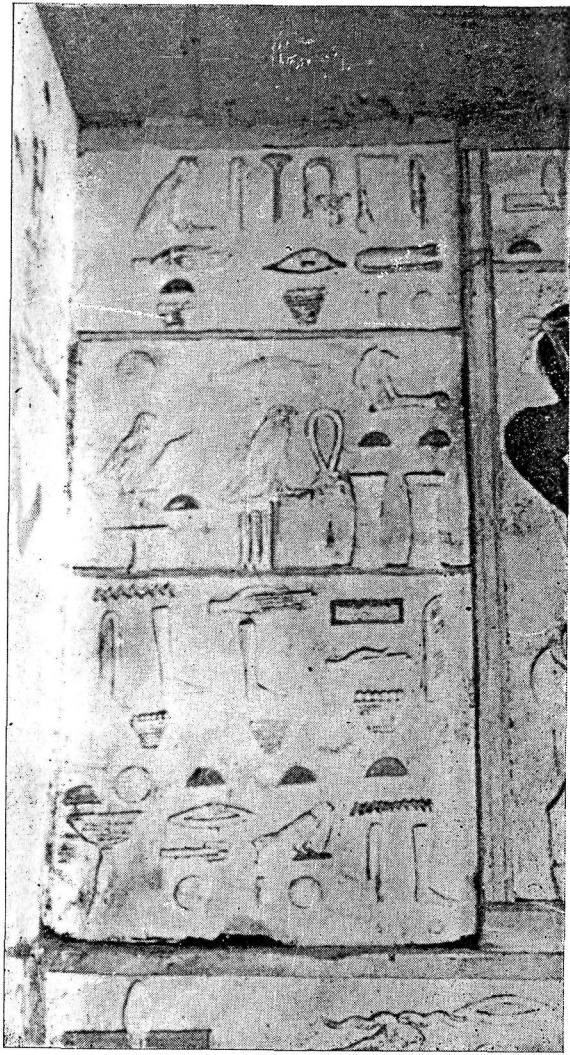


Upper lintel

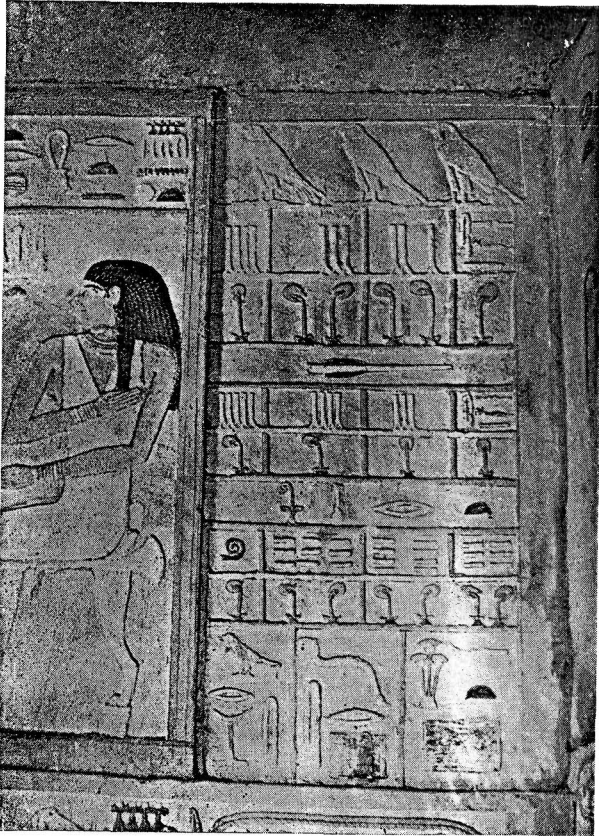
B



Middle part of the tablet



Left side of the tablet

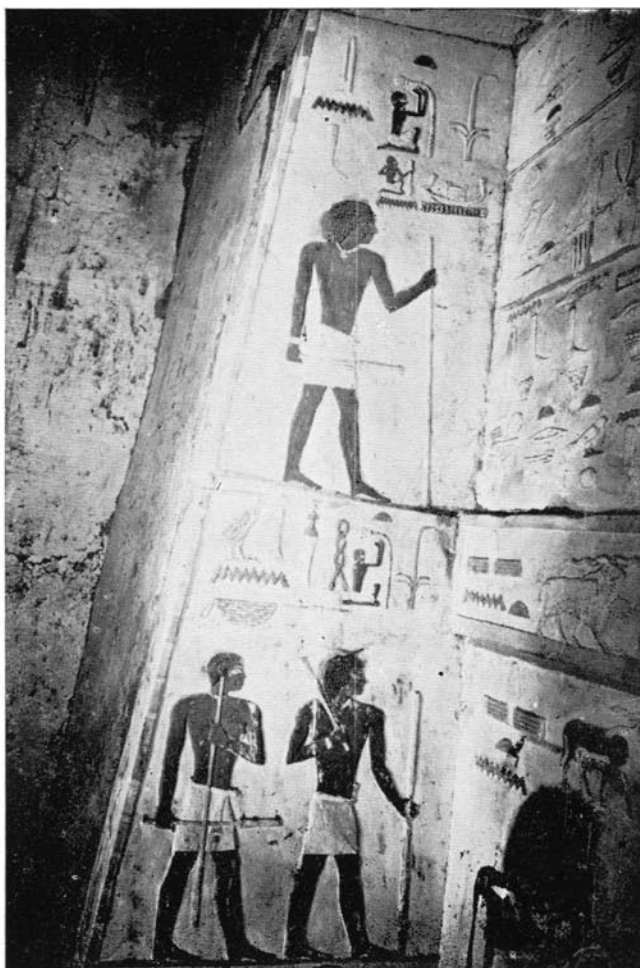


Right side of the tablet

B



Right-hand outer jamb



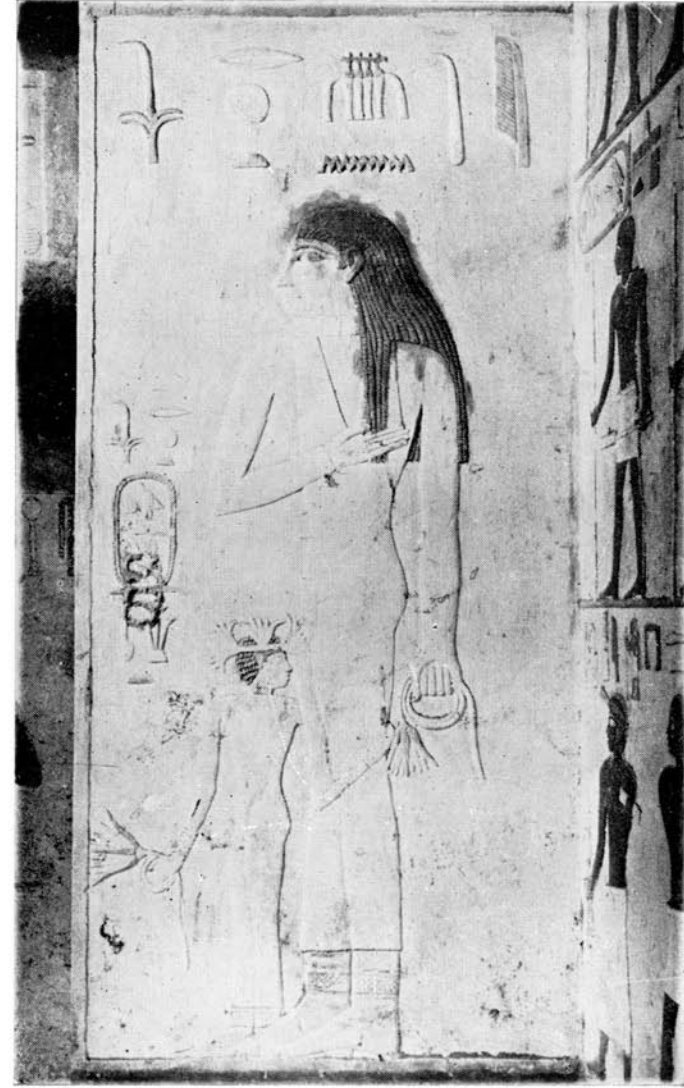
Left-hand outer jamb

A



Left door jamb of the recess

B



Right door jamb of the recess



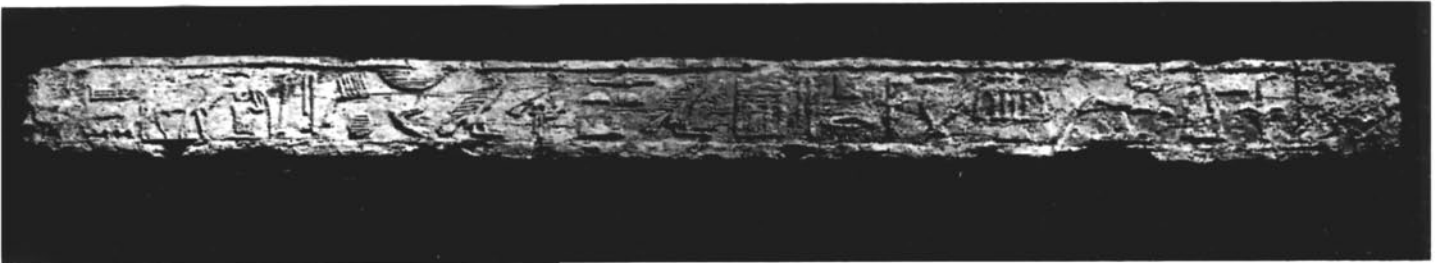
Inner panel of the recess

A



Drum of Khenti

B



Lintel of *Ni-htp-hnmw*

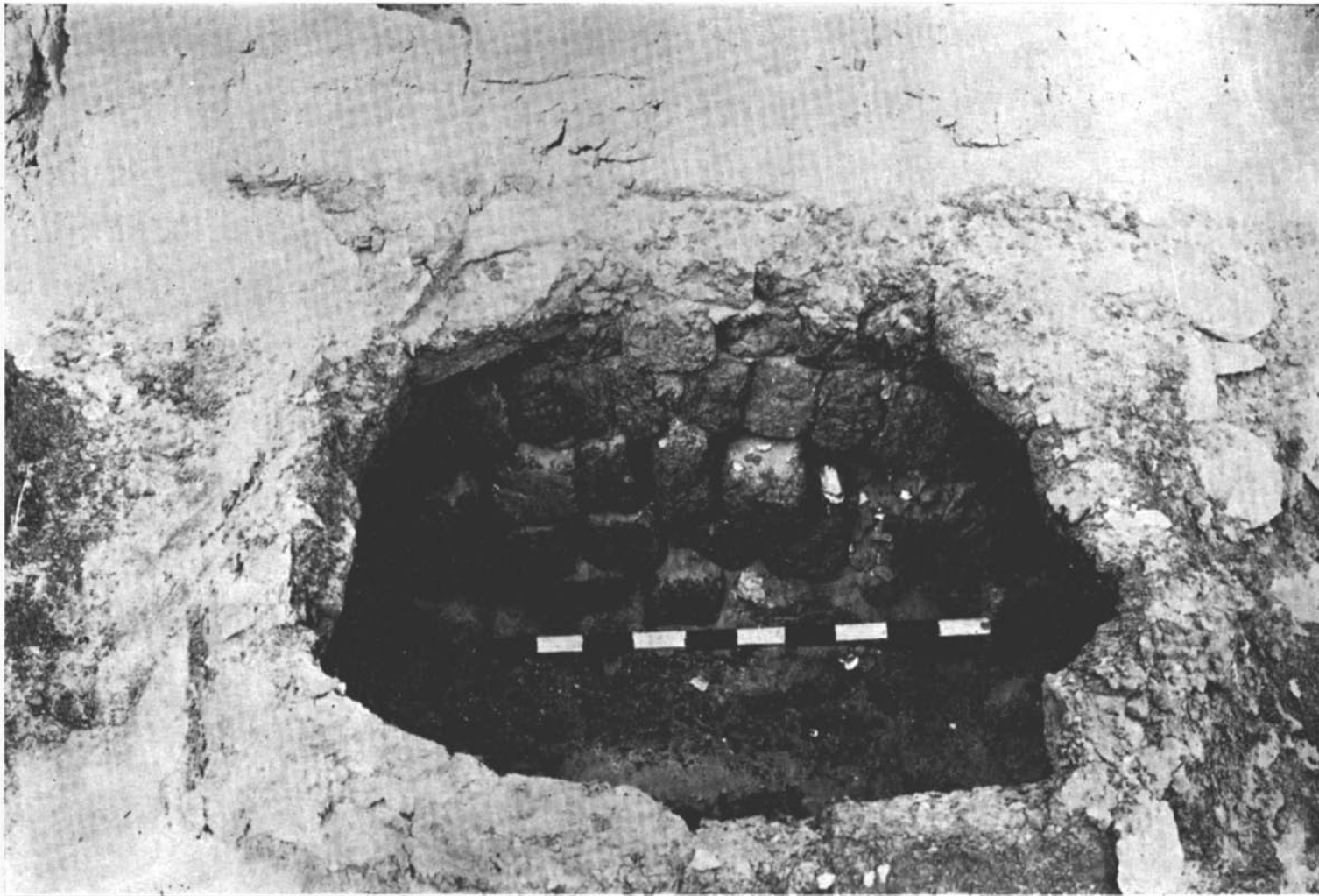
C



Drum of *Ni-htp-hnmw*



General view—east side



Vaulted room



A

Chapel with part of the vaulted roof



B

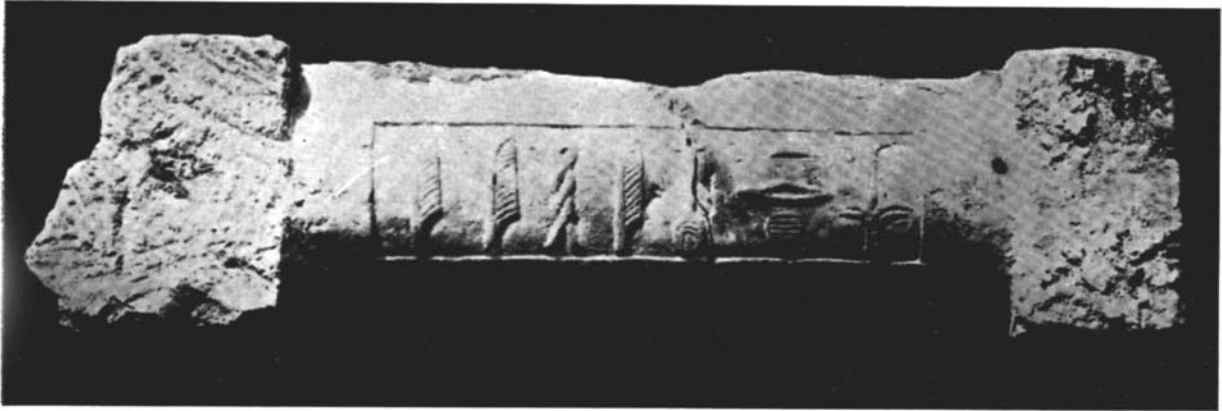
Lintel and drum in limestone

A



Lintel of Spn

B



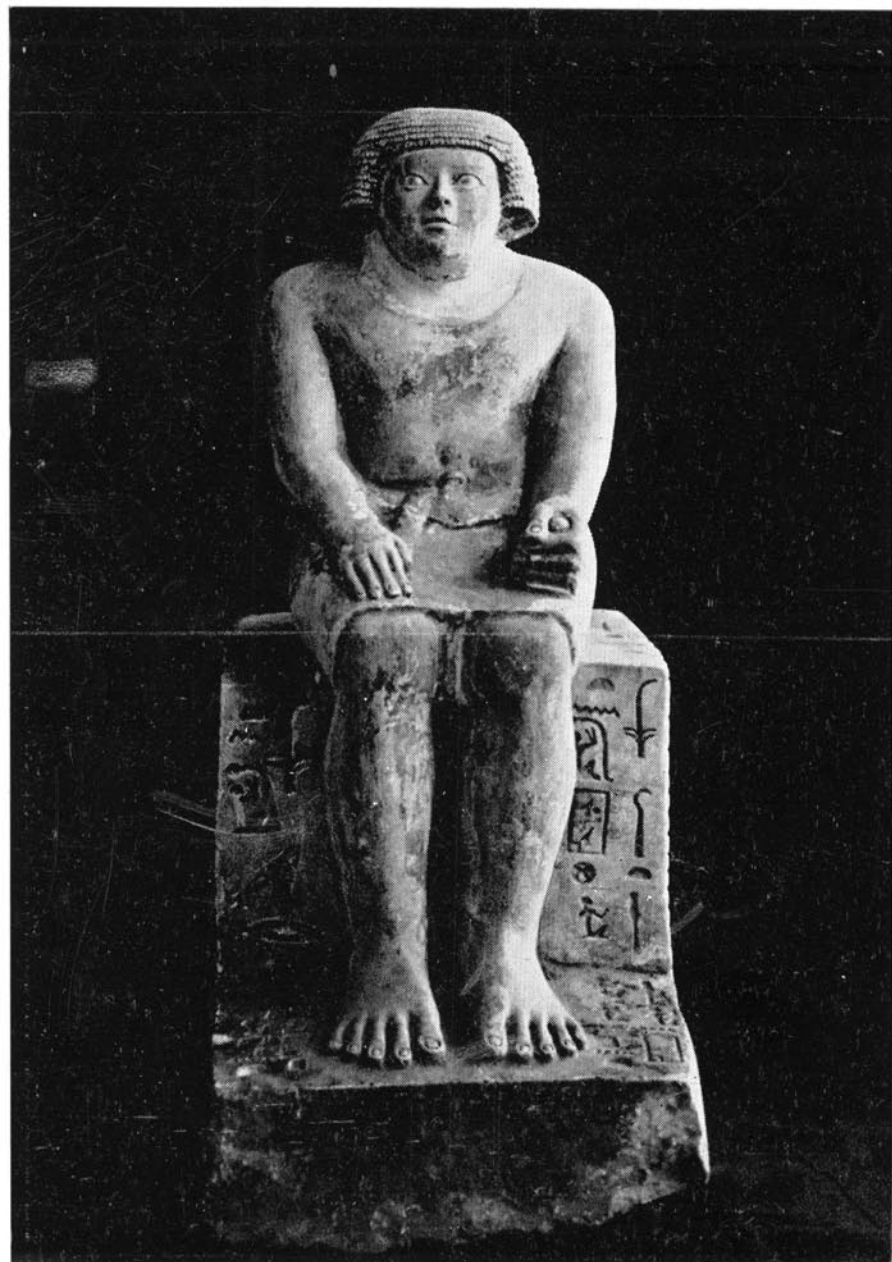
Drum of *Nfr-ihii*

C

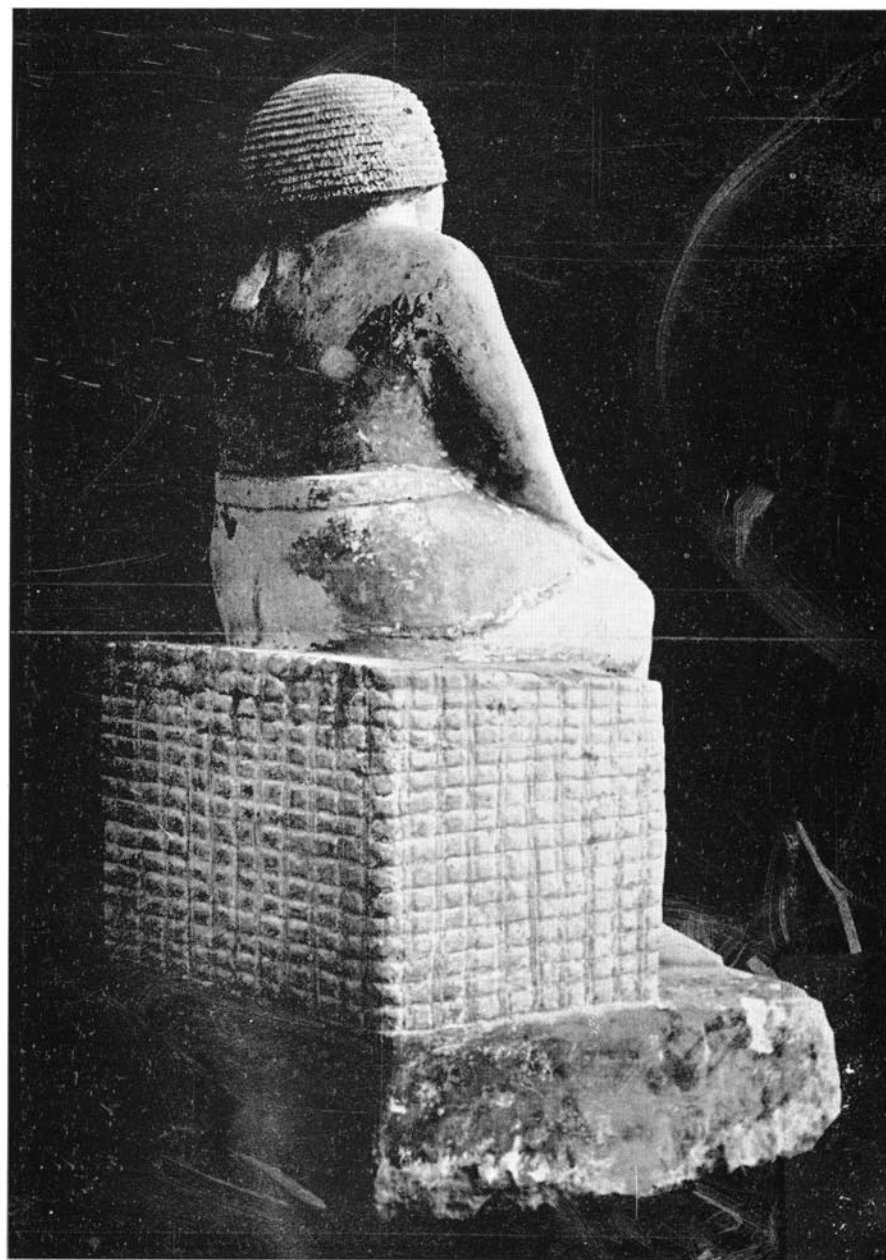


Statues in situ

A



B



Statue of Spn

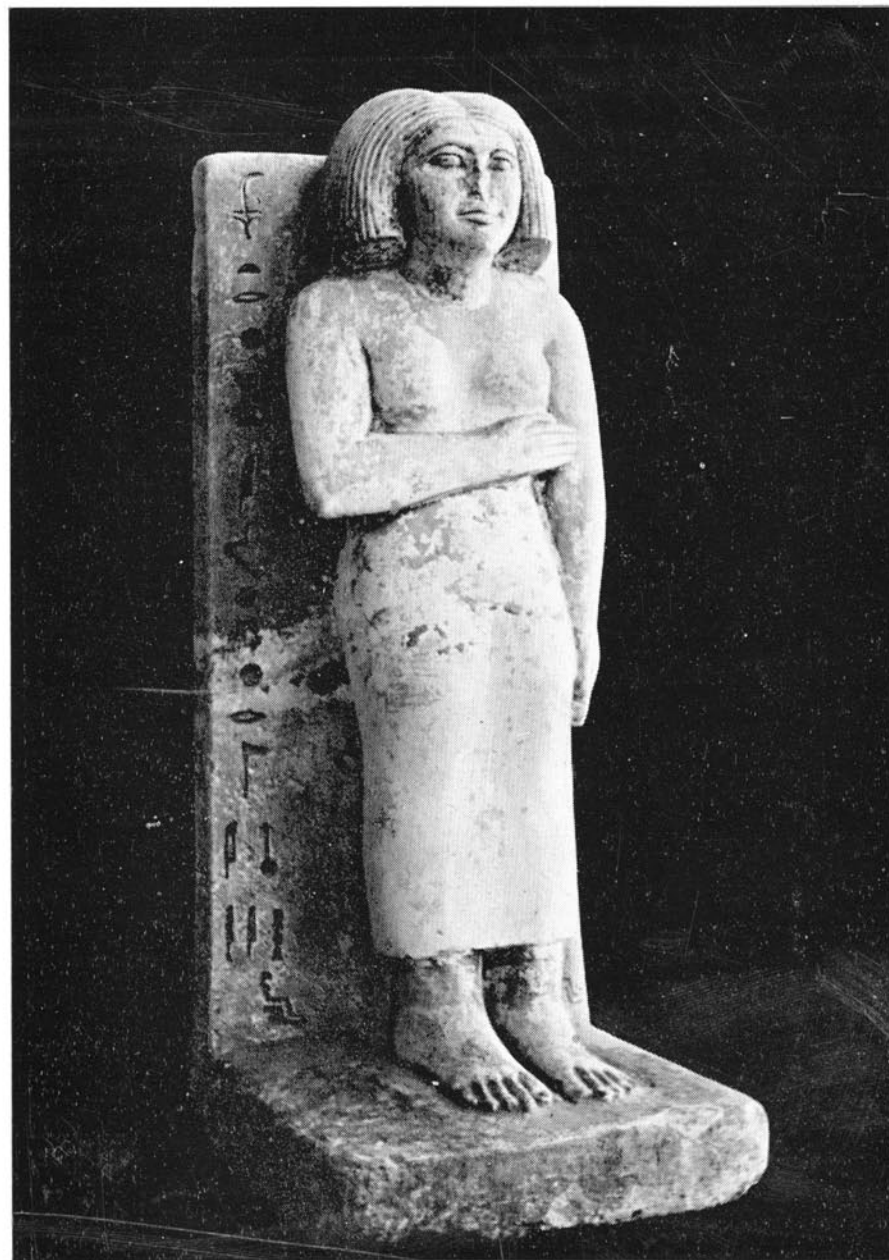
THE MASTABA OF *Nfr-ibn*

Pl. XX

A



B



First statue of Nfr-ihii

A



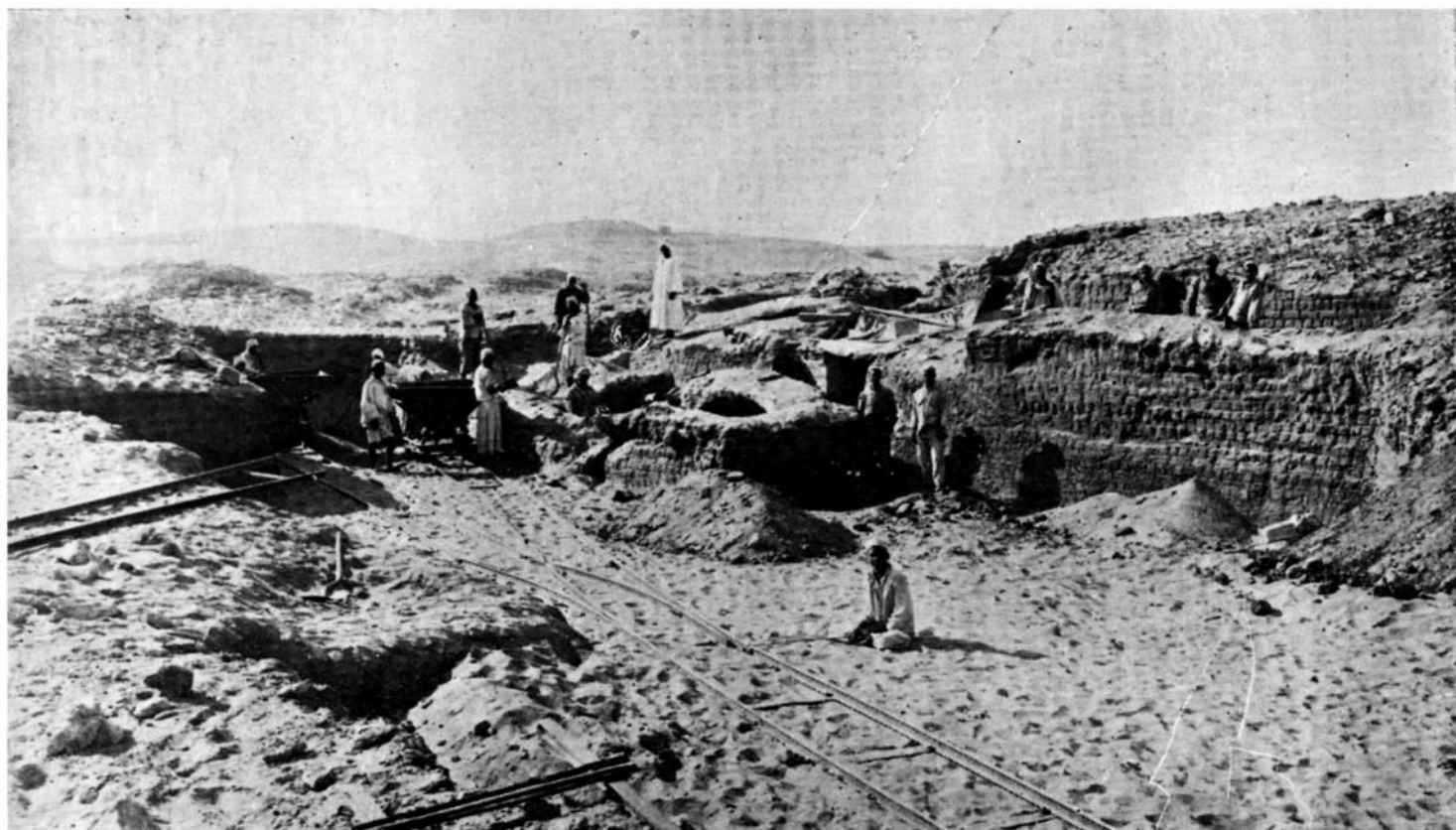
B



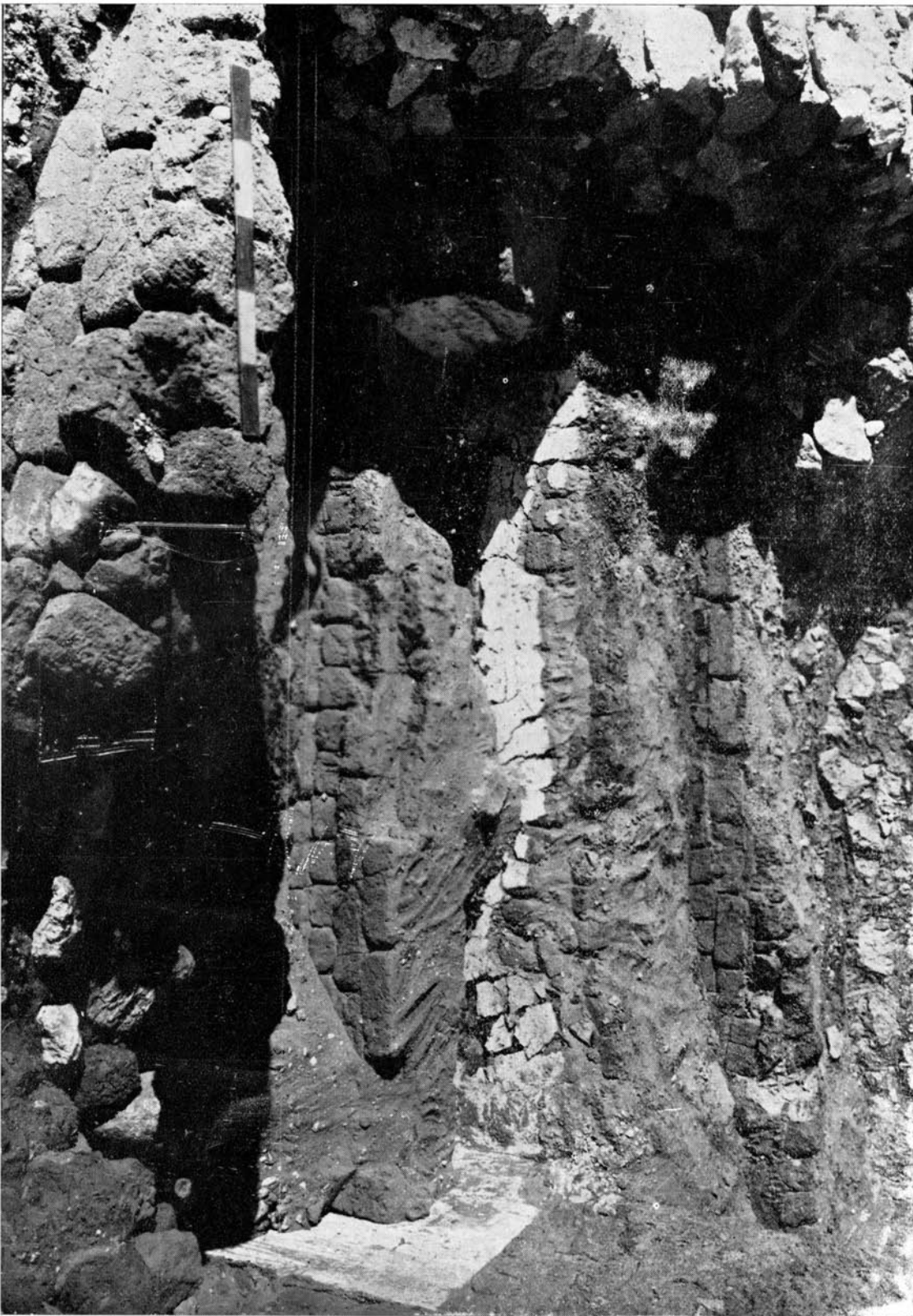
THE MASTABA OF NFR-THÛ

PL. XXII

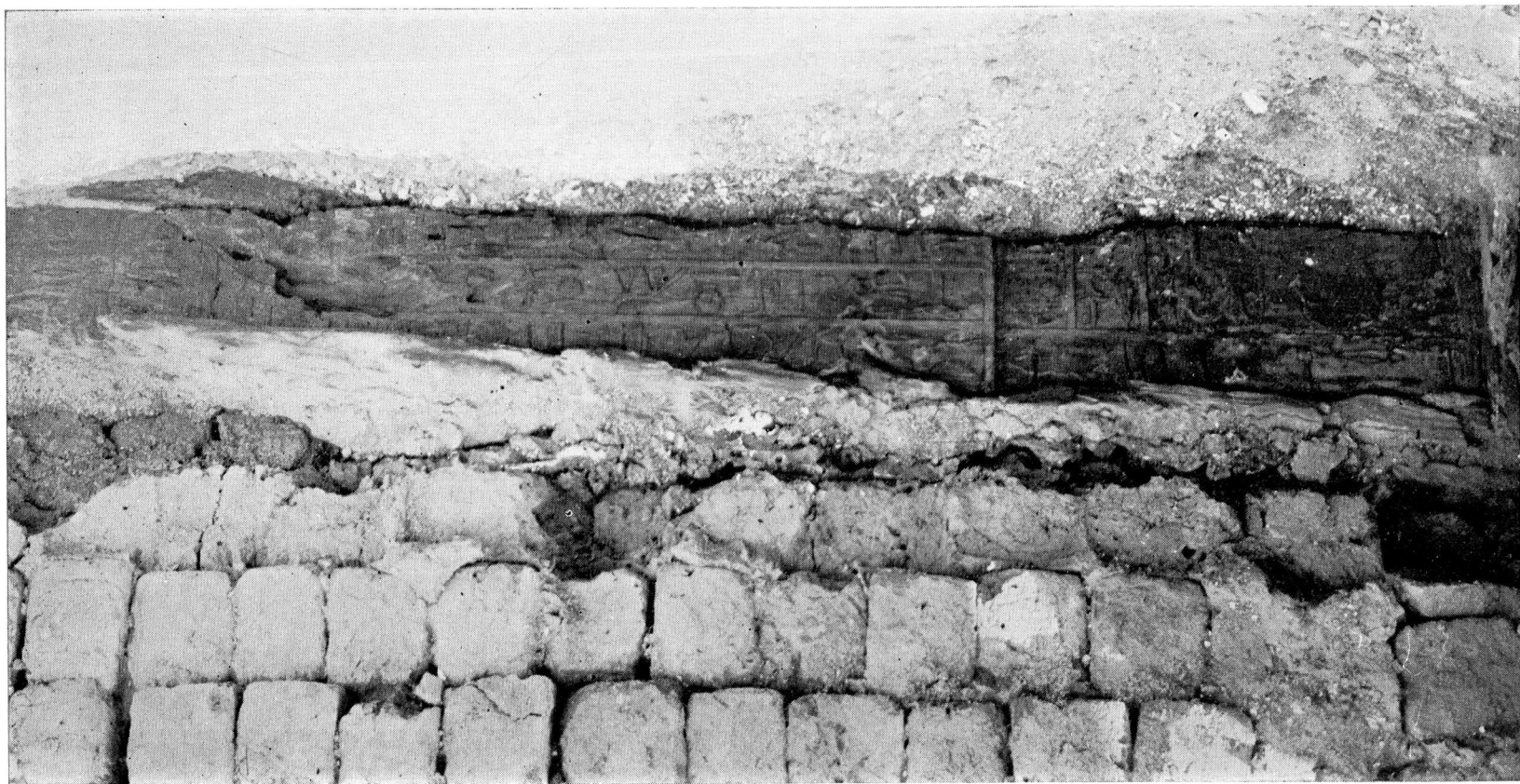
Second statue of Nfr-thû



General view—east side



The wall in which was placed the wooden false-door



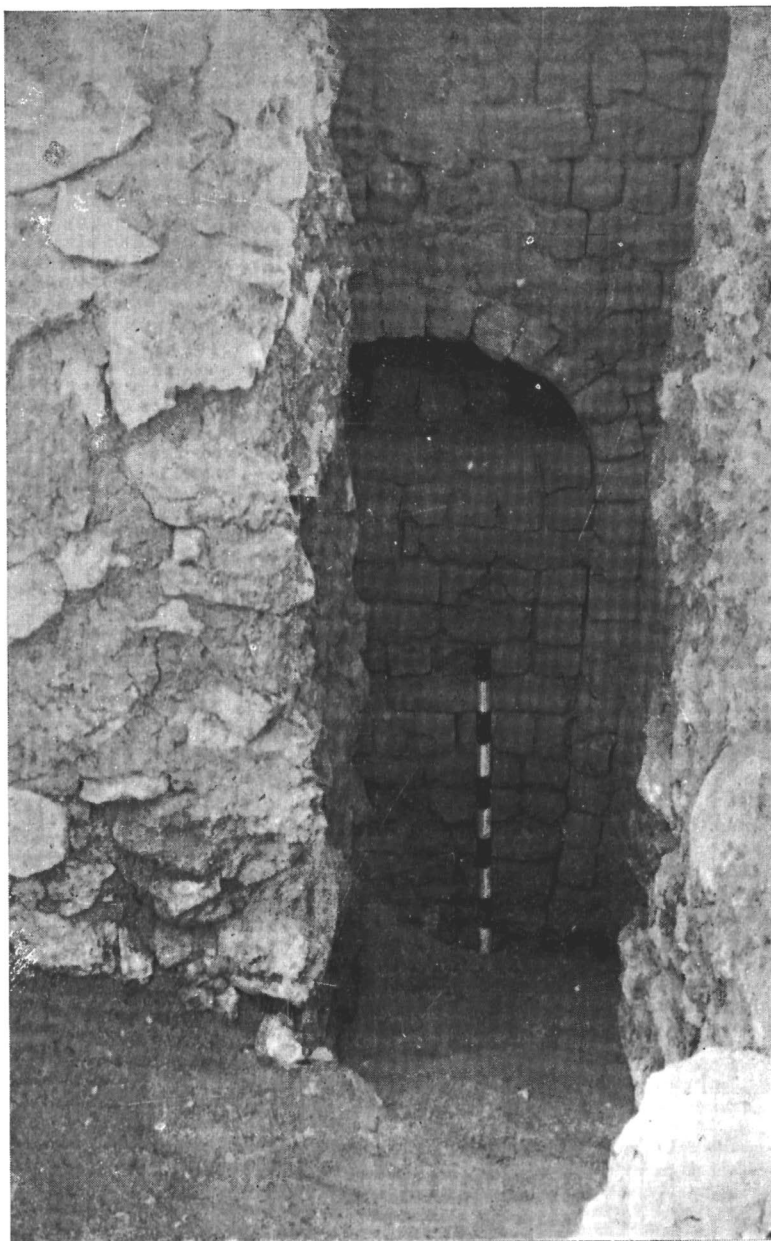
The upper lintel of the wooden false-door in situ



A part of the wooden false-door in situ

VAULTED DOOR ON TOP OF THE MASTABA

A



Blocked

B



After removing the filling

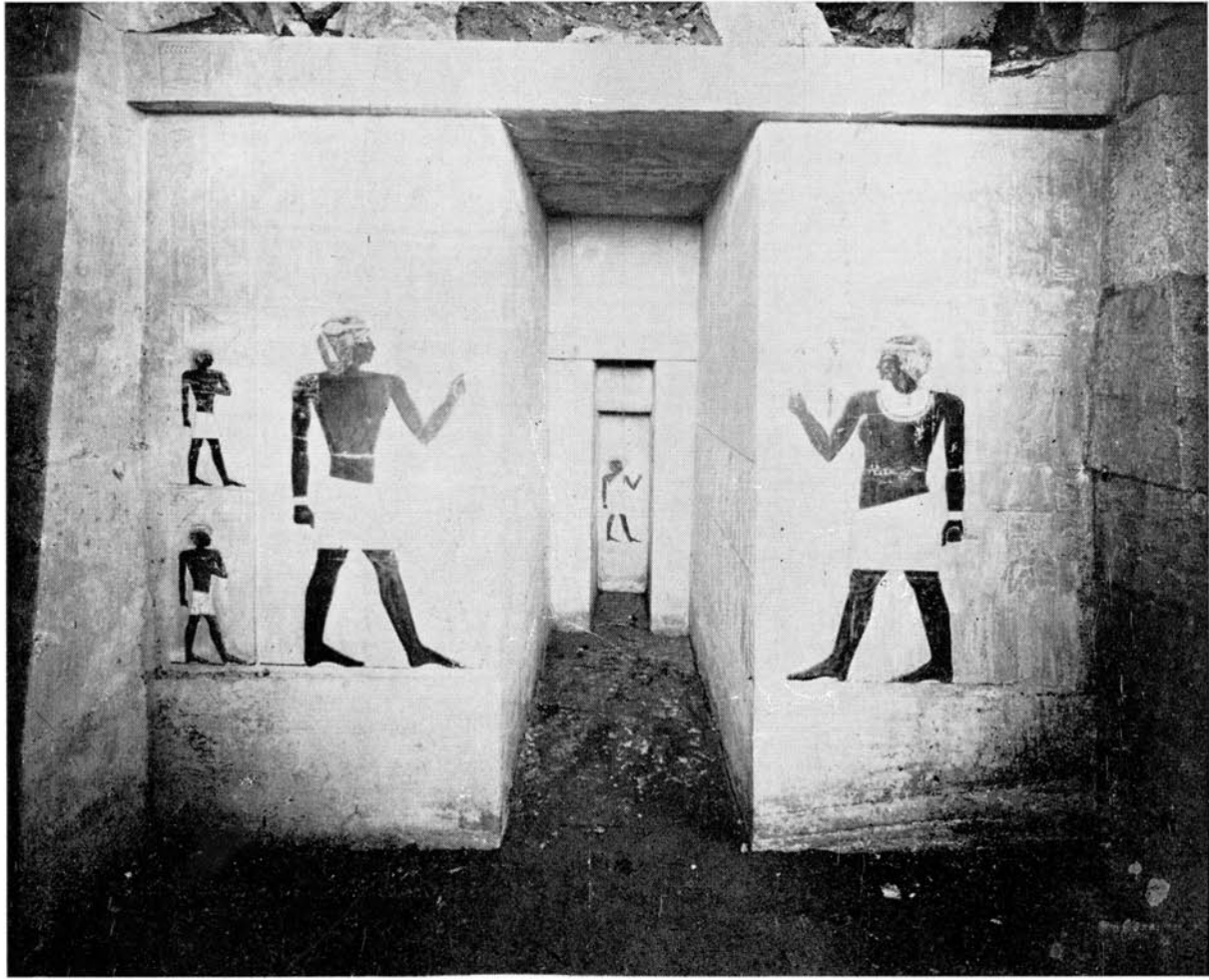


Entrance to the supposed serdab



North part of the vaulted room to the east of the mastaba

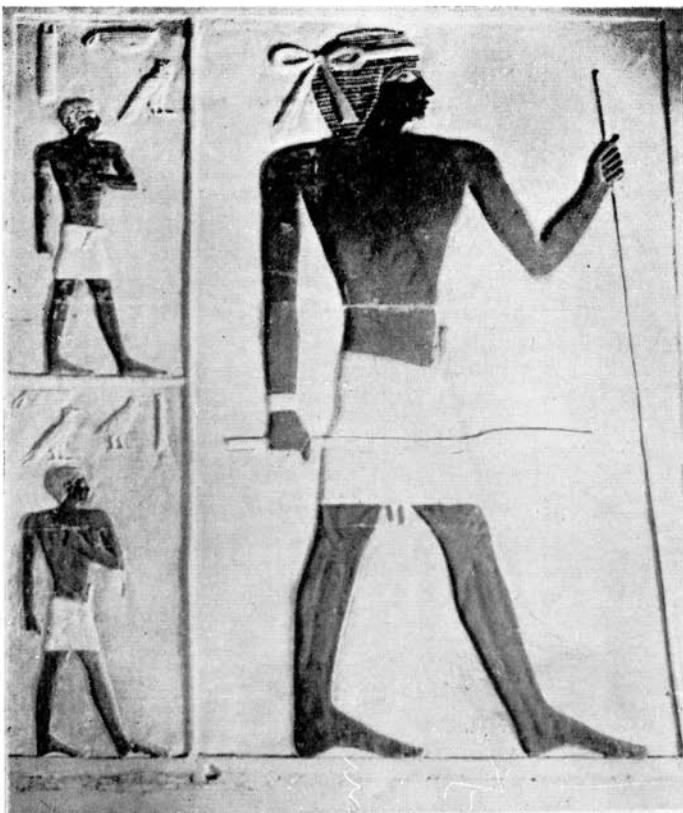
A



General view of the false-door

B

C



Façade of the left jamb—lower part

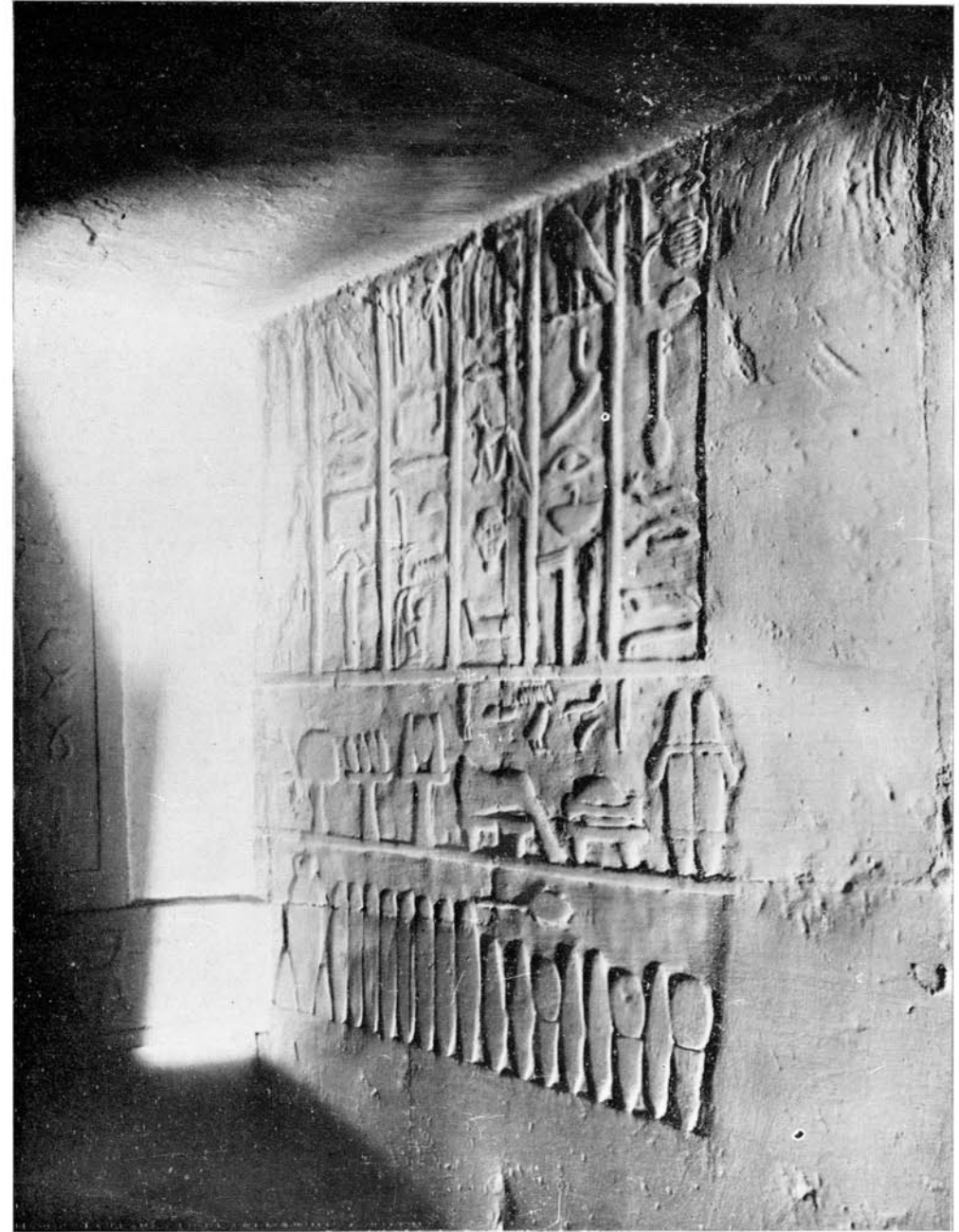


Façade of the right jamb—lower part

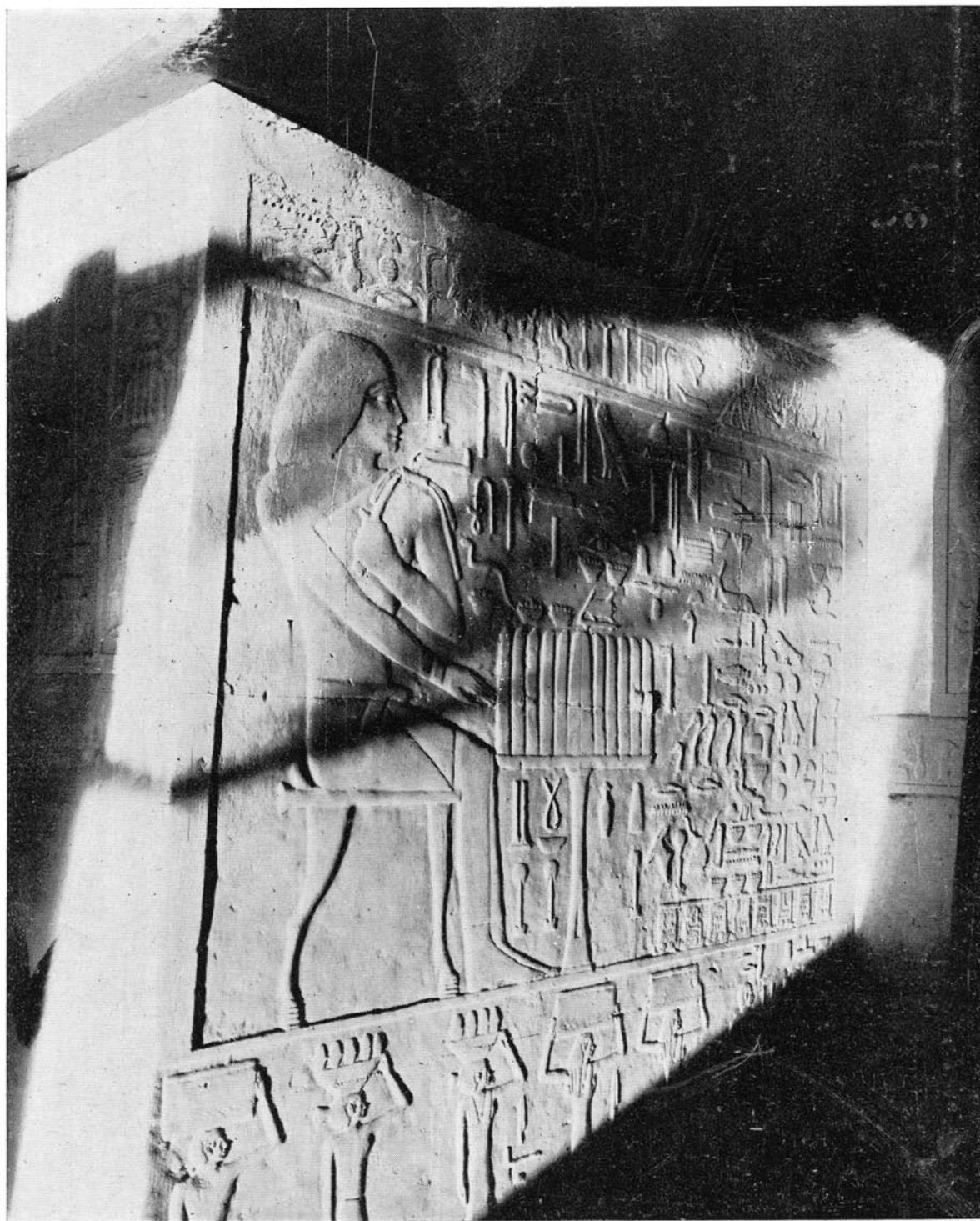
A



Left wall of the outer recess in the false-door—lower part

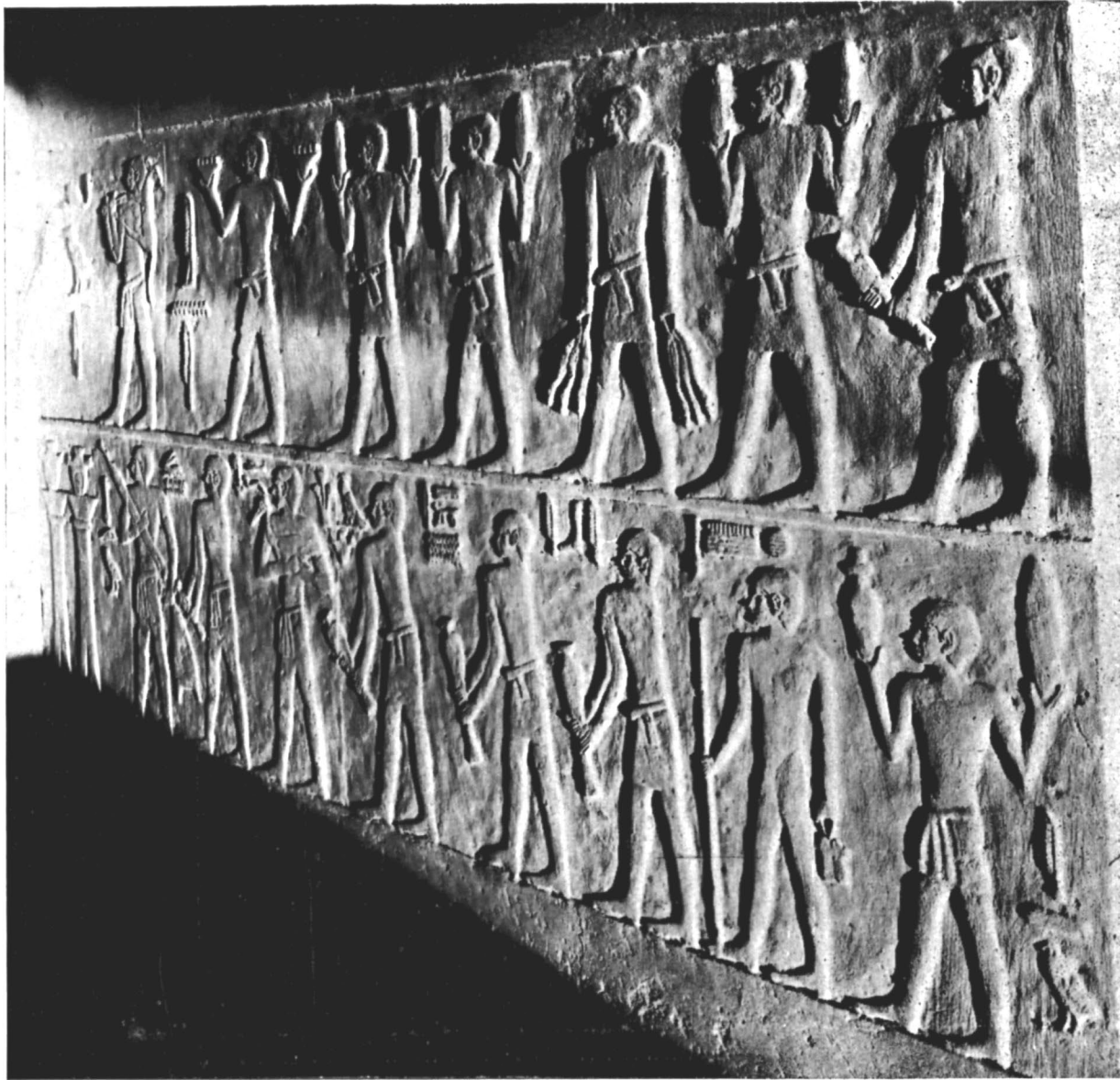


Right wall of the outer recess in the false-door—upper part



Left wall of the outer recess in the false-door—upper part

A

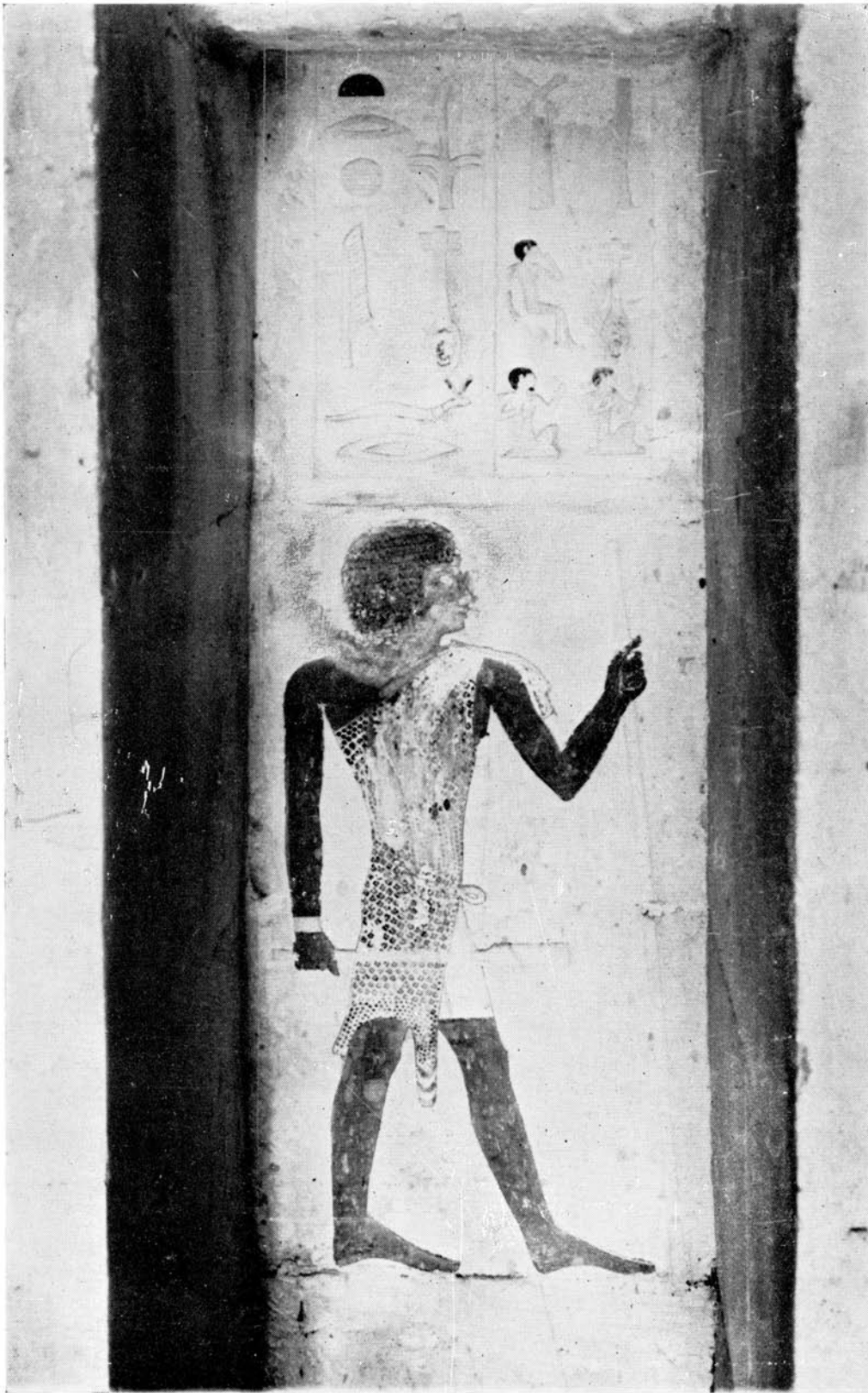


Right wall of the outer recess in the false-door—lower part

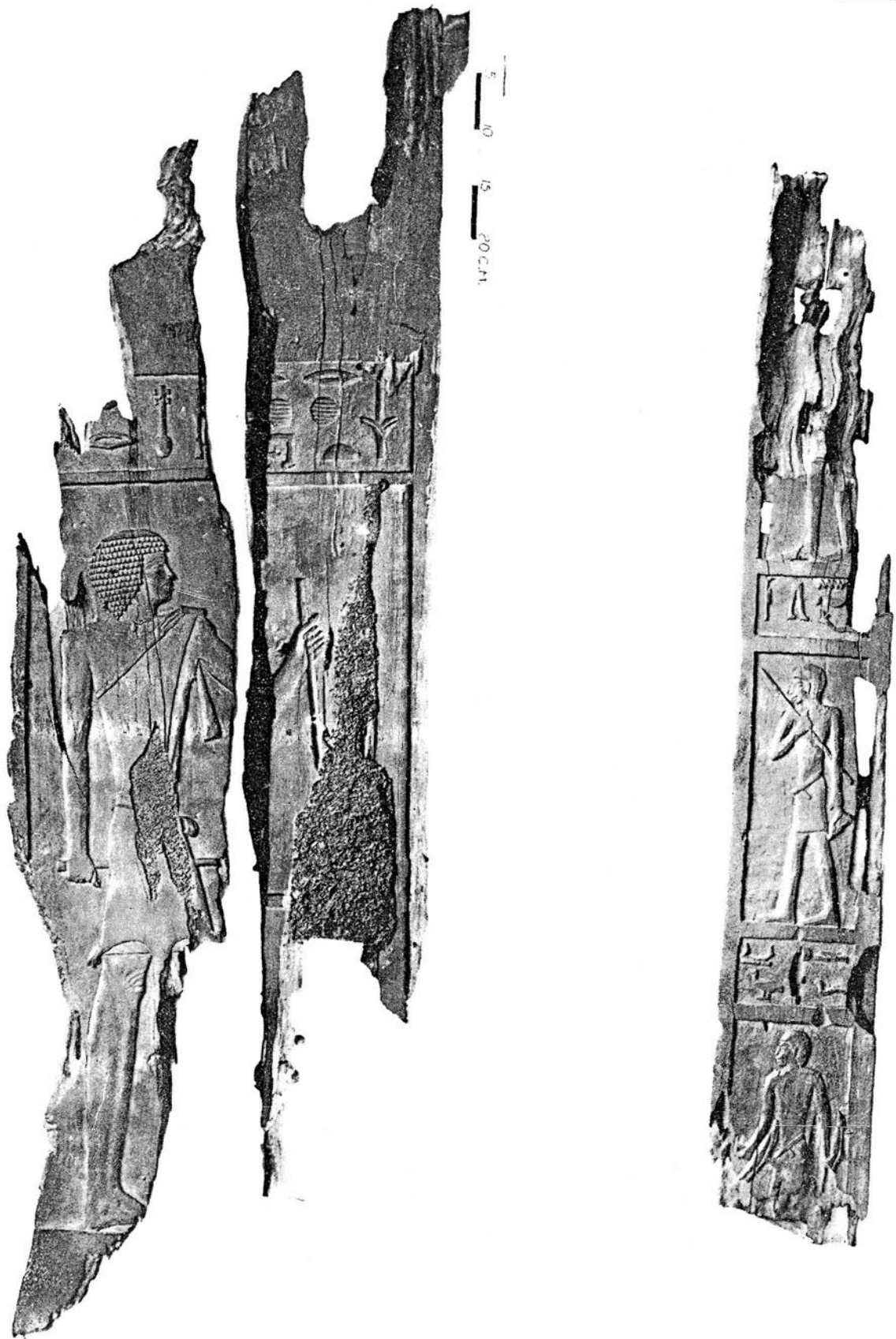
B



Part of the tablet



Inner panel of the recess



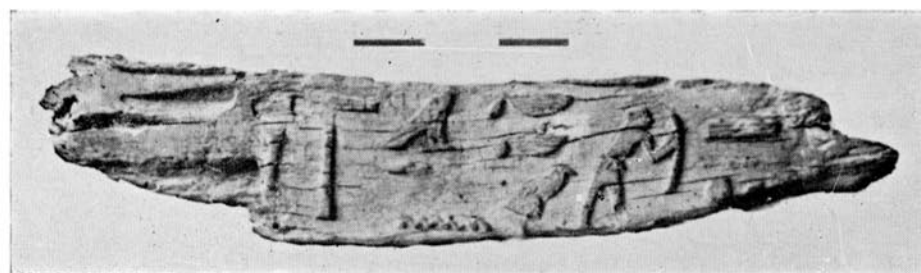
Fragments of the wooden false-door

A

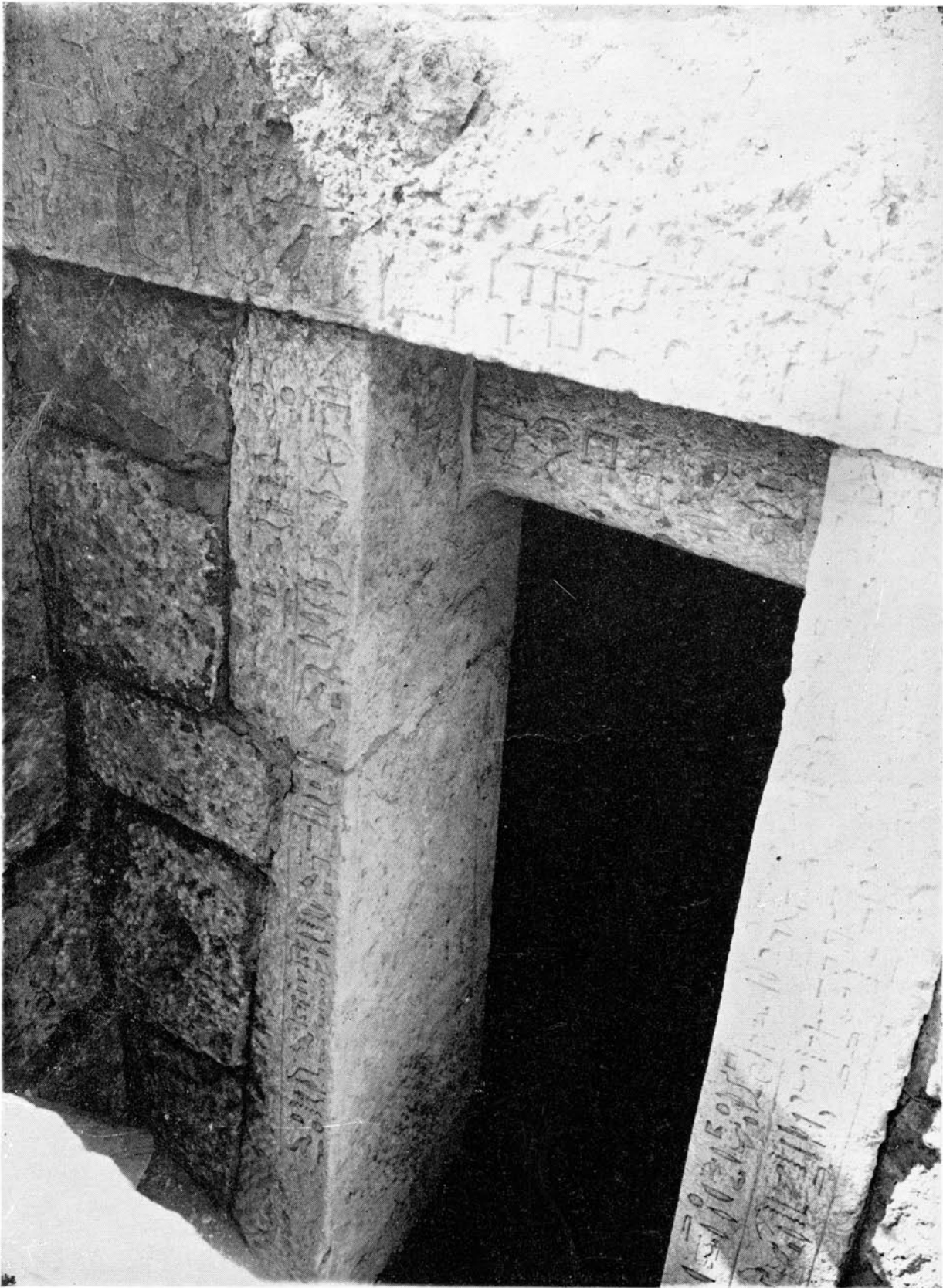


Upper lintel of the wooden false-door

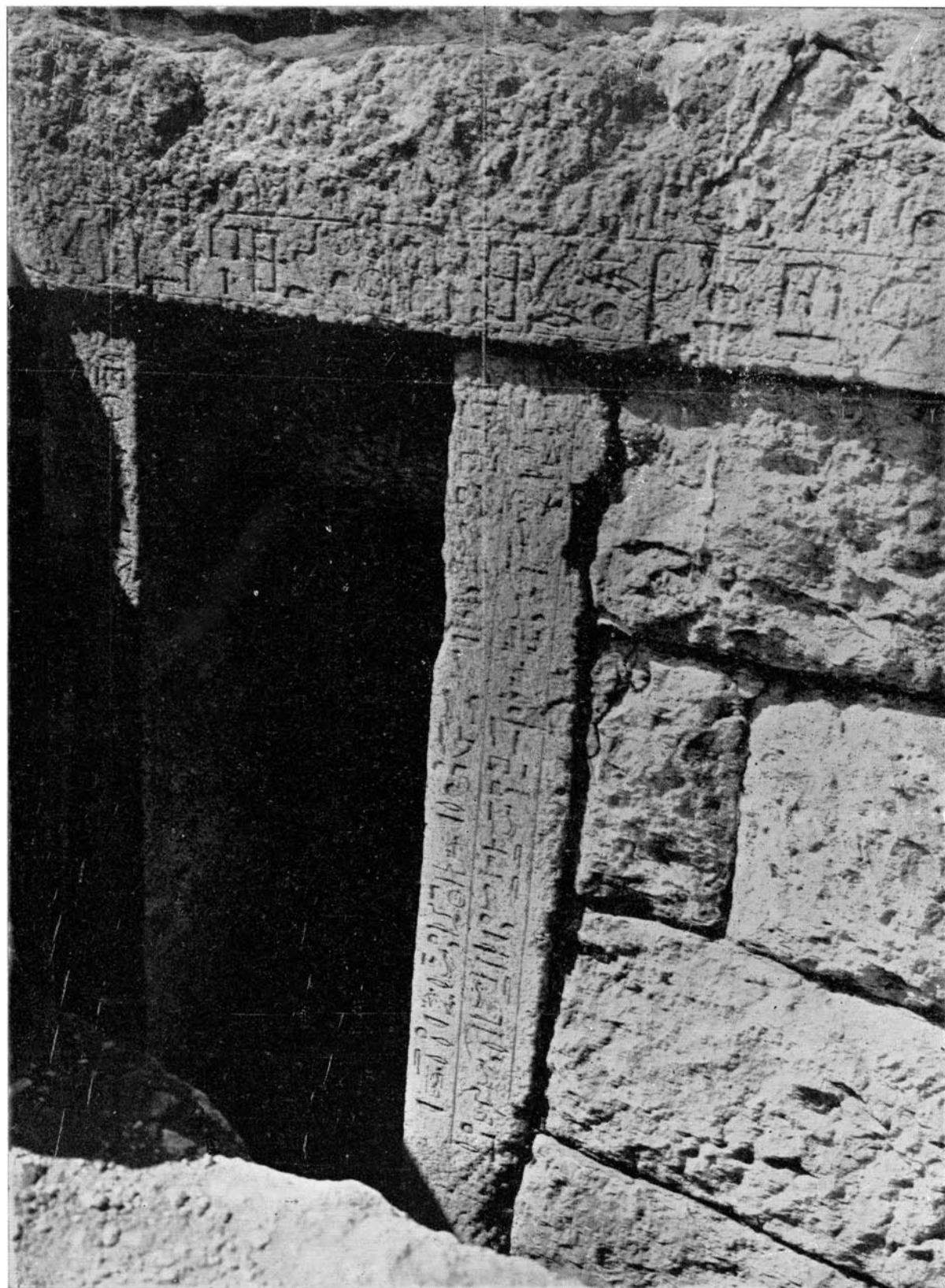
B



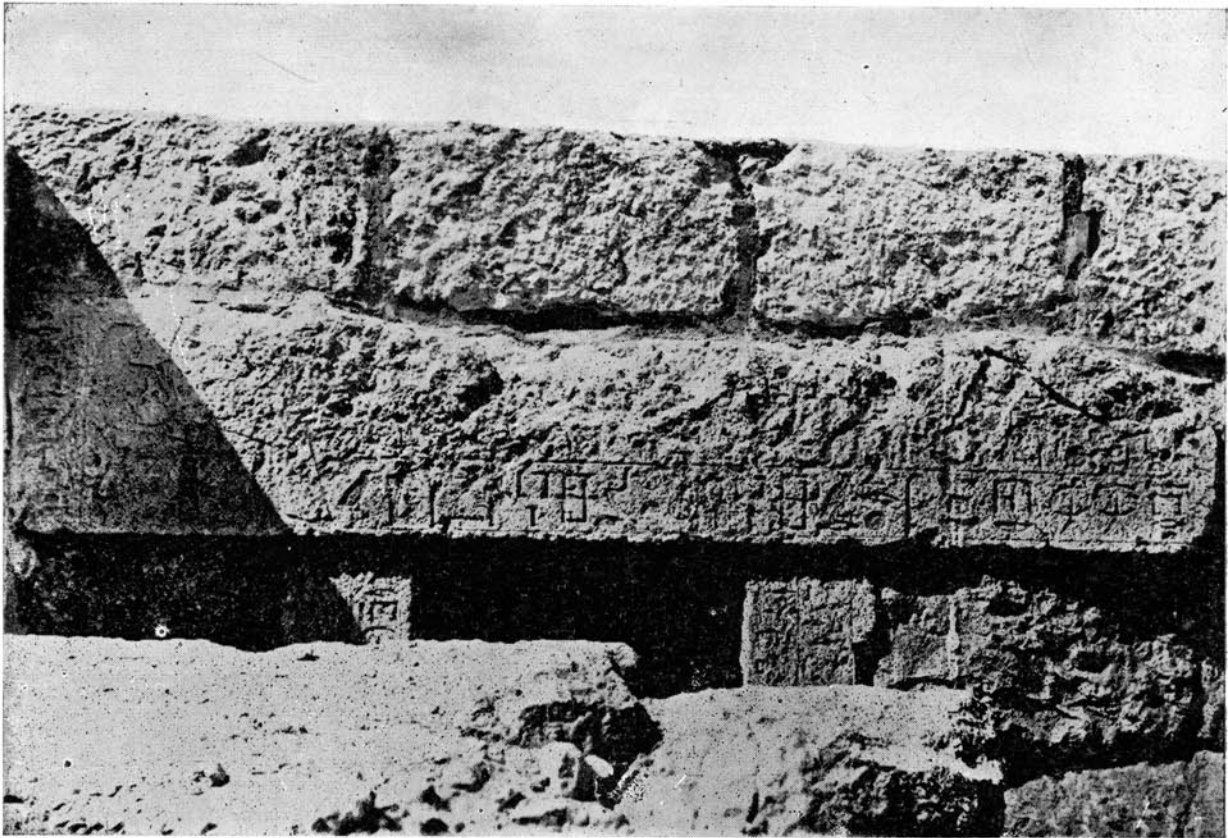
Part of the wooden false-door



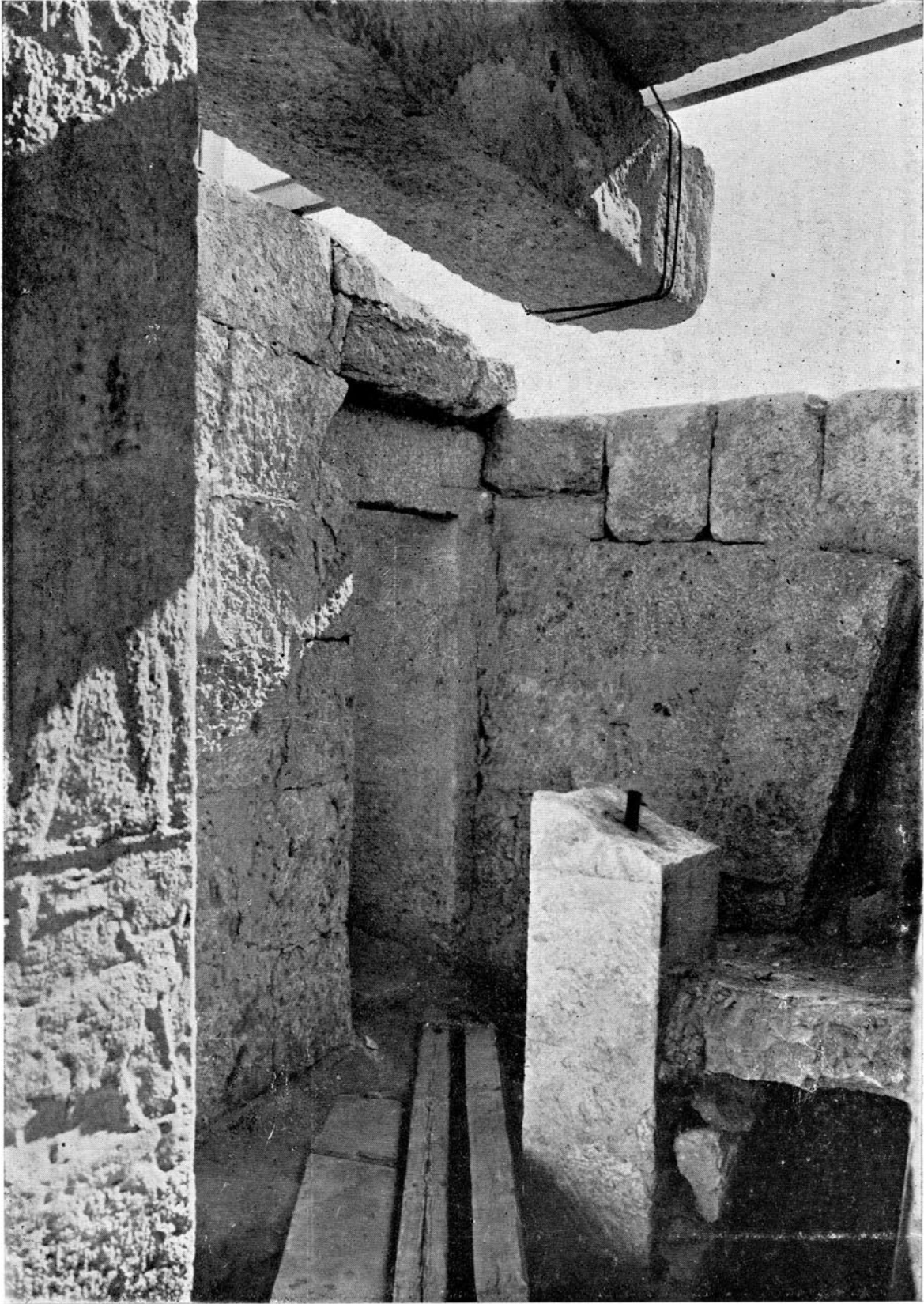
Entrance of the chapel



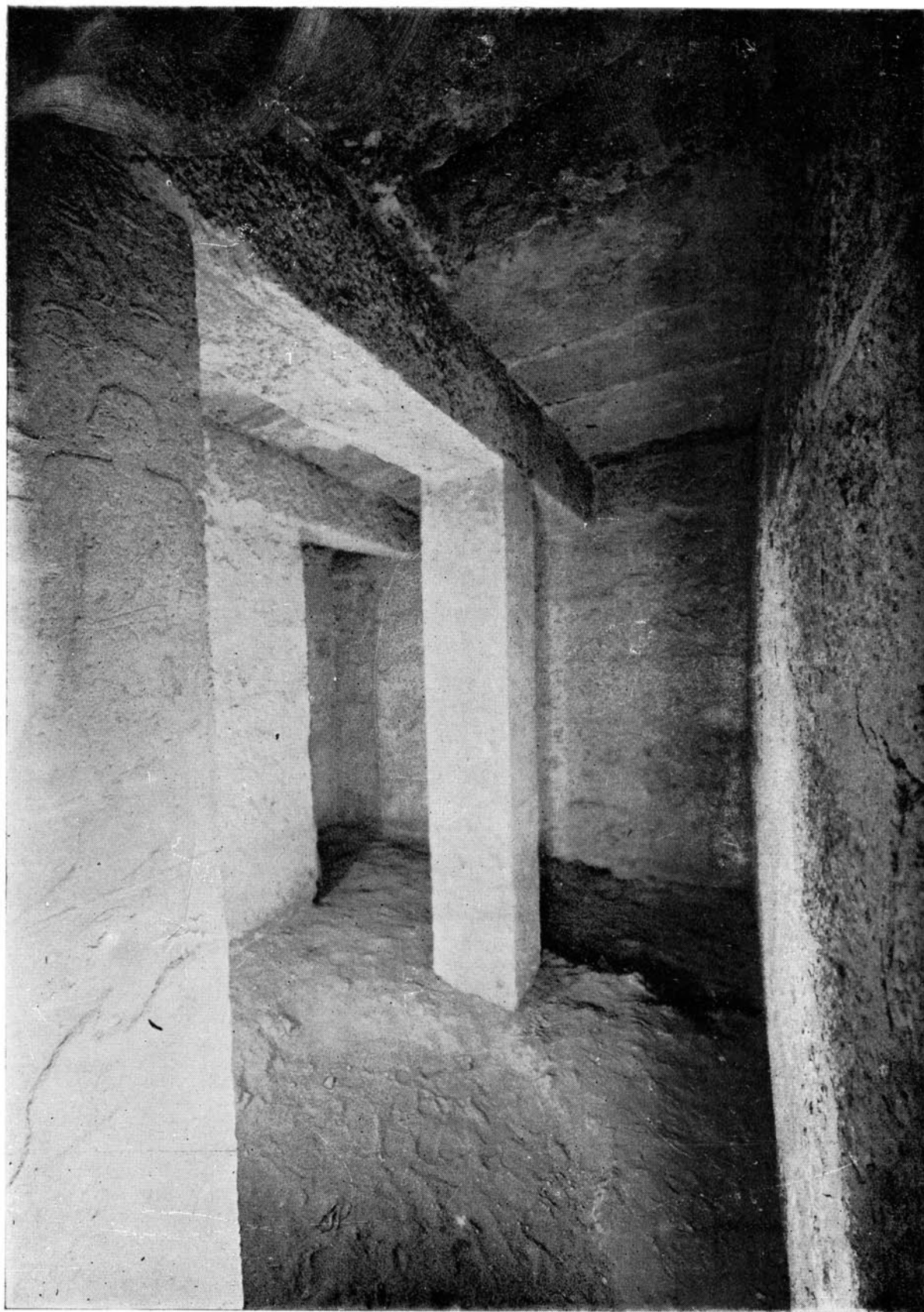
Lintel and right jamb of the entrance



Lintel over the entrance door



The chapel before reconstruction



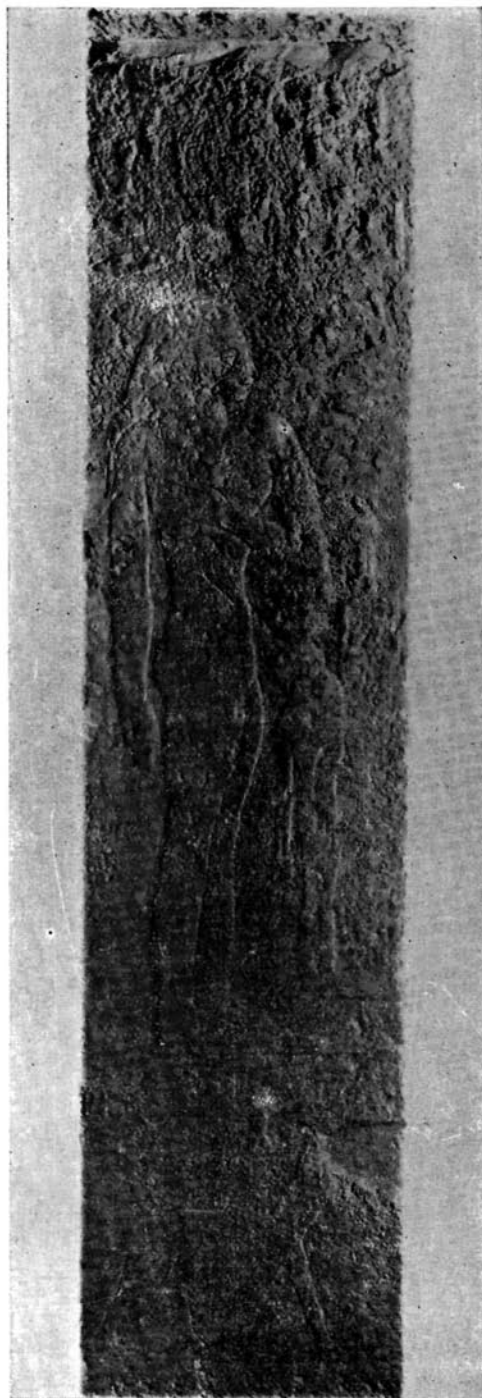
The chapel after reconstruction

A



Northern pillar-west face

B



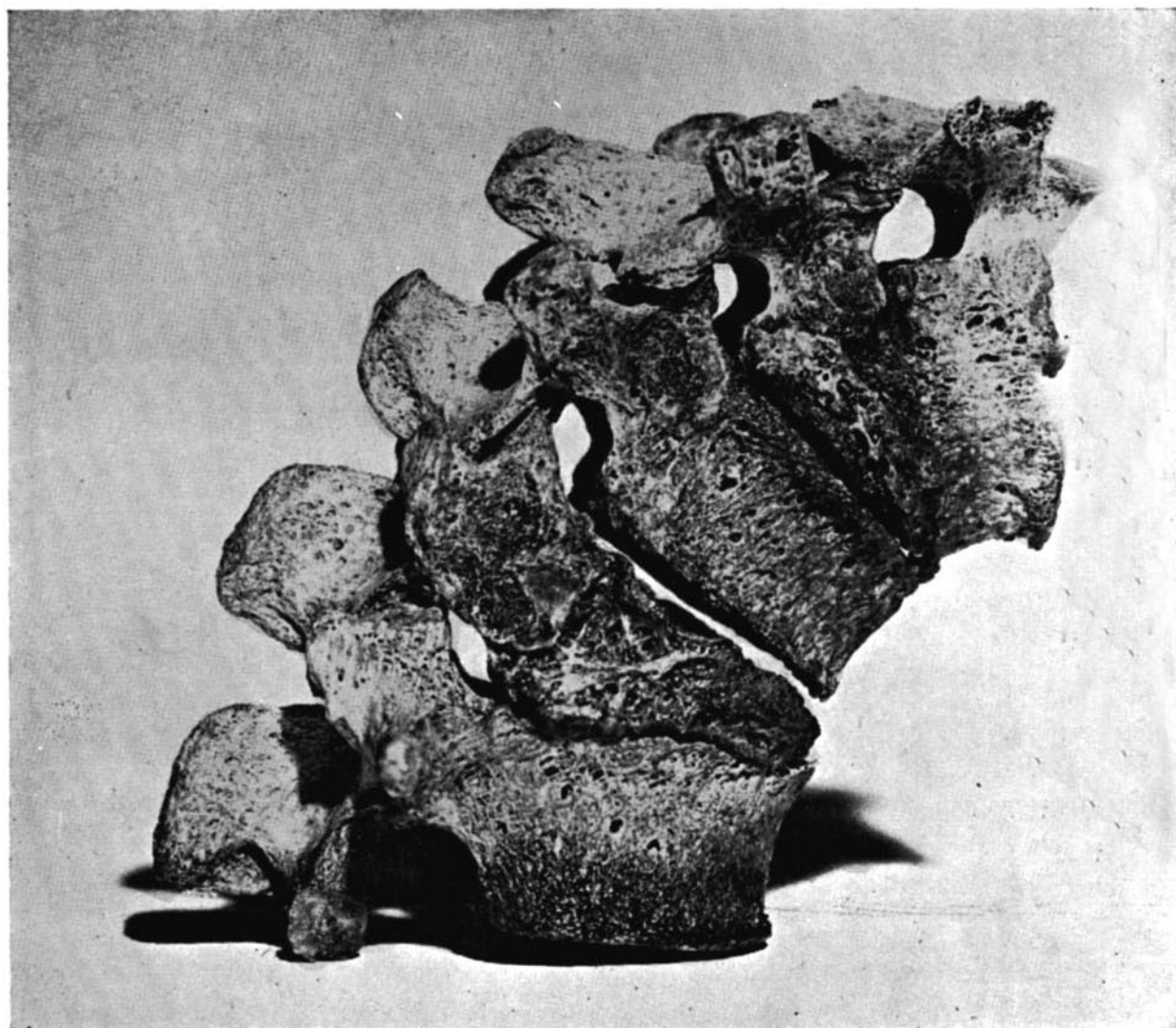
Southern pillar-north face

A

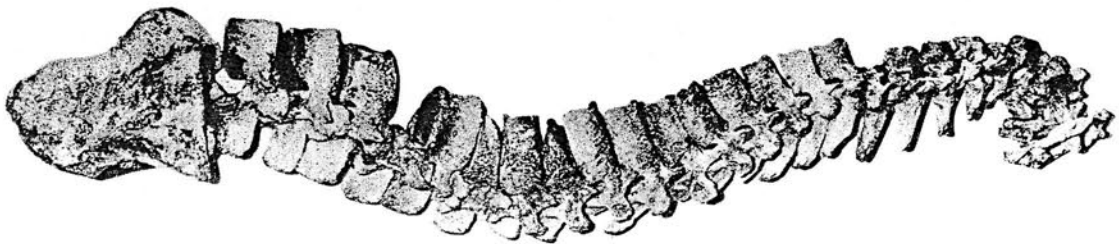
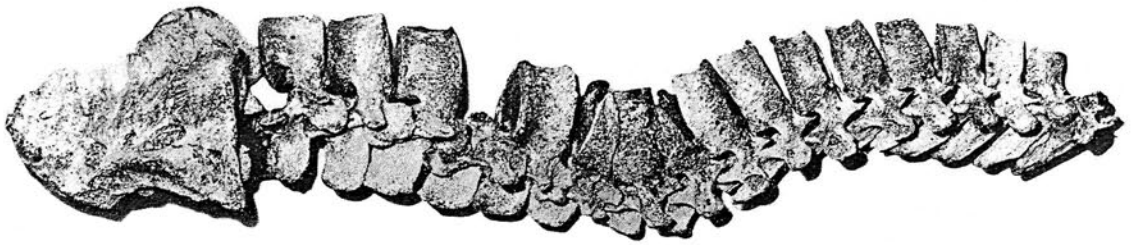


Skeleton showing kyphosis (hunch-back) of the spine

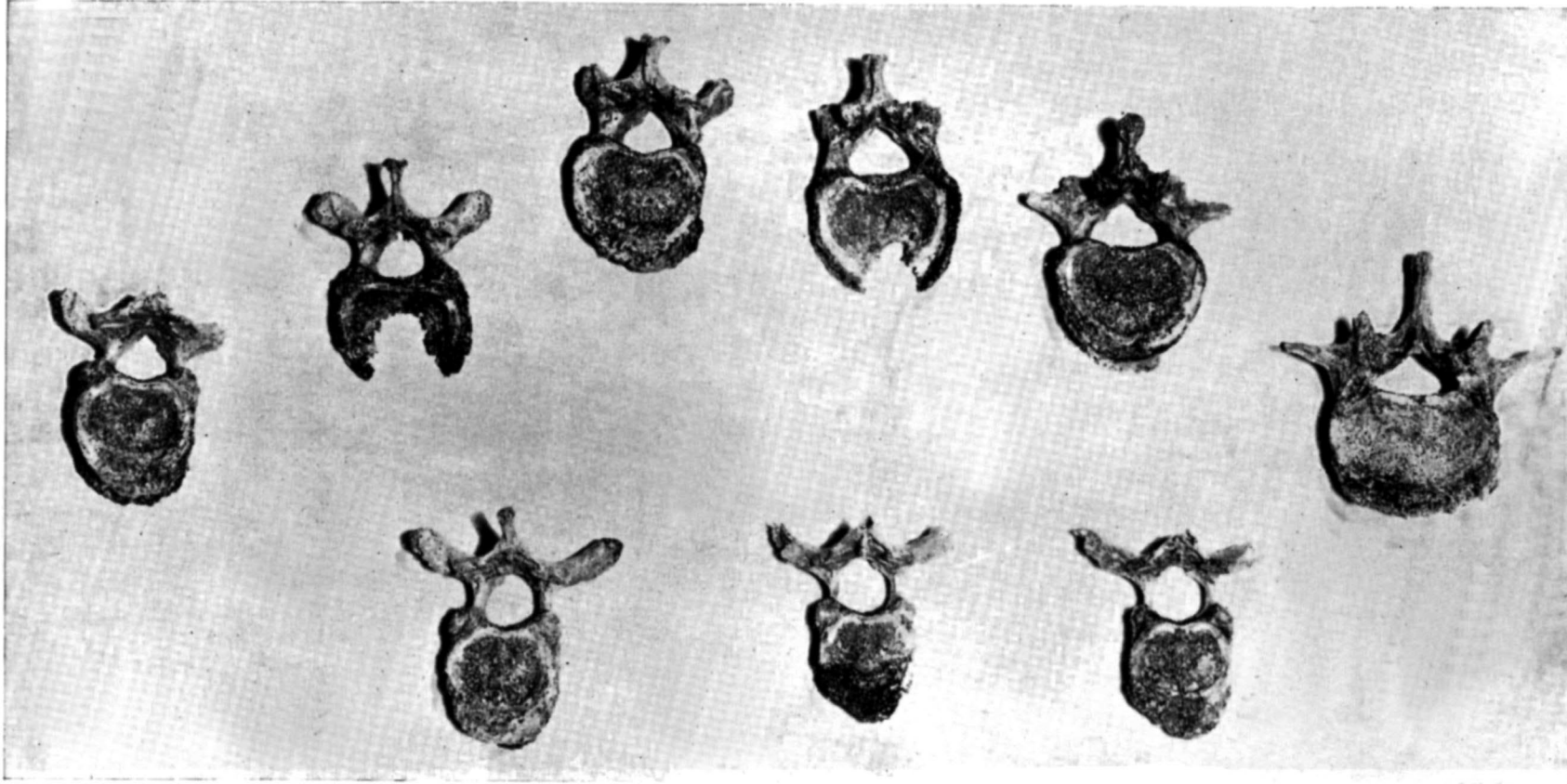
B



Part of vertebral column showing collapse of 10 and 12 vertebrae



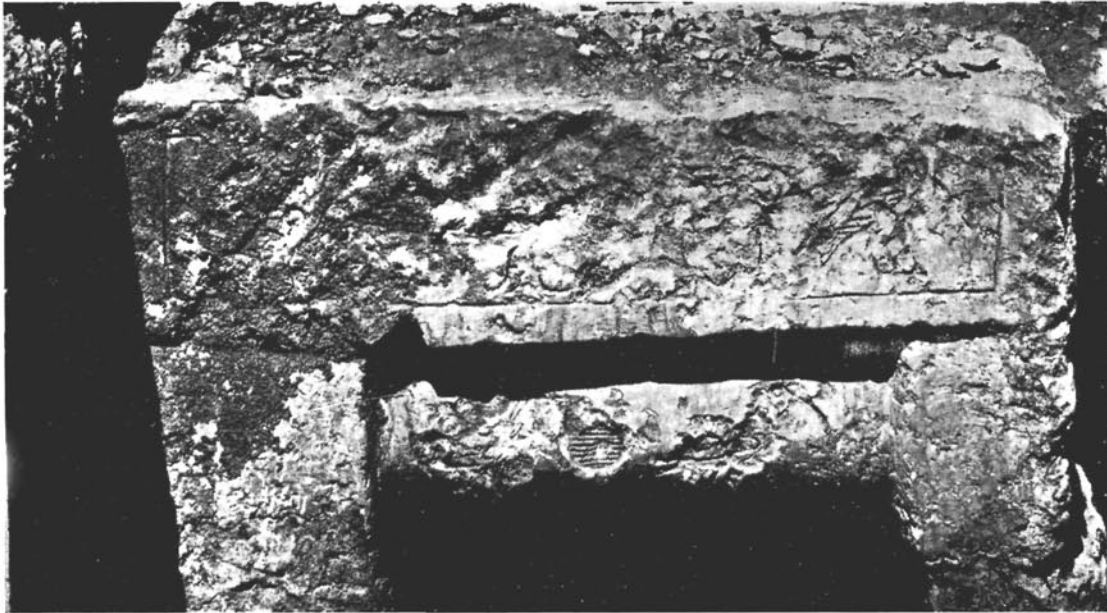
Photographs of vertebral bodies, some showing compression and some osteophytic changes



The vertebral column showing collapse of 10 and 12 vertebrae



East side of the mastaba



A

Upper part of the false-door



B

Upper part of the false door found near the mastaba

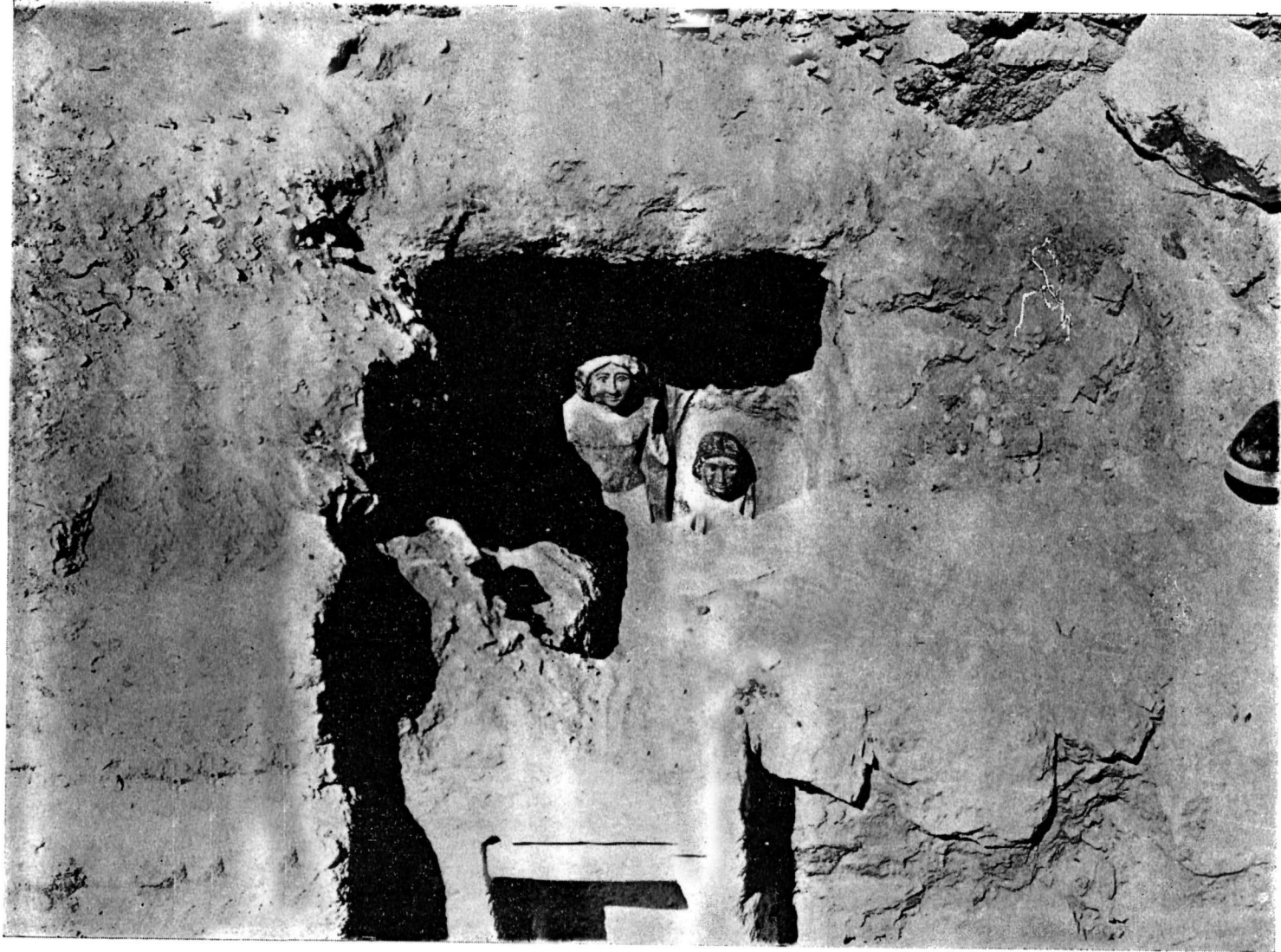


C

Lintel found near the mastaba



False-door and serdab



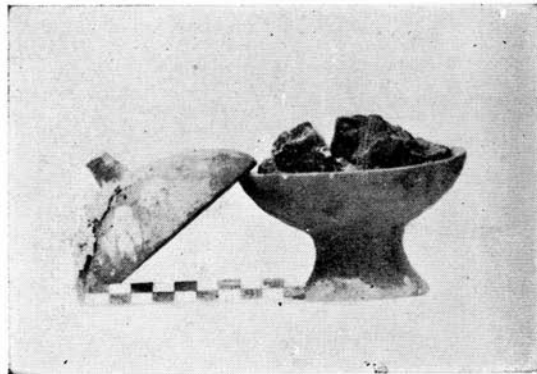
Statues in the serdab

A



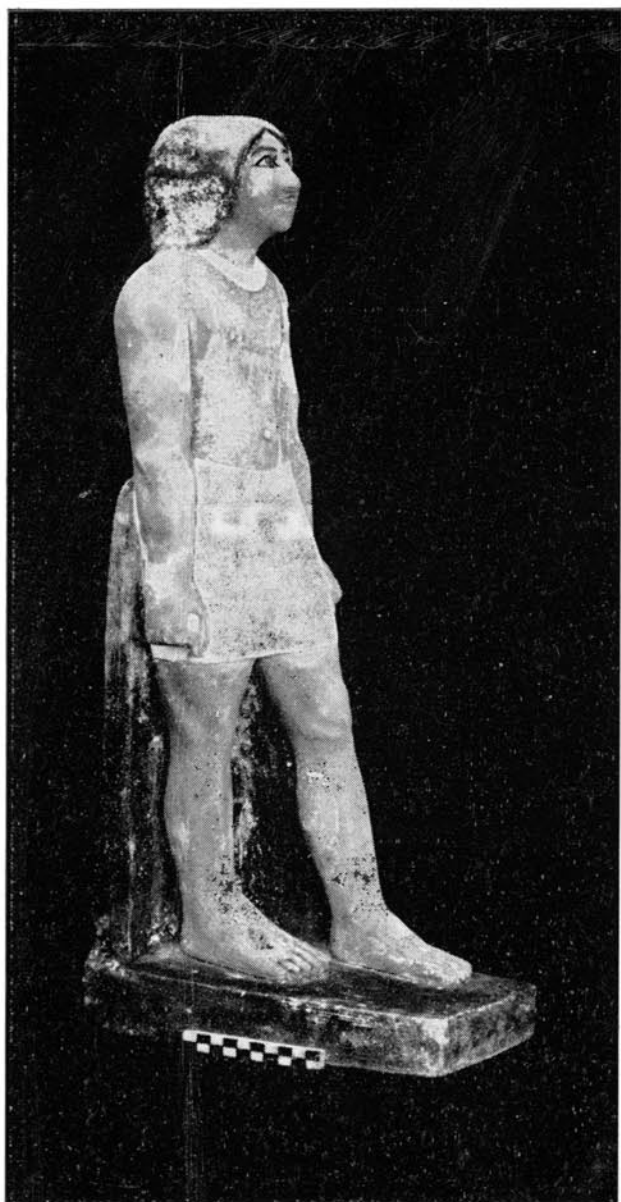
Statues in the serdab

B



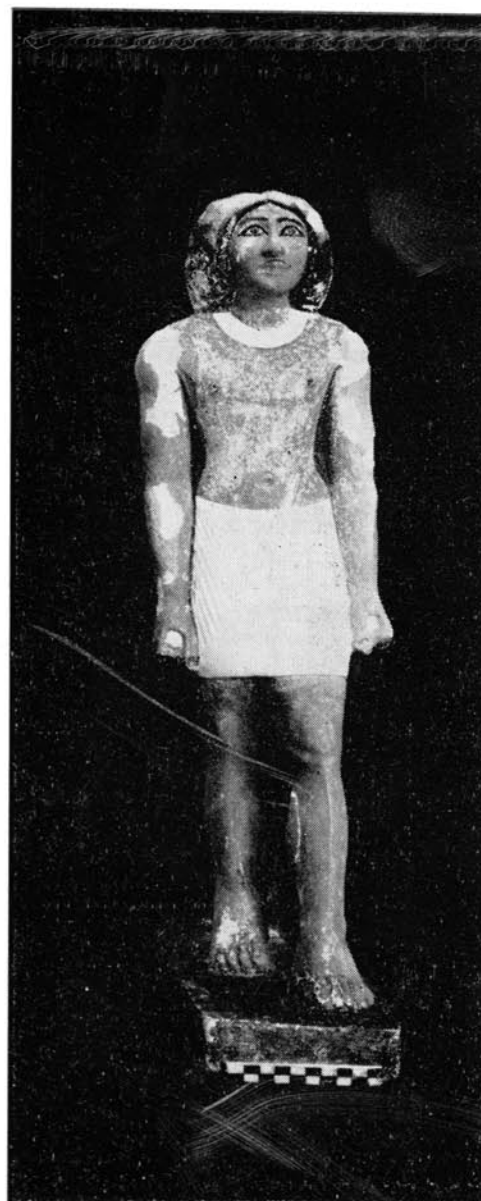
The incense pot found in the serdab

A



Statue of *ḥw*

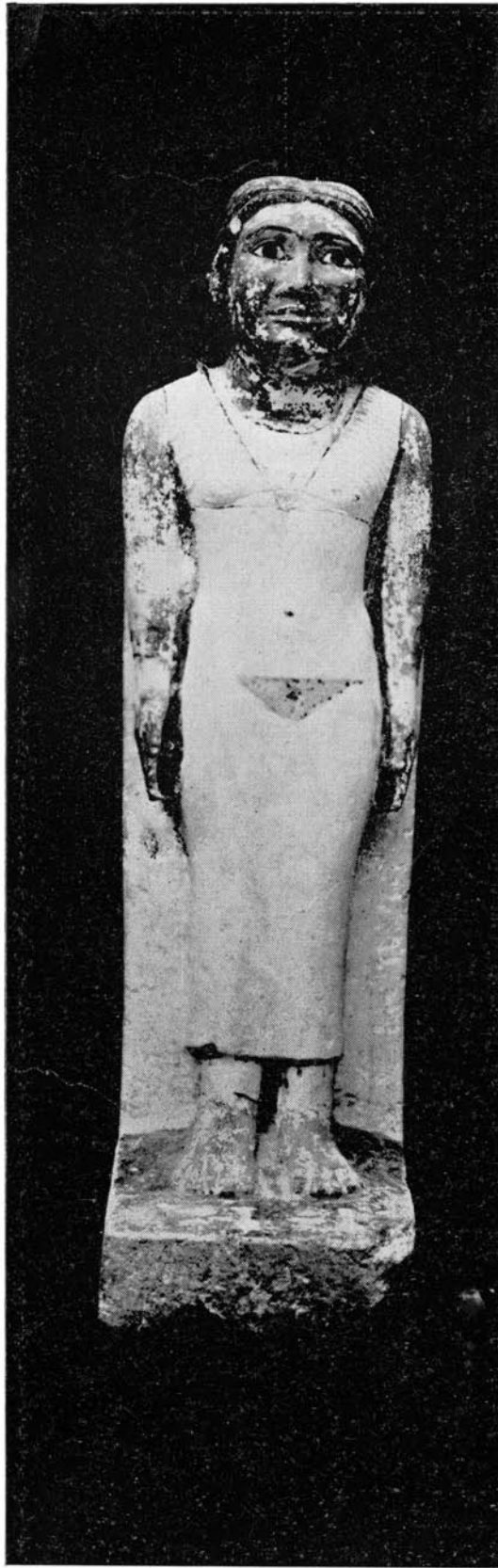
B



Statue of *ḥw*



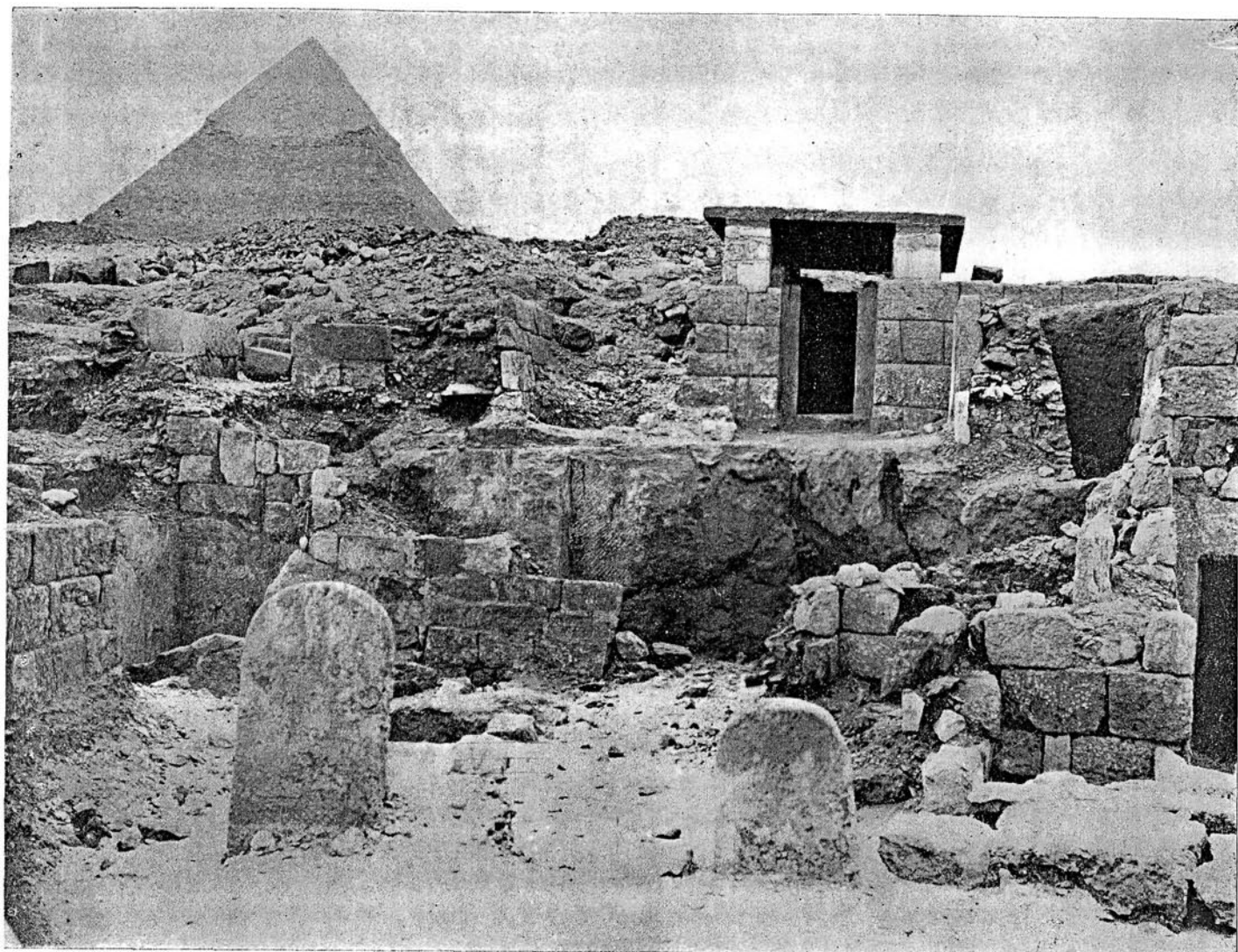
Statue of *Ihu*



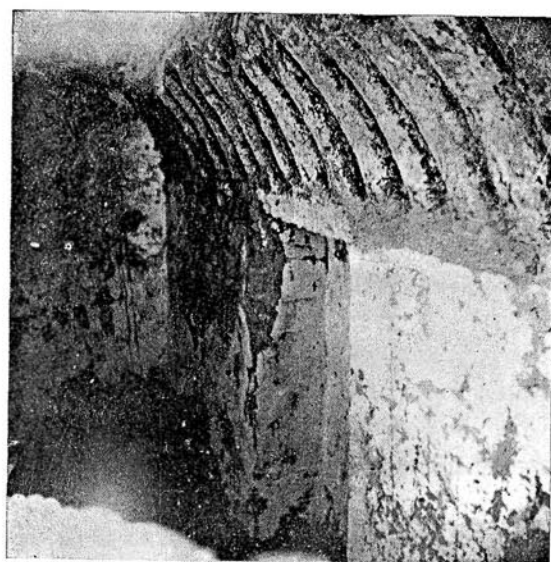
Statue of Nfert



Kiss scene of the eastern façade of Mastaba "C"

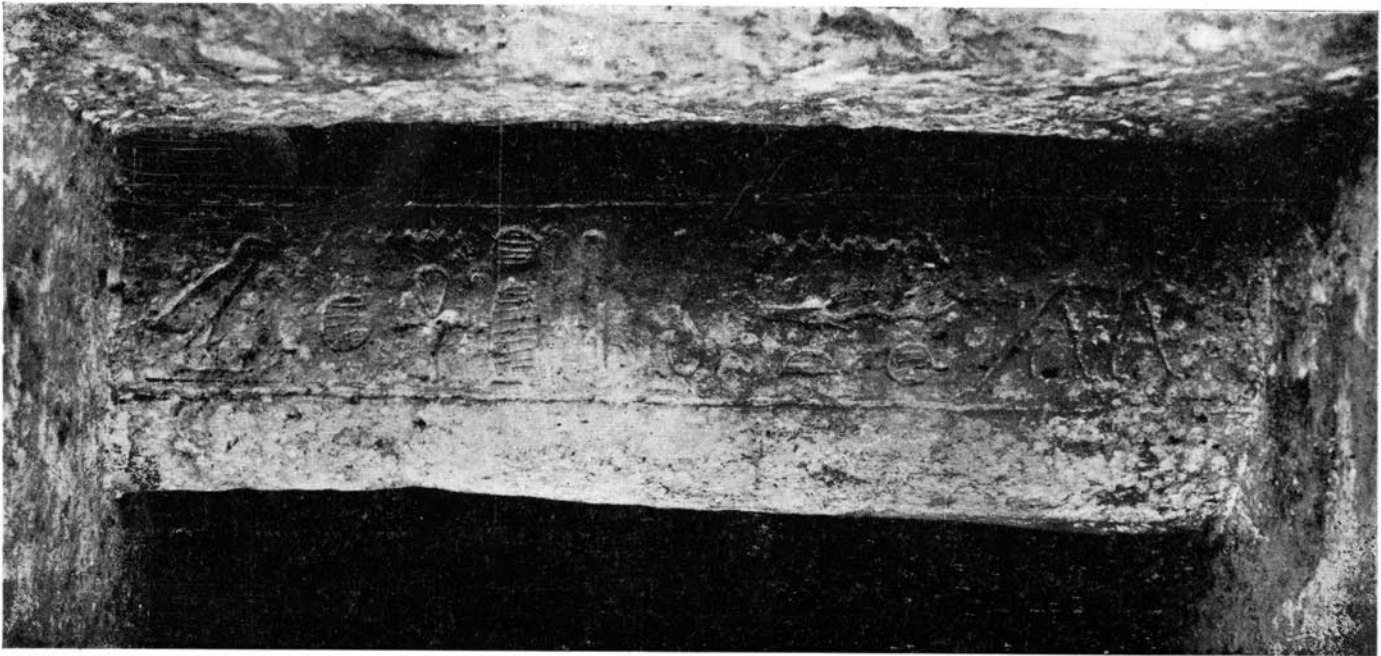


General view—north side of the mastaba



B

Part of the vaulted roof



Drum above the entrance

A



The bank-like superstructure of the shaft

B



The body found buried in the shaft

A

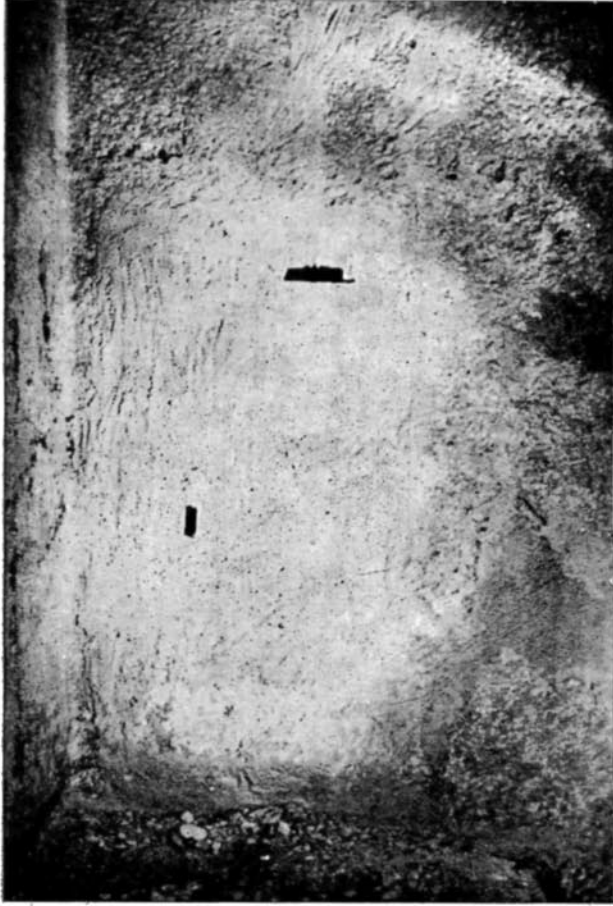


Stela above the entrance-door

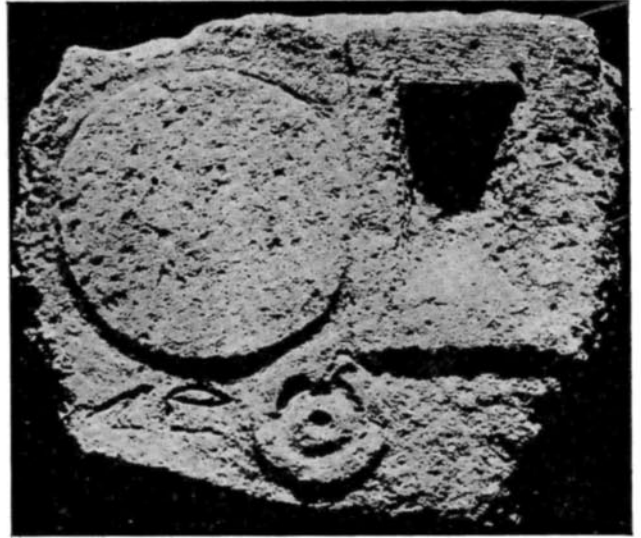
B



Scene on the east wall



A



B

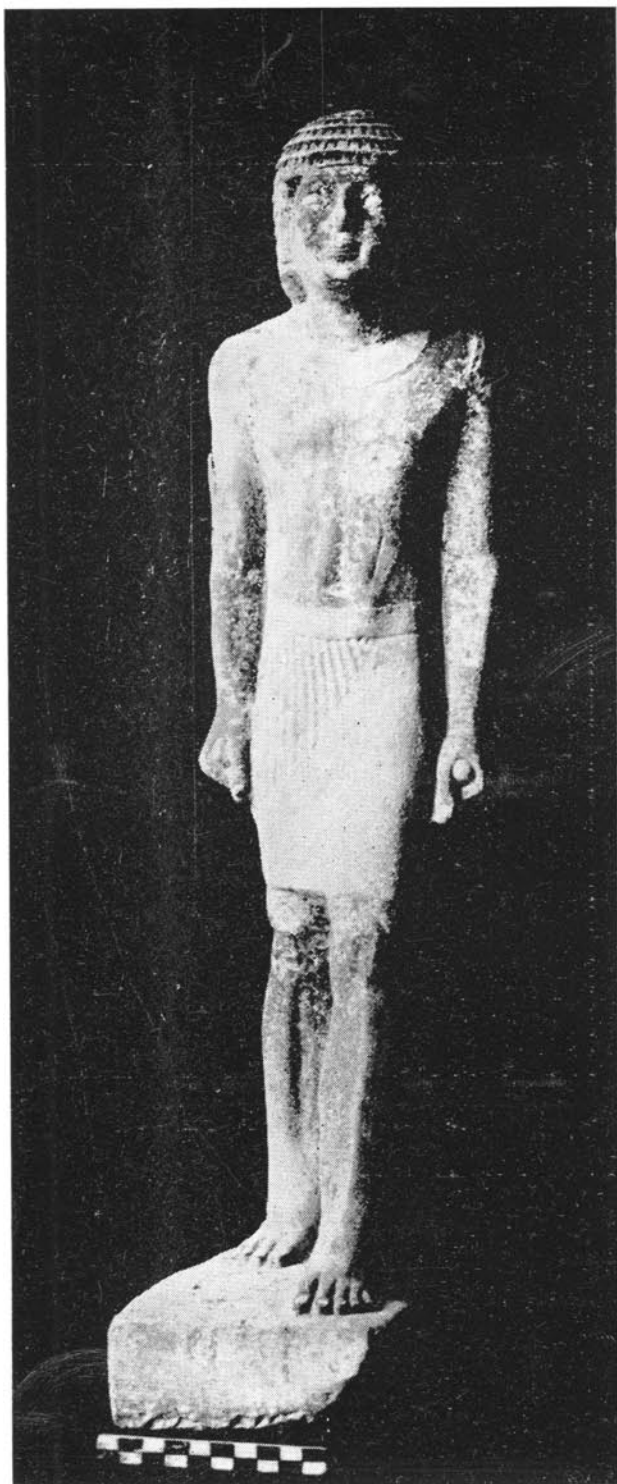
Serdab—blocked by limestone slabs

Offering-table of *Wr-R'*

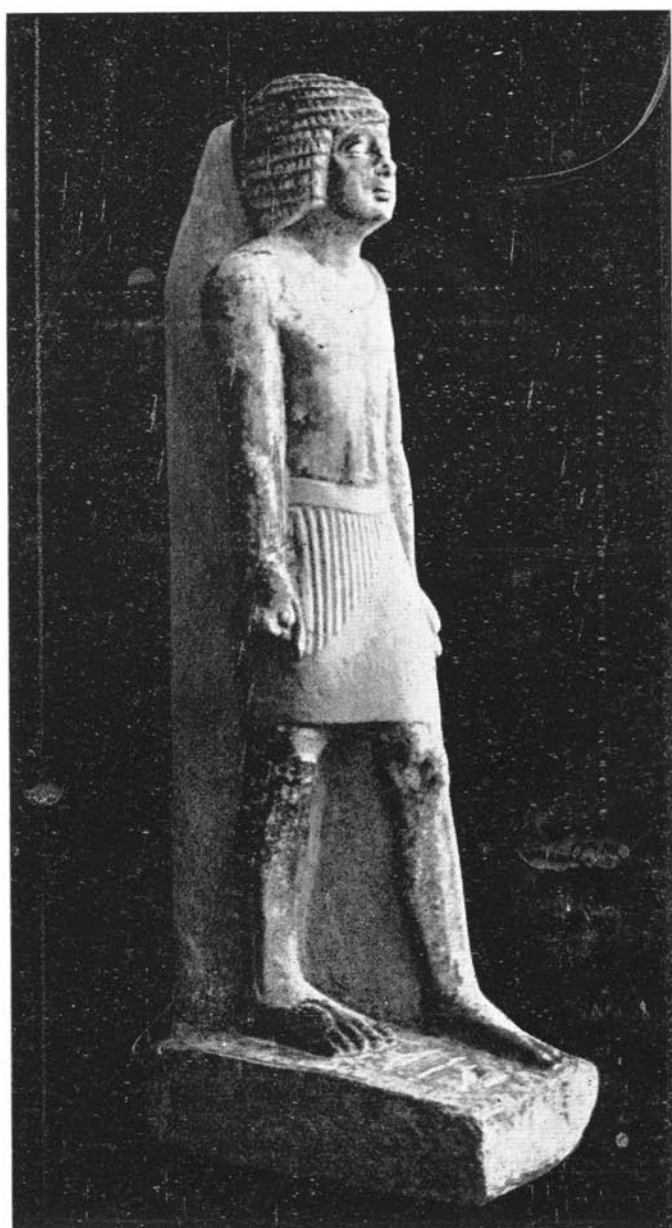


Statues in the serdab

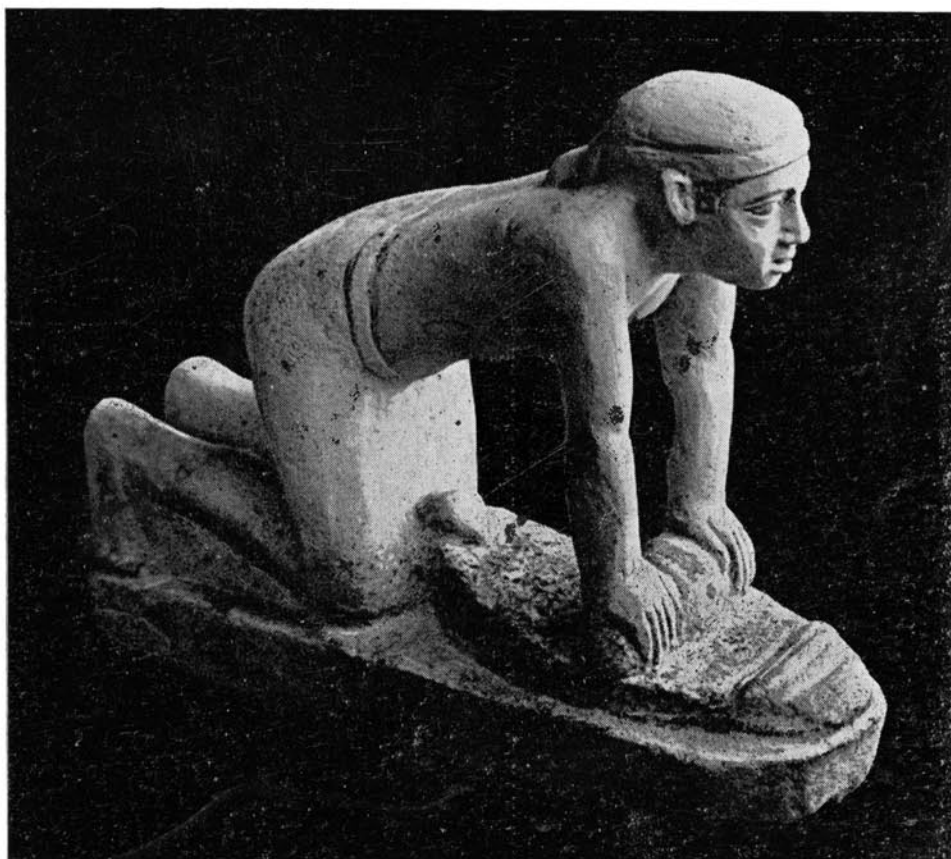
A



B



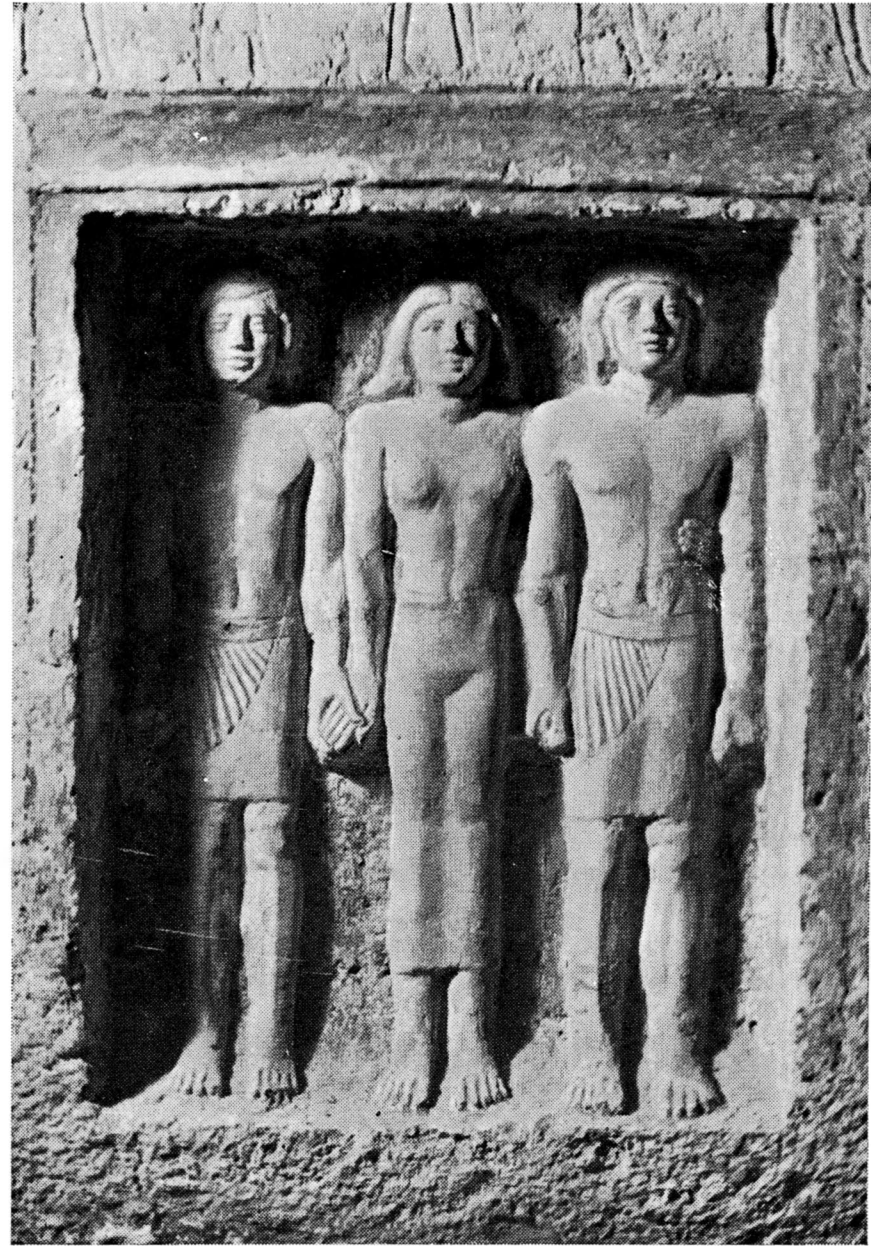
Statue of Wr-R'



Statue of a female grinding grain

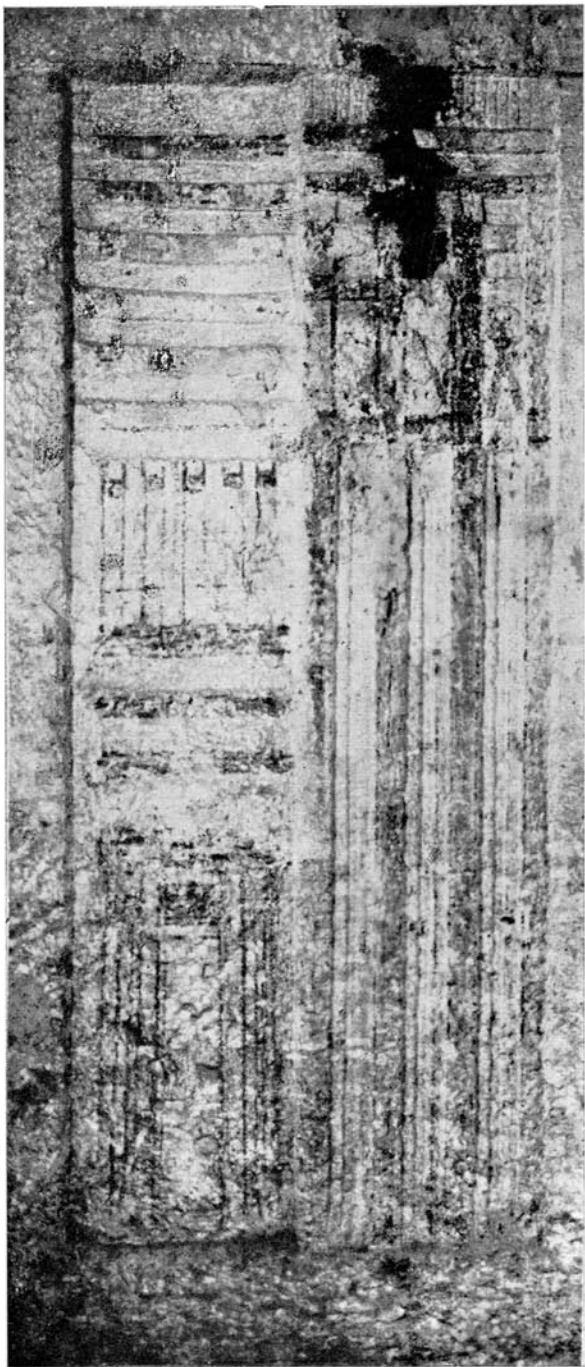


Two figures hewn in the north wall



Three figures hewn in the west wall

A



False-door—west wall

B

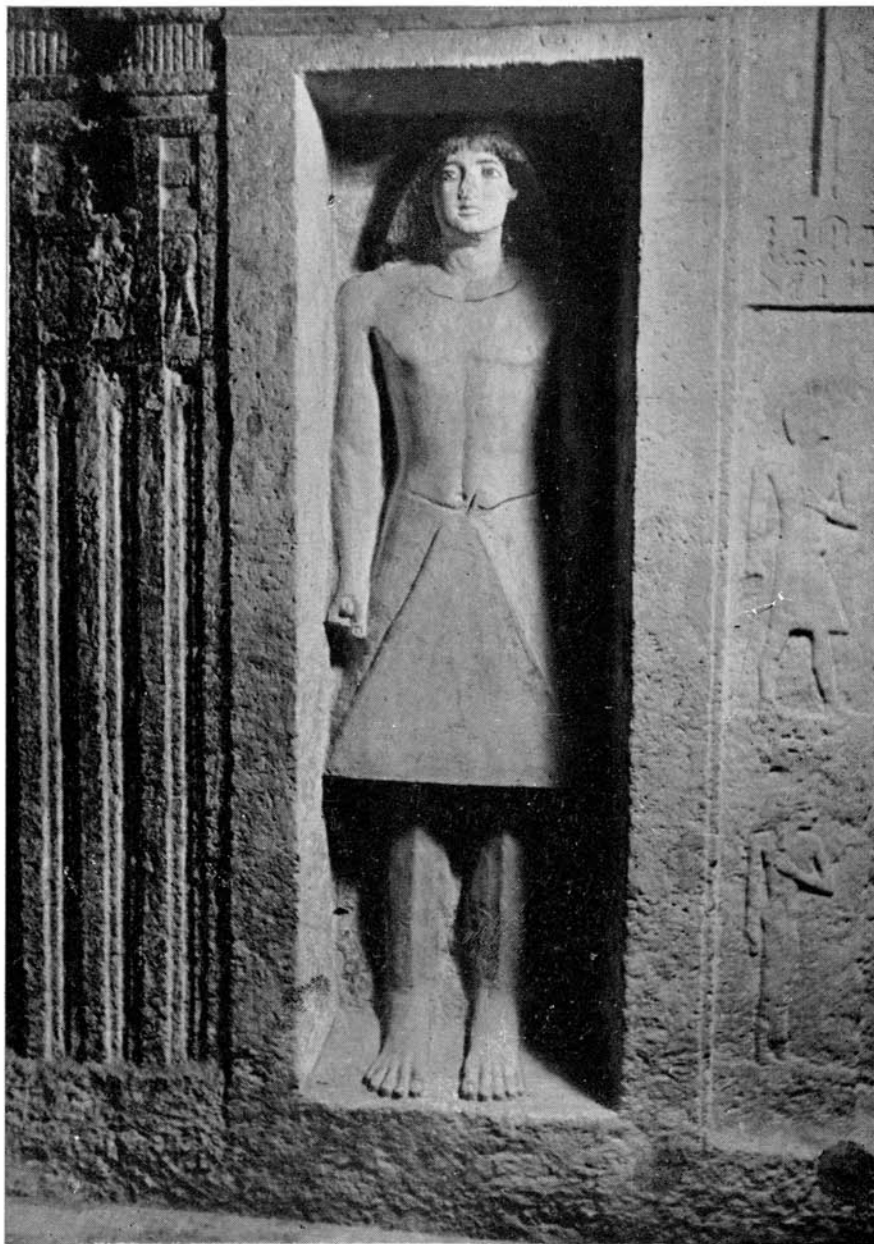
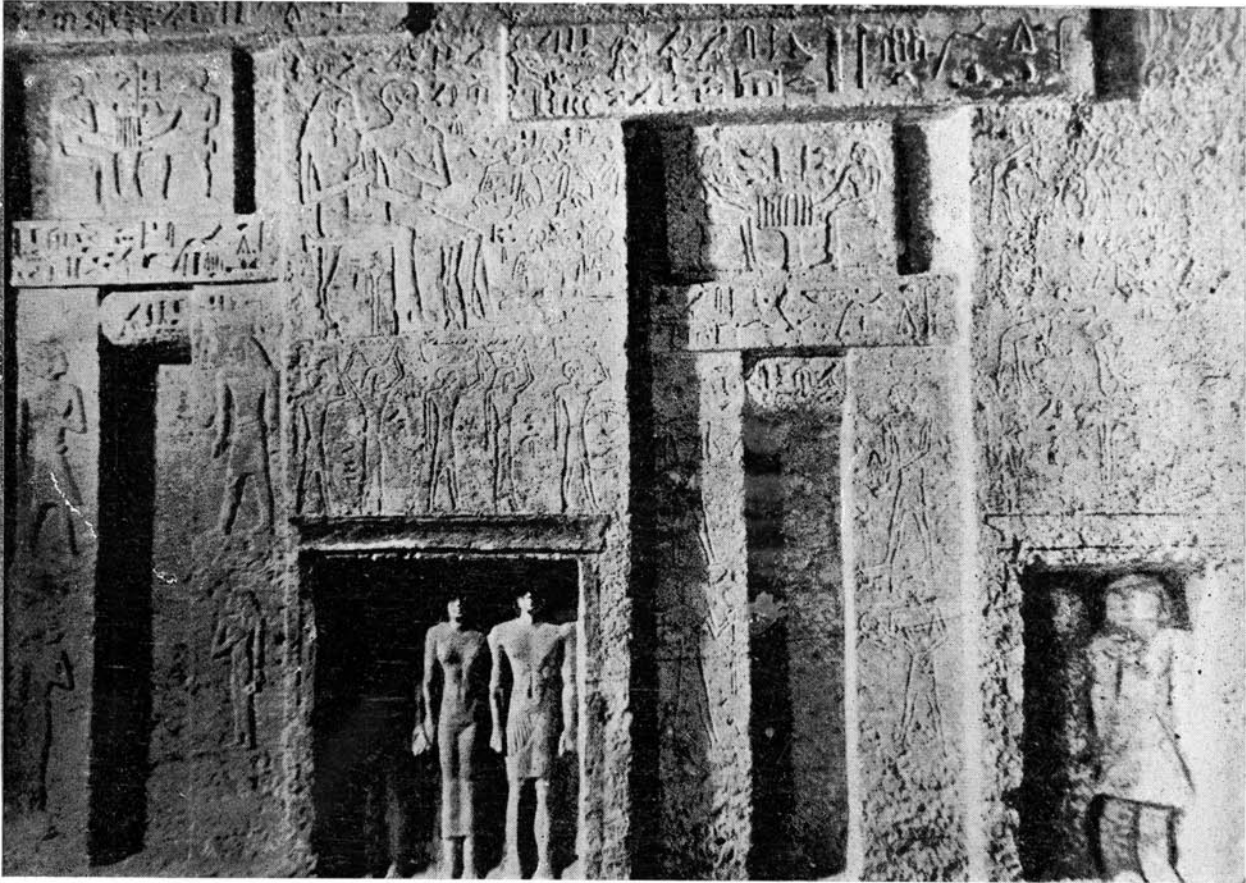


Figure hewn in the rock—southern part of the west wall

4

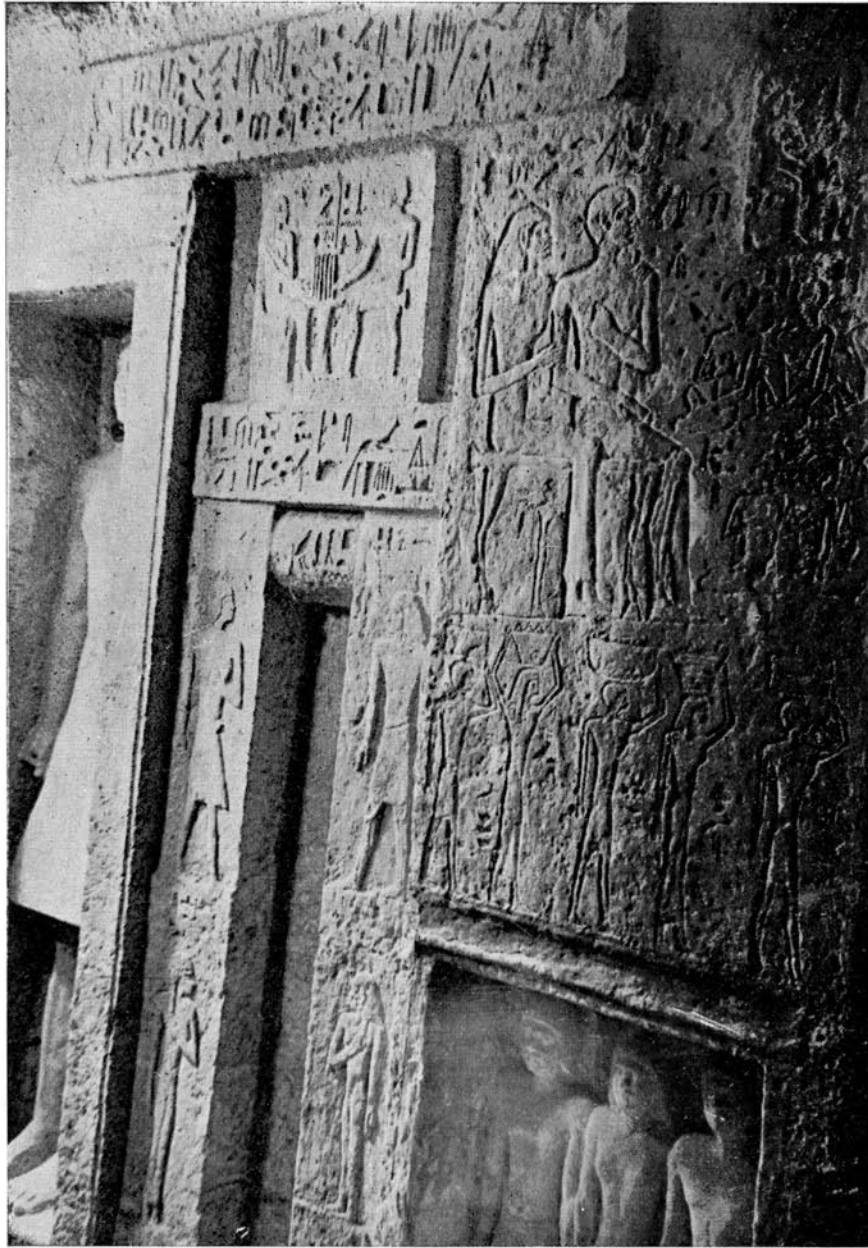


Two false-doors—west wall

B



Stand of the incense
pot in situ

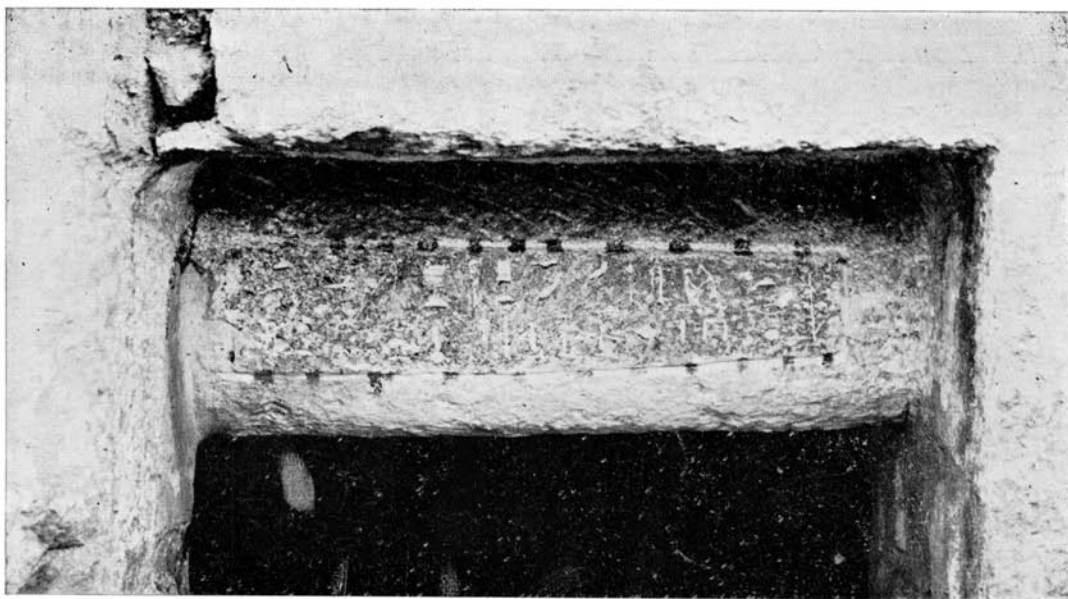


Scene on the west wall



Scenes of servants on duty. From the west wall

A



Drum above the entrance



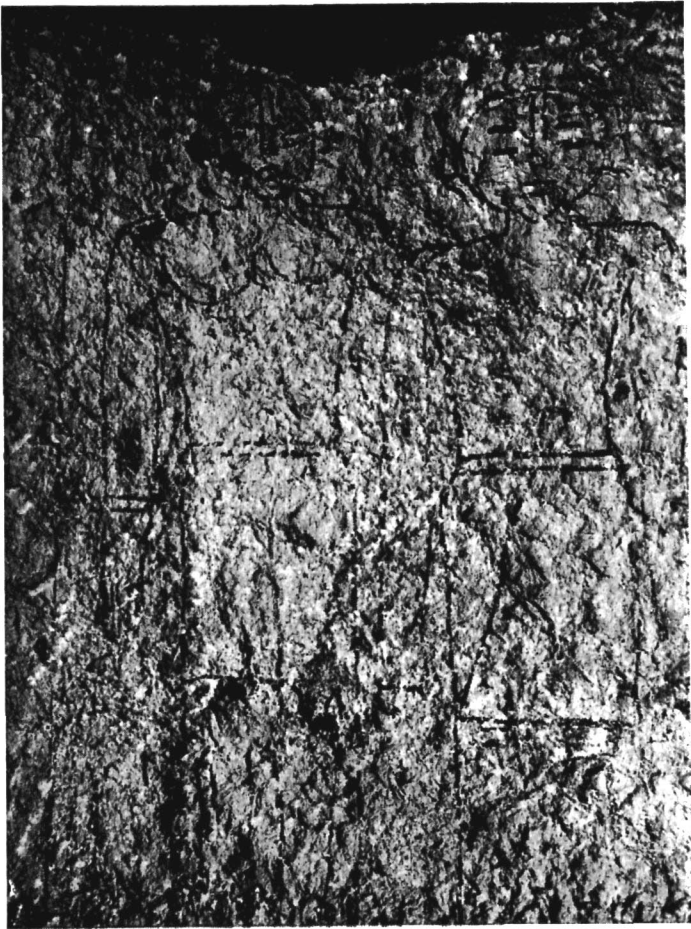
B

Scene on the right jamb

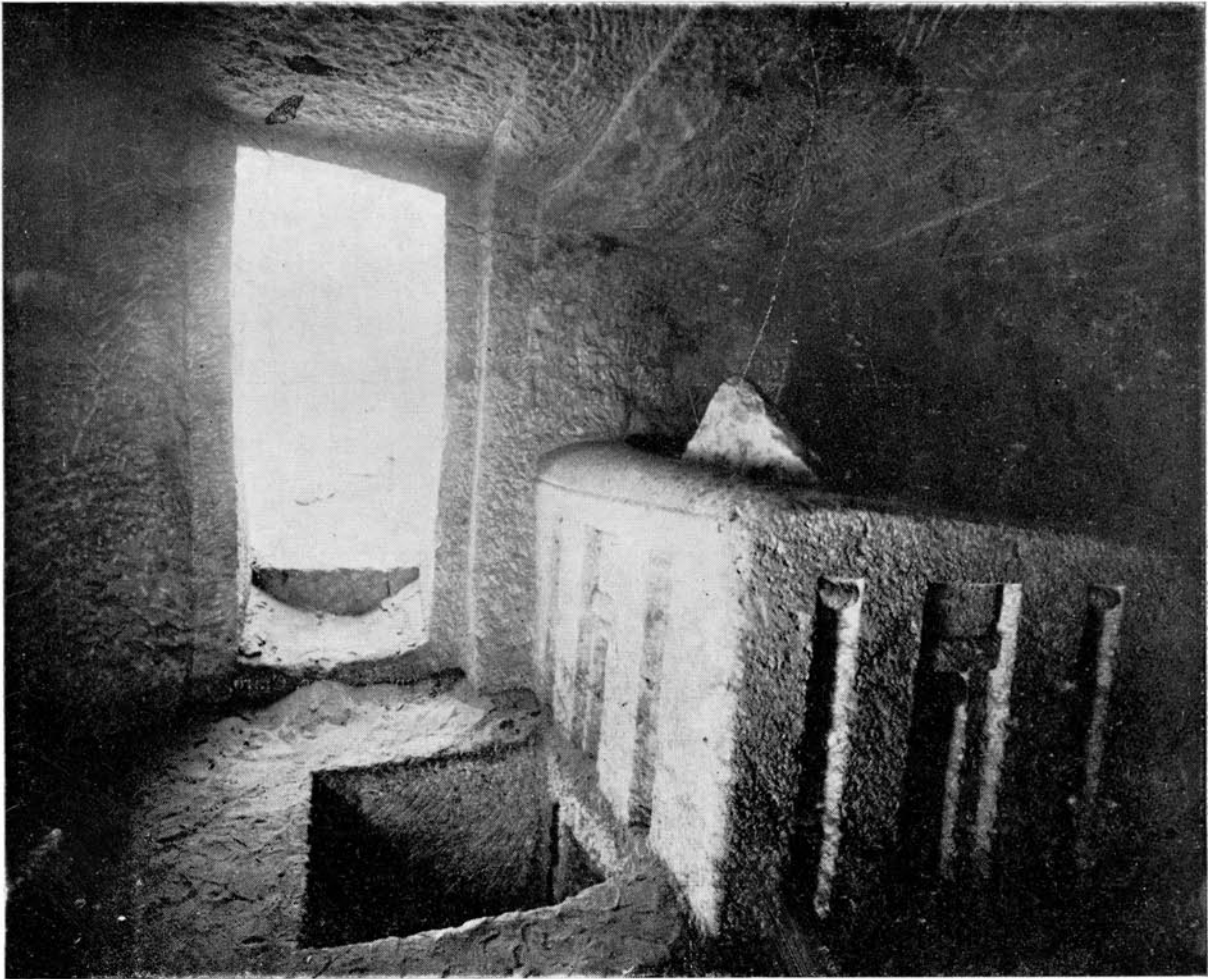
B



Scene on the left jamb



Scene on the east wall



Interior of the rock-tomb

Printed at the Government Press, Cairo,

Director.

HASSAN ALI KLEWA,